



ACE78LXXG

100mA Positive Voltage Regulator

Description

The ACE78LXXG series of positive regulators are available in the SOT-89-3 package and with 5V, 6V, 8V, 9V, 10V, 12V, 15V, 18V and 24V fixed output voltages, marking it useful in a wide range of applications. These regulators can provide local on-card regulation, eliminating the distribution problems associated with single point regulation. Each type employs internal current limiting, thermal shut-down and safe operating area protection, making it essentially indestructible. If adequate heat sinking is provided, they can deliver over 100mA output current. Although designed primarily as fixed voltage regulators, these devices can be used with external components to obtain adjustable voltages and currents. ACE78LXXG is characterized for operation from 0°C to +125°C.

Features

- Internal Short-Circuit Current Limiting
- Internal Thermal Overload Protection
- No External Components Required

Absolute Maximum Ratings

Parameter	Max	Unit	
Input Voltage	ACE78L05~10G	30	V
	ACE78L12~18G	35	
	ACE78L24G	40	
Output current	100	mA	
Operating junction temperature range	0 ~125	°C	
Storage temperature range	- 55 ~ 150	°C	
Power Dissipation	350*	mW	

* When tested in free air condition, without heat sinking.

Packaging Type

SOT-89-3

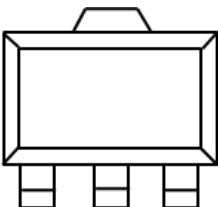

Vout GND Vin



ACE78LXXG

100mA Positive Voltage Regulator

Ordering information

ACE78L XX G XX + H



Typical Application

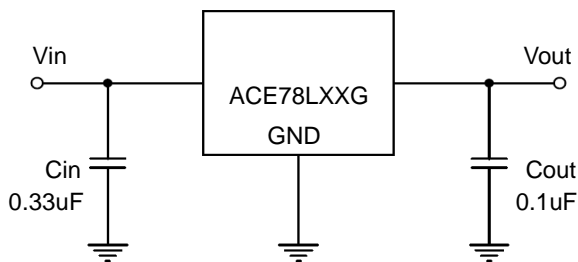

Electrical Characteristics

ACE78L05G (Refer to the test circuits, $T_J=0\sim 125^\circ\text{C}$, $I_O=40\text{mA}$, $V_{IN}=10\text{V}$, $C_{in}=0.33\mu\text{F}$, $C_o=0.1\mu\text{F}$ unless otherwise specified) (Note1)

Symbol		Test Condition	Min	Typ	Max	Unit
VO	B-Rank (5%)	$V_{IN}=10\text{V}$, $I_O=40\text{mA}$, $T_J=25^\circ\text{C}$ $7\text{V} \leq V_{IN} \leq 20\text{V}$, $1\text{mA} \leq I_O \leq 40\text{mA}$ $7\text{V} \leq V_{IN} \leq V_{max}$, $1\text{mA} \leq I_O \leq 70\text{mA}$ (Note2)	4.75		5.25	V
ΔV_O (Line Regulation)		$7\text{V} \leq V_{IN} \leq 20\text{V}$, $I_O=40\text{mA}$, $T_J=25^\circ\text{C}$		18	75	mV
		$8\text{V} \leq V_{IN} \leq 20\text{V}$, $I_O=40\text{mA}$, $T_J=25^\circ\text{C}$		10	54	
ΔV_O (Load Regulation)		$V_{IN}=10\text{V}$, $1\text{mA} \leq I_O \leq 100\text{mA}$, $T_J=25^\circ\text{C}$		20	60	mV
		$V_{IN}=10\text{V}$, $1\text{mA} \leq I_O \leq 40\text{mA}$, $T_J=25^\circ\text{C}$		5	30	
IQ		$V_{IN}=10\text{V}$, $I_O=0\text{mA}$, $T_J=25^\circ\text{C}$		3.0	5.0	mA
ΔI_Q		$V_{IN}=10\text{V}$, $1\text{mA} \leq I_O \leq 40\text{mA}$			0.1	mA
		$8\text{V} \leq V_{IN} \leq 20\text{V}$, $I_O=40\text{mA}$			1.0	
Vn		$10\text{Hz} \leq f \leq 100\text{KHz}$		40		μV
RR		$8\text{V} \leq V_{IN} \leq 20\text{V}$, $I_O=40\text{mA}$, $f=120\text{Hz}$, $T_J=25^\circ\text{C}$	47	62		dB
VD		$I_O=100\text{mA}$, $T_J=25^\circ\text{C}$		1.7		V
$\Delta V_O / \Delta T_J$		$I_O=5\text{mA}$, $0^\circ\text{C} \leq T_J \leq 125^\circ\text{C}$		-0.65		$\text{mV}/^\circ\text{C}$



ACE78LXXG

100mA Positive Voltage Regulator

ACE78L06G (Refer to the test circuits, $T_J=0\sim 125^\circ\text{C}$, $I_O=40\text{mA}$, $V_{IN}=12\text{V}$, $C_{in}=0.33\mu\text{F}$, $C_o=0.1\mu\text{F}$ unless otherwise specified) (Note1)

Symbol		Test Condition	Min	Typ	Max	Unit
VO	B-Rank (5%)	$V_{IN}=12\text{V}$, $I_O=40\text{mA}$, $T_J=25^\circ\text{C}$ $8.5\text{V} \leq V_{IN} \leq 20\text{V}$, $1\text{mA} \leq I_O \leq 40\text{mA}$ $8.5\text{V} \leq V_{IN} \leq V_{max}$, $1\text{mA} \leq I_O \leq 70\text{mA}$ (Note2)	5.70		6.30	V
ΔVO (Line Regulation)		$8.5\text{V} \leq V_{IN} \leq 20\text{V}$, $I_O=40\text{mA}$, $T_J=25^\circ\text{C}$		65	175	mV
		$9\text{V} \leq V_{IN} \leq 20\text{V}$, $I_O=40\text{mA}$, $T_J=25^\circ\text{C}$		54	125	
ΔVO (Load Regulation)		$V_{IN}=12\text{V}$, $1\text{mA} \leq I_O \leq 100\text{mA}$, $T_J=25^\circ\text{C}$		12.8	80	mV
		$V_{IN}=12\text{V}$, $1\text{mA} \leq I_O \leq 70\text{mA}$, $T_J=25^\circ\text{C}$		5.8	40	
IQ		$V_{IN}=12\text{V}$, $I_O=0\text{mA}$, $T_J=25^\circ\text{C}$		3.9	6.0	mA
ΔIQ		$V_{IN}=12\text{V}$, $1\text{mA} \leq I_O \leq 40\text{mA}$			0.1	mA
		$9\text{V} \leq V_{IN} \leq 20\text{V}$, $I_O=40\text{mA}$			1.5	
Vn		$10\text{Hz} \leq f \leq 100\text{KHz}$		49		μV
RR		$10\text{V} \leq V_{IN} \leq 20\text{V}$, $I_O=40\text{mA}$, $f=120\text{Hz}$, $T_J=25^\circ\text{C}$	40	46		dB
VD		$I_O=100\text{mA}$, $T_J=25^\circ\text{C}$		1.7		V
$\Delta V_O/\Delta T_J$		$I_O=5\text{mA}$, $0^\circ\text{C} \leq T_J \leq 125^\circ\text{C}$		0.75		$\text{mV}/^\circ\text{C}$

ACE78L08G (Refer to the test circuits, $T_J=0\sim 125^\circ\text{C}$, $I_O=40\text{mA}$, $V_{IN}=14\text{V}$, $C_{in}=0.33\mu\text{F}$, $C_o=0.1\mu\text{F}$ unless otherwise specified) (Note1)

Symbol		Test Condition	Min	Typ	Max	Unit
VO	B-Rank (5%)	$V_{IN}=14\text{V}$, $I_O=40\text{mA}$, $T_J=25^\circ\text{C}$ $10.5\text{V} \leq V_{IN} \leq 23\text{V}$, $1\text{mA} \leq I_O \leq 40\text{mA}$ $10.5\text{V} \leq V_{IN} \leq V_{max}$, $1\text{mA} \leq I_O \leq 70\text{mA}$ (Note2)	7.60		8.40	V
ΔVO (Line Regulation)		$10.5\text{V} \leq V_{IN} \leq 23\text{V}$, $I_O=40\text{mA}$, $T_J=25^\circ\text{C}$		10	175	mV
		$11\text{V} \leq V_{IN} \leq 23\text{V}$, $I_O=40\text{mA}$, $T_J=25^\circ\text{C}$		8	125	
ΔVO (Load Regulation)		$V_{IN}=14\text{V}$, $1\text{mA} \leq I_O \leq 100\text{mA}$, $T_J=25^\circ\text{C}$		15	80	mV
		$V_{IN}=14\text{V}$, $1\text{mA} \leq I_O \leq 70\text{mA}$, $T_J=25^\circ\text{C}$		8	40	
IQ		$V_{IN}=14\text{V}$, $I_O=0\text{mA}$, $T_J=25^\circ\text{C}$		2.0	5.5	mA
ΔIQ		$V_{IN}=14\text{V}$, $1\text{mA} \leq I_O \leq 40\text{mA}$			0.1	mA
		$11\text{V} \leq V_{IN} \leq 23\text{V}$, $I_O=40\text{mA}$			1.5	
Vn		$10\text{Hz} \leq f \leq 100\text{KHz}$		49		μV
RR		$11\text{V} \leq V_{IN} \leq 21\text{V}$, $I_O=40\text{mA}$, $f=120\text{Hz}$, $T_J=25^\circ\text{C}$	39	45		dB
VD		$I_O=100\text{mA}$, $T_J=25^\circ\text{C}$		1.7		V
$\Delta V_O/\Delta T_J$		$I_O=5\text{mA}$, $0^\circ\text{C} \leq T_J \leq 125^\circ\text{C}$		0.75		$\text{mV}/^\circ\text{C}$



ACE78LXXG

100mA Positive Voltage Regulator

ACE78L09G (Refer to the test circuits, $T_J=0\sim 125^\circ\text{C}$, $I_O=40\text{mA}$, $V_{IN}=15\text{V}$, $C_{in}=0.33\mu\text{F}$, $C_o=0.1\mu\text{F}$ unless otherwise specified) (Note1)

Symbol		Test Condition	Min	Typ	Max	Unit
VO	B-Rank (5%)	$V_{IN}=15\text{V}$, $I_O=40\text{mA}$, $T_J=25^\circ\text{C}$ $11.5\text{V} \leq V_{IN} \leq 24\text{V}$, $1\text{mA} \leq I_O \leq 40\text{mA}$ $11.5\text{V} \leq V_{IN} \leq V_{max}$, $1\text{mA} \leq I_O \leq 70\text{mA}$ (Note2)	8.55		9.45	V
ΔVO (Line Regulation)		$11.5\text{V} \leq V_{IN} \leq 24\text{V}$, $I_O=40\text{mA}$, $T_J=25^\circ\text{C}$		90	200	mV
		$13\text{V} \leq V_{IN} \leq 24\text{V}$, $I_O=40\text{mA}$, $T_J=25^\circ\text{C}$		100	150	
ΔVO (Load Regulation)		$V_{IN}=15\text{V}$, $1\text{mA} \leq I_O \leq 100\text{mA}$, $T_J=25^\circ\text{C}$		20	90	mV
		$V_{IN}=15\text{V}$, $1\text{mA} \leq I_O \leq 40\text{mA}$, $T_J=25^\circ\text{C}$		10	45	
IQ		$V_{IN}=15\text{V}$, $I_O=0\text{mA}$, $T_J=25^\circ\text{C}$		2.0	6.0	mA
ΔIQ		$V_{IN}=15\text{V}$, $1\text{mA} \leq I_O \leq 40\text{mA}$			0.1	mA
		$13\text{V} \leq V_{IN} \leq 24\text{V}$, $I_O=40\text{mA}$			1.5	
Vn		$10\text{Hz} \leq f \leq 100\text{KHz}$		49		μV
RR		$12\text{V} \leq V_{IN} \leq 23\text{V}$, $I_O=40\text{mA}$, $f=120\text{Hz}$, $T_J=25^\circ\text{C}$	38	44		dB
VD		$I_O=100\text{mA}$, $T_J=25^\circ\text{C}$		1.7		V
$\Delta V_O / \Delta T_J$		$I_O=5\text{mA}$, $0^\circ\text{C} \leq T_J \leq 125^\circ\text{C}$		0.75		$\text{mV}/^\circ\text{C}$

ACE78L10G (Refer to the test circuits, $T_J=0\sim 125^\circ\text{C}$, $I_O=40\text{mA}$, $V_{IN}=17\text{V}$, $C_{in}=0.33\mu\text{F}$, $C_o=0.1\mu\text{F}$ unless otherwise specified) (Note1)

Symbol		Test Condition	Min	Typ	Max	Unit
VO	B-Rank (5%)	$V_{IN}=17\text{V}$, $I_O=40\text{mA}$, $T_J=25^\circ\text{C}$ $13\text{V} \leq V_{IN} \leq 25\text{V}$, $1\text{mA} \leq I_O \leq 40\text{mA}$ $13\text{V} \leq V_{IN} \leq V_{max}$, $1\text{mA} \leq I_O \leq 70\text{mA}$ (Note2)	9.50		10.5	V
ΔVO (Line Regulation)		$13\text{V} \leq V_{IN} \leq 25\text{V}$, $I_O=40\text{mA}$, $T_J=25^\circ\text{C}$		51	175	mV
		$14\text{V} \leq V_{IN} \leq 25\text{V}$, $I_O=40\text{mA}$, $T_J=25^\circ\text{C}$		42	125	
ΔVO (Load Regulation)		$V_{IN}=17\text{V}$, $1\text{mA} \leq I_O \leq 100\text{mA}$, $T_J=25^\circ\text{C}$		20	90	mV
		$V_{IN}=17\text{V}$, $1\text{mA} \leq I_O \leq 40\text{mA}$, $T_J=25^\circ\text{C}$		11	40	
IQ		$V_{IN}=17\text{V}$, $I_O=0\text{mA}$, $T_J=25^\circ\text{C}$		4.2	6.0	mA
ΔIQ		$V_{IN}=17\text{V}$, $1\text{mA} \leq I_O \leq 40\text{mA}$			0.1	mA
		$14\text{V} \leq V_{IN} \leq 25\text{V}$, $I_O=40\text{mA}$			1.5	
Vn		$10\text{Hz} \leq f \leq 100\text{KHz}$		62		μV
RR		$15\text{V} \leq V_{IN} \leq 25\text{V}$, $I_O=40\text{mA}$, $f=120\text{Hz}$, $T_J=25^\circ\text{C}$	37	44		dB
VD		$I_O=100\text{mA}$, $T_J=25^\circ\text{C}$		1.7		V



ACE78LXXG

100mA Positive Voltage Regulator

ACE78L12G (Refer to the test circuits, $T_J=0\sim 125^\circ\text{C}$, $I_O=40\text{mA}$, $V_{IN}=19\text{V}$, $C_{in}=0.33\mu\text{F}$, $C_o=0.1\mu\text{F}$ unless otherwise specified) (Note1)

Symbol		Test Condition	Min	Typ	Max	Unit
VO	B-Rank (5%)	$V_{IN}=19\text{V}$, $I_O=40\text{mA}$, $T_J=25^\circ\text{C}$ $14.5\text{V} \leq V_{IN} \leq 27\text{V}$, $1\text{mA} \leq I_O \leq 40\text{mA}$ $14.5\text{V} \leq V_{IN} \leq V_{max}$, $1\text{mA} \leq I_O \leq 70\text{mA}$ (Note2)	11.40		12.60	V
ΔVO (Line Regulation)		$14.5\text{V} \leq V_{IN} \leq 27\text{V}$, $I_O=40\text{mA}$, $T_J=25^\circ\text{C}$		25	300	mV
		$16\text{V} \leq V_{IN} \leq 27\text{V}$, $I_O=40\text{mA}$, $T_J=25^\circ\text{C}$		20	250	
ΔVO (Load Regulation)		$V_{IN}=19\text{V}$, $1\text{mA} \leq I_O \leq 100\text{mA}$, $T_J=25^\circ\text{C}$		25	150	mV
		$V_{IN}=19\text{V}$, $1\text{mA} \leq I_O \leq 40\text{mA}$, $T_J=25^\circ\text{C}$		12	75	
IQ		$V_{IN}=19\text{V}$, $I_O=0\text{mA}$, $T_J=25^\circ\text{C}$		2.0	6.0	mA
ΔIQ		$V_{IN}=19\text{V}$, $1\text{mA} \leq I_O \leq 40\text{mA}$			0.1	mA
		$16\text{V} \leq V_{IN} \leq 27\text{V}$, $I_O=40\text{mA}$			1.5	
Vn		$10\text{Hz} \leq f \leq 100\text{KHz}$		80		μV
RR		$15\text{V} \leq V_{IN} \leq 25\text{V}$, $I_O=40\text{mA}$, $f=120\text{Hz}$, $T_J=25^\circ\text{C}$	37	65		dB
VD		$I_O=100\text{mA}$, $T_J=25^\circ\text{C}$		1.7		V
$\Delta V_O / \Delta T_J$		$I_O=5\text{mA}$, $0^\circ\text{C} \leq T_J \leq 125^\circ\text{C}$		-1.0		$\text{mV}/^\circ\text{C}$

ACE78L15G (Refer to the test circuits, $T_J=0\sim 125^\circ\text{C}$, $I_O=40\text{mA}$, $V_{IN}=23\text{V}$, $C_{in}=0.33\mu\text{F}$, $C_o=0.1\mu\text{F}$ unless otherwise specified) (Note1)

Symbol		Test Condition	Min	Typ	Max	Unit
VO	B-Rank (5%)	$V_{IN}=23\text{V}$, $I_O=40\text{mA}$, $T_J=25^\circ\text{C}$ $17.5\text{V} \leq V_{IN} \leq 30\text{V}$, $1\text{mA} \leq I_O \leq 40\text{mA}$ $17.5\text{V} \leq V_{IN} \leq V_{max}$, $1\text{mA} \leq I_O \leq 70\text{mA}$ (Note2)	14.25		15.75	V
ΔVO (Line Regulation)		$17.5\text{V} \leq V_{IN} \leq 30\text{V}$, $I_O=40\text{mA}$, $T_J=25^\circ\text{C}$		25	150	mV
		$20\text{V} \leq V_{IN} \leq 30\text{V}$, $I_O=40\text{mA}$, $T_J=25^\circ\text{C}$		15	75	
ΔVO (Load Regulation)		$V_{IN}=23\text{V}$, $1\text{mA} \leq I_O \leq 100\text{mA}$, $T_J=25^\circ\text{C}$		20	150	mV
		$V_{IN}=23\text{V}$, $1\text{mA} \leq I_O \leq 70\text{mA}$, $T_J=25^\circ\text{C}$		25	150	
IQ		$V_{IN}=23\text{V}$, $I_O=0\text{mA}$, $T_J=25^\circ\text{C}$		2.2	6.5	mA
ΔIQ		$V_{IN}=23\text{V}$, $1\text{mA} \leq I_O \leq 40\text{mA}$			0.1	mA
		$20\text{V} \leq V_{IN} \leq 30\text{V}$, $I_O=40\text{mA}$			1.5	
Vn		$10\text{Hz} \leq f \leq 100\text{KHz}$		90		μV
RR		$18.5\text{V} \leq V_{IN} \leq 28.5\text{V}$, $I_O=40\text{mA}$, $f=120\text{Hz}$, $T_J=25^\circ\text{C}$	34	63		dB
VD		$I_O=100\text{mA}$, $T_J=25^\circ\text{C}$		1.7		V
$\Delta V_O / \Delta T_J$		$I_O=5\text{mA}$, $0^\circ\text{C} \leq T_J \leq 125^\circ\text{C}$		-1.3		$\text{mV}/^\circ\text{C}$



ACE78LXXG

100mA Positive Voltage Regulator

ACE78L18G (Refer to the test circuits, $T_J=0\sim 125^\circ\text{C}$, $I_O=40\text{mA}$, $V_{IN}=27\text{V}$, $C_{in}=0.33\mu\text{F}$, $C_o=0.1\mu\text{F}$ unless otherwise specified) (Note1)

Symbol		Test Condition	Min	Typ	Max	Unit
VO	B-Rank (5%)	$V_{IN}=27\text{V}$, $I_O=40\text{mA}$, $T_J=25^\circ\text{C}$ $21\text{V} \leq V_{IN} \leq 33\text{V}$, $1\text{mA} \leq I_O \leq 40\text{mA}$ $21\text{V} \leq V_{IN} \leq V_{max}$, $1\text{mA} \leq I_O \leq 70\text{mA}$ (Note2)	17.10		18.9	V
ΔVO (Line Regulation)		$21\text{V} \leq V_{IN} \leq 33\text{V}$, $I_O=40\text{mA}$, $T_J=25^\circ\text{C}$		145	300	mV
		$22\text{V} \leq V_{IN} \leq 33\text{V}$, $I_O=40\text{mA}$, $T_J=25^\circ\text{C}$		135	250	
ΔVO (Load Regulation)		$V_{IN}=27\text{V}$, $1\text{mA} \leq I_O \leq 100\text{mA}$, $T_J=25^\circ\text{C}$		30	170	mV
		$V_{IN}=27\text{V}$, $1\text{mA} \leq I_O \leq 40\text{mA}$, $T_J=25^\circ\text{C}$		15	85	
IQ		$V_{IN}=27\text{V}$, $I_O=0\text{mA}$, $T_J=25^\circ\text{C}$		2.0	6.0	mA
ΔIQ		$V_{IN}=27\text{V}$, $1\text{mA} \leq I_O \leq 40\text{mA}$			0.1	mA
		$21\text{V} \leq V_{IN} \leq 33\text{V}$, $I_O=40\text{mA}$			1.5	
Vn		$10\text{Hz} \leq f \leq 100\text{KHz}$		150		μV
RR		$23\text{V} \leq V_{IN} \leq 33\text{V}$, $I_O=40\text{mA}$, $f=120\text{Hz}$, $T_J=25^\circ\text{C}$	34	48		dB
VD		$I_O=100\text{mA}$, $T_J=25^\circ\text{C}$		1.7		V
$\Delta V_O/\Delta T_J$		$I_O=5\text{mA}$, $0^\circ\text{C} \leq T_J \leq 125^\circ\text{C}$		-1.8		$\text{mV}/^\circ\text{C}$

ACE78L24G (Refer to the test circuits, $T_J=0\sim 125^\circ\text{C}$, $I_O=40\text{mA}$, $V_{IN}=33\text{V}$, $C_{in}=0.33\mu\text{F}$, $C_o=0.1\mu\text{F}$ unless otherwise specified) (Note1)

Symbol		Test Condition	Min	Typ	Max	Unit
VO	B-Rank (5%)	$V_{IN}=33\text{V}$, $I_O=40\text{mA}$, $T_J=25^\circ\text{C}$ $27\text{V} \leq V_{IN} \leq 38\text{V}$, $1\text{mA} \leq I_O \leq 40\text{mA}$ $27\text{V} \leq V_{IN} \leq V_{max}$, $1\text{mA} \leq I_O \leq 70\text{mA}$ (Note2)	22.80		25.20	V
ΔVO (Line Regulation)		$27\text{V} \leq V_{IN} \leq 38\text{V}$, $I_O=40\text{mA}$, $T_J=25^\circ\text{C}$		160	300	mV
		$28\text{V} \leq V_{IN} \leq 38\text{V}$, $I_O=40\text{mA}$, $T_J=25^\circ\text{C}$		150	250	
ΔVO (Load Regulation)		$V_{IN}=33\text{V}$, $1\text{mA} \leq I_O \leq 100\text{mA}$, $T_J=25^\circ\text{C}$		40	200	mV
		$V_{IN}=33\text{V}$, $1\text{mA} \leq I_O \leq 40\text{mA}$, $T_J=25^\circ\text{C}$		20	100	
IQ		$V_{IN}=33\text{V}$, $I_O=0\text{mA}$, $T_J=25^\circ\text{C}$		2.2	6.0	mA
ΔIQ		$V_{IN}=33\text{V}$, $1\text{mA} \leq I_O \leq 40\text{mA}$			0.1	mA
		$27\text{V} \leq V_{IN} \leq 38\text{V}$, $I_O=40\text{mA}$			1.5	
Vn		$10\text{Hz} \leq f \leq 100\text{KHz}$		200		μV
RR		$27\text{V} \leq V_{IN} \leq 38\text{V}$, $I_O=40\text{mA}$, $f=120\text{Hz}$, $T_J=25^\circ\text{C}$	34	45		dB
VD		$I_O=100\text{mA}$, $T_J=25^\circ\text{C}$		1.7		V
$\Delta V_O/\Delta T_J$		$I_O=5\text{mA}$, $0^\circ\text{C} \leq T_J \leq 125^\circ\text{C}$		-2.0		$\text{mV}/^\circ\text{C}$



ACE78LXXG

100mA Positive Voltage Regulator

Note 1: The Maximum steady state usable output current is dependent on input voltage, heat sinking, lead length of the package and copper of PCB. The data above represent pulse test conditions with junction temperatures specified at the initiation of test.

Note 2: Power dissipation < 0.5W.

Characteristics Curve

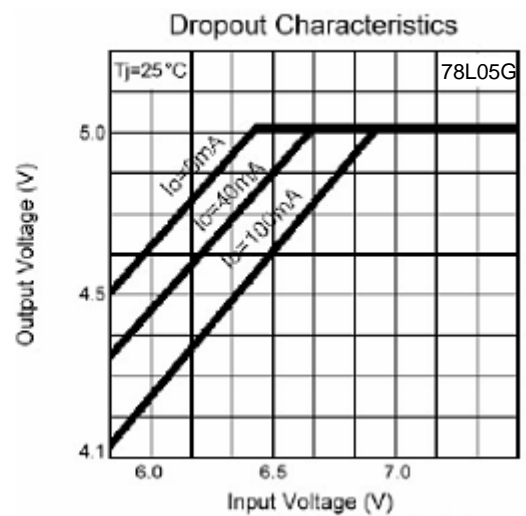
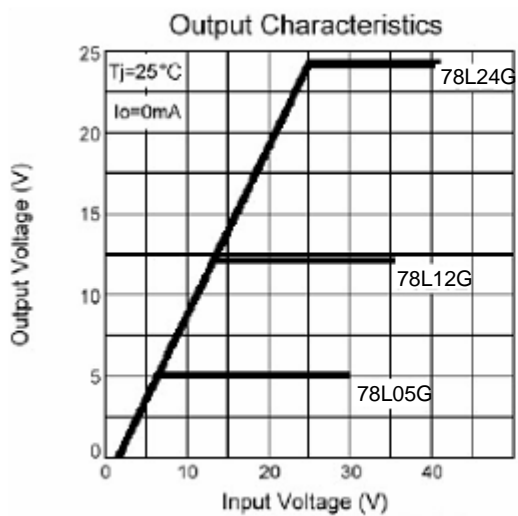
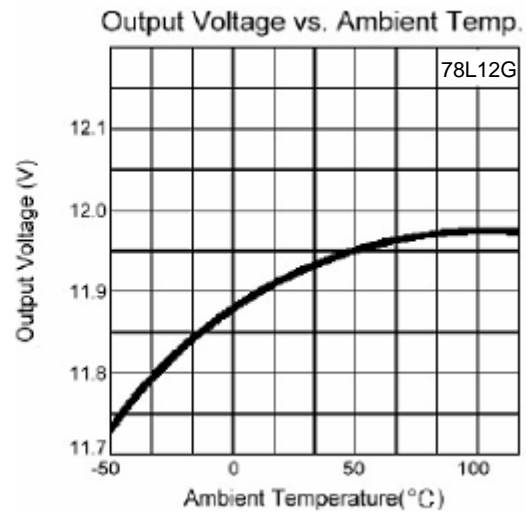
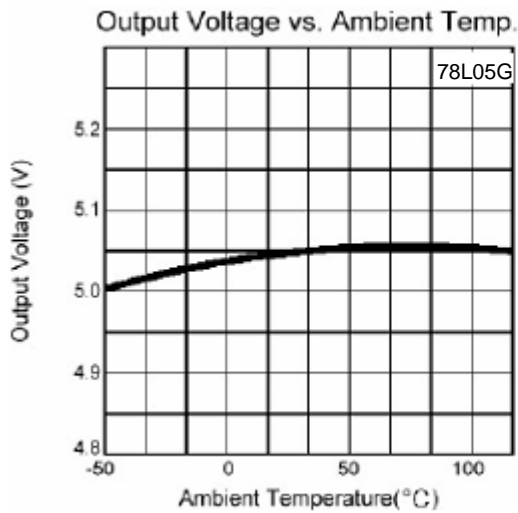



ACE78LXXG

100mA Positive Voltage Regulator

Quiescent Current vs. Output Current

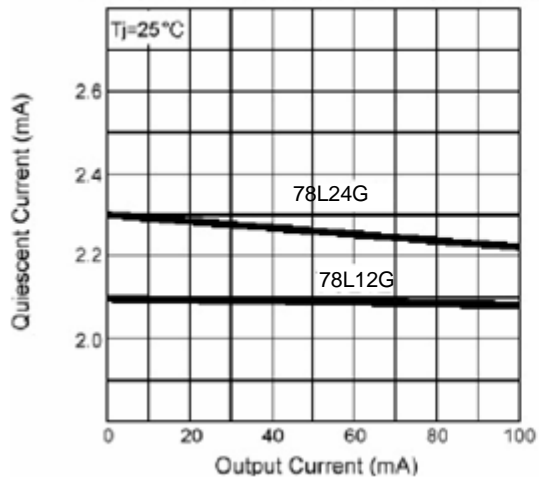

Quiescent Current vs. Input Voltage

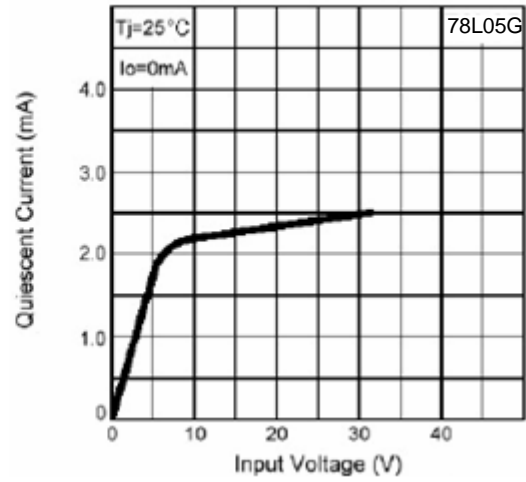



ACE78LXXG

100mA Positive Voltage Regulator

Packing Information

SOT-89-3

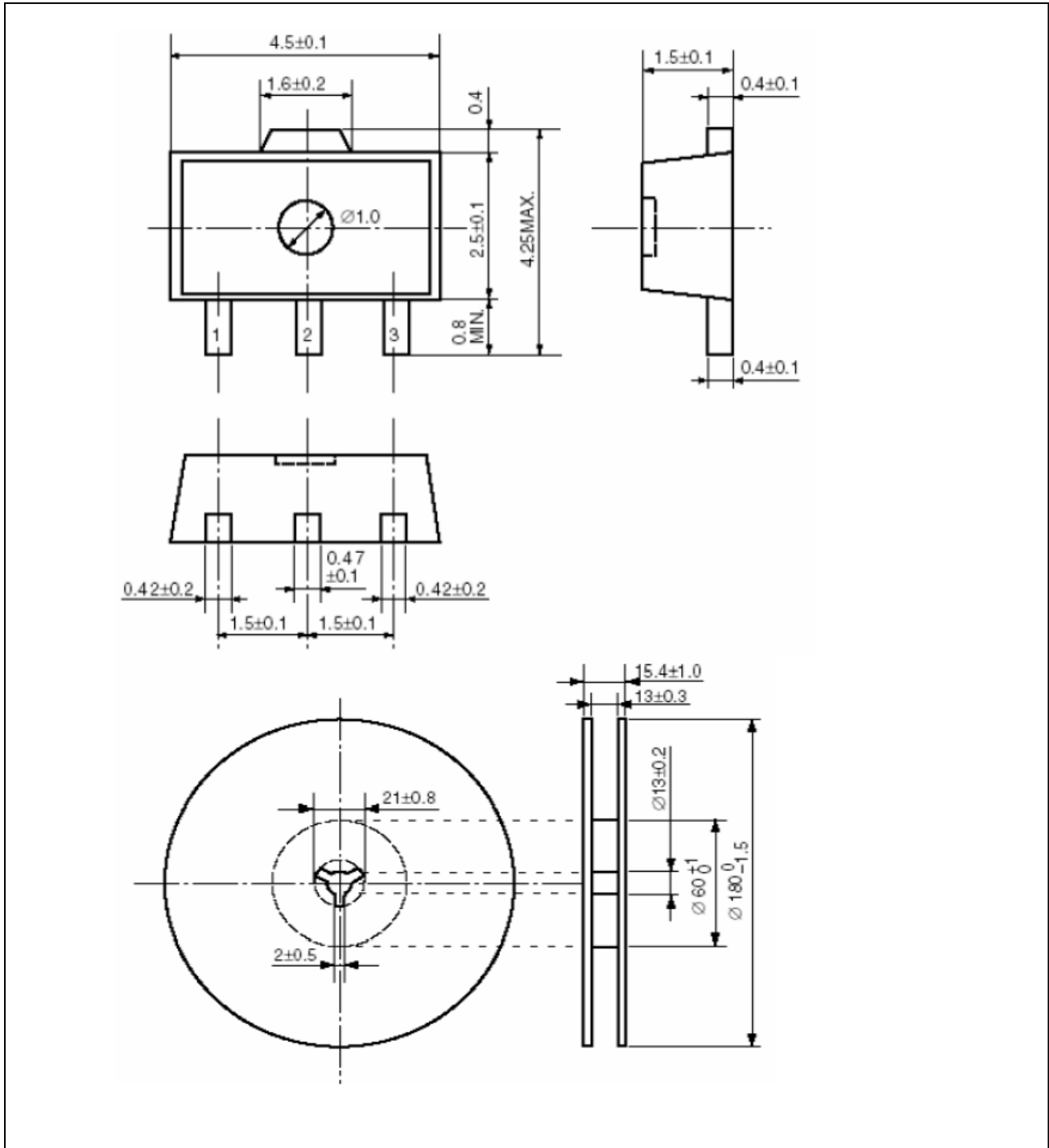



ACE78LXXG

100mA Positive Voltage Regulator

Notes

ACE does not assume any responsibility for use as critical components in life support devices or systems without the express written approval of the president and general counsel of ACE Electronics Co., LTD. As sued herein:

1. Life support devices or systems are devices or systems which, (a) are intended for surgical implant into the body, or (b) support or sustain life, and whose failure to perform when properly used in accordance with instructions for use provided in the labeling, can be reasonably expected to result in a significant injury to the user.
2. A critical component is any component of a life support device or system whose failure to perform can be reasonably expected to cause the failure of the life support device or system, or to affect its safety or effectiveness.

ACE Technology Co., LTD.
<http://www.ace-ele.com/>