

RoHS HF 437 Series – 1206 Fast-Acting Fuse

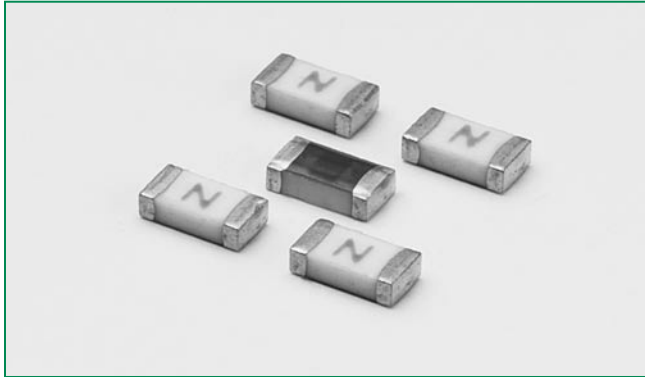



Description

This 100% Lead-free, RoHS compliant and Halogen-free fuse series has been designed specifically to provide over current protection to circuits that see high working ambient temperatures (up to 150°C).

The general design ensures excellent temperature stability and performance reliability.

In addition to this, the high I²t values typical of the Littelfuse Ceramic Fuse family ensure high inrush current withstand capability.

Agency Approvals

AGENCY	AGENCY FILE NUMBER	AMPERE RANGE
	E10480	0.250A ~ 8A
	LR29862	0.250A ~ 8A

Features

- Operating Temperature from -55°C to +150°C
- Suitable for both leaded and lead-free reflow / wave soldering
- 100% Lead-free and RoHS compliant



Electrical Characteristics for Series

% of Ampere Rating	Ampere Rating	Opening Time at 25°C
100%	250mA - 8A	4 hours, Minimum
250%	750mA - 8A	5 seconds, Maximum
350%	250mA - 500mA	5 seconds, Maximum
350%	750mA - 8A	1 second, Maximum

Applications

- Automotive Electronics
- LCD Displays
- Servers
- Printers
- Scanners
- Data Modems

Electrical Specifications by Item

Ampere Rating (A)	Amp Code	Max. Voltage Rating (V)	Interrupting Rating	Nominal Resistance (Ohms) ²	Nominal Melting I ² t (A ² Sec.) ³	Nominal Voltage Drop At Rated Current (V) ⁴	Nominal Power Dissipation At Rated Current (W)	Agency Approvals	
									
250mA	.250	125	50 A @ 125 V AC/DC	2.290	0.003	0.78	0.195	x	x
375mA	.375	125		1.330	0.010	0.60	0.225	x	x
500mA	.500	63		0.908	0.018	0.52	0.260	x	x
750mA	.750	63	50 A @ 63 V AC/DC	0.665	0.064	0.45	0.335	x	x
1A	001.	63		0.360	0.100	0.41	0.415	x	x
1.25A	1.25	63		0.318	0.256	0.40	0.496	x	x
1.5A	01.5	63		0.209	0.324	0.39	0.579	x	x
1.75A	1.75	63		0.0703	0.075	0.27	0.474	x	x
2A	002.	63		0.058	0.144	0.17	0.345	x	x
2.5A	02.5	32	50 A @ 32 V AC/35 V DC	0.043	0.225	0.14	0.363	x	x
3A	003.	32		0.033	0.400	0.15	0.462	x	x
3.5A	03.5	32		0.027	0.576	0.16	0.560	x	x
4A	004.	32		0.022	1.024	0.16	0.618	x	x
5A	005.	32		0.016	1.936	0.09	0.484	x	x
7A	007.	32		0.010	4.900	0.11	0.760	x	x
8A	008.	32		0.0084	6.400	0.067	0.539	x	x

Notes:

1. AC Interrupting Rating tested at rated voltage with unity power factor. DC Interrupting Rating tested at rated voltage with time constant < 0.8 msec.
2. Nominal Resistance measured with < 10% rated current.
3. Nominal Melting I²t measured at 1 msec. opening time.
4. Nominal Voltage Drop measured at rated current after temperature has stabilized.

Devices designed to carry rated current for 4 hours minimum. It is recommended that devices be operated continuously at no more than 80% rated current. See "Temperature Derating Curve" for additional derating information.

Devices designed to be mounted with marking code facing up.

Temperature Derating Curve

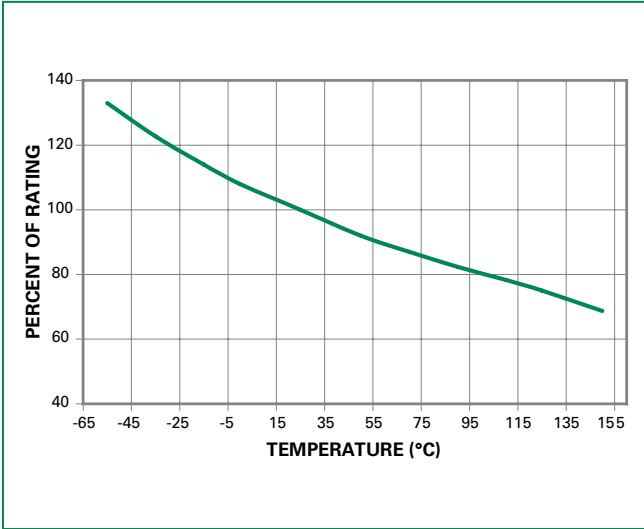

Note:

1. Derating depicted in this curve is in addition to the standard derating of 20% for continuous operation.

Example:

For continuous operation at 75 degrees celsius, the fuse should be derated as follows:

$$I = (0.80)(0.85)I_{RAT} = (0.68)I_{RAT}$$

Average Time Current Curves

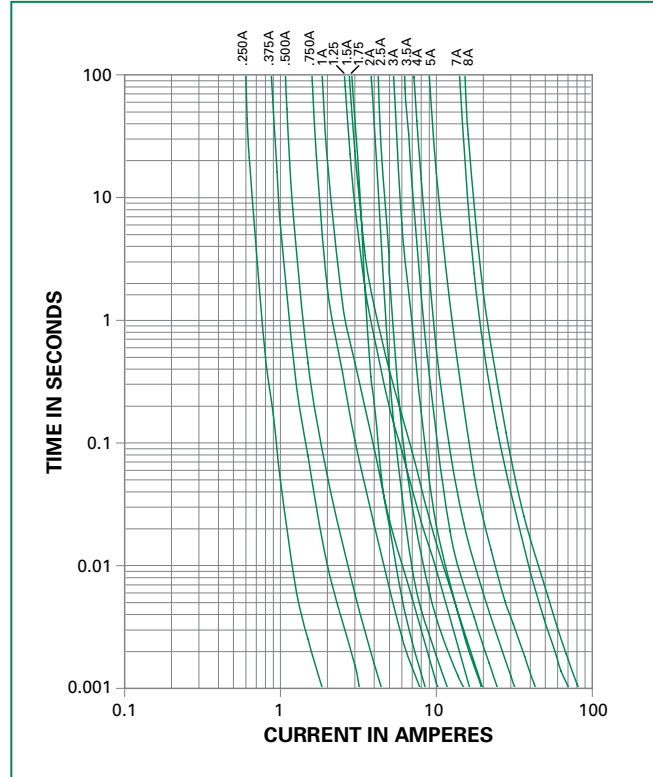

Soldering Parameters

Reflow Condition		Pb – free assembly
Pre Heat	- Temperature Min ($T_{s(min)}$)	150°C
	- Temperature Max ($T_{s(max)}$)	200°C
	- Time (Min to Max) (t_s)	60 – 180 seconds
Average Ramp-up Rate (Liquidus Temp (T_L) to peak)		3°C/second max.
$T_{s(max)}$ to T_L - Ramp-up Rate		5°C/second max.
Reflow	- Temperature (T_L) (Liquidus)	217°C
	- Temperature (t_L)	60 – 150 seconds
Peak Temperature (T_p)		260 ^{+0/-5} °C
Time within 5°C of actual peak Temperature (t_p)		10 – 30 seconds
Ramp-down Rate		6°C/second max.
Time 25°C to peak Temperature (T_p)		8 minutes max.
Do not exceed		260°C

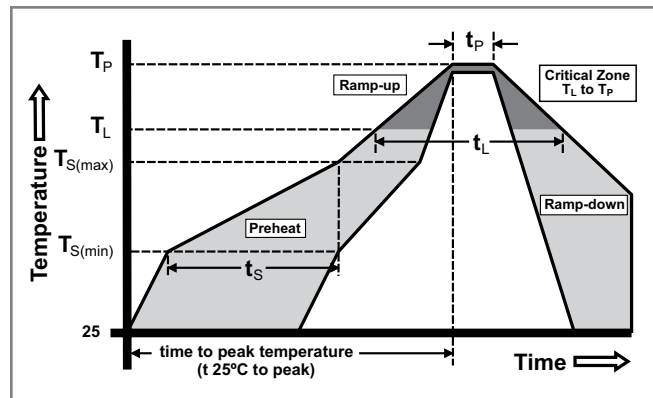

Wave Soldering	260°C, 10 seconds max.
----------------	------------------------

Product Characteristics

Materials	Body: Advanced Ceramic Terminations: Ag / Ni / Sn (100% Lead-free) Element Cover Coating: Lead-free Glass
Moisture Sensitivity Level	IPC/JEDEC J-STD-020C, Level 1
Solderability	IPC/EIC/JEDEC J-STD-002B, Condition B
Humidity Test	MIL-STD-202, Method 103B, Conditions D
Resistance to Solder Heat	MIL-STD-202, Method 210F, Condition B

Moisture Resistance	MIL-STD-202, Method 106G
Thermal Shock	MIL-STD-202, Method 107G, Condition B
Mechanical Shock	MIL-STD-202, Method 213B, Condition A
Vibration	MIL-STD-202, Method 201A
Vibration, High Frequency	MIL-STD-202, Method 204D, Condition D
Dissolution of Metallization	IPC/EIC/JEDEC J-STD-002B, Condition D
Terminal Strength	IEC 60127-4

Dimensions

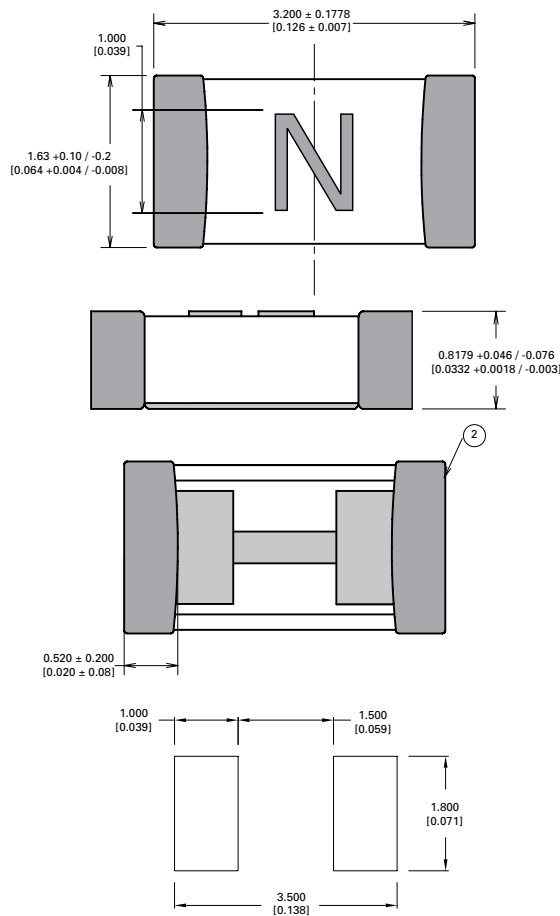

Part Marking System

Amp Code	Marking Code
.250	D
.375	E
.500	F
.750	G
001.	H
1.25	J
01.5	K
1.75	L
002.	N
02.5	O
003.	P
03.5	R
004.	S
005.	T
007.	W
008.	X

Part Numbering System

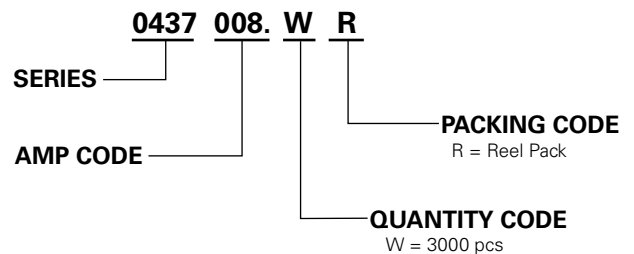

Packaging

Packaging Option	Packaging Specification	Quantity	Quantity & Packaging Code
8mm Tape and Reel	EIA-481, IEC 60286, Part 3	3000	WR