

KEY FEATURES

- Open Frame LED Power Supply
- With Constant Current & Constant Voltage (C.C+C.V mode)
- Dimming fuction:0~10VDC & PWM Duty Controlled
- Universal Input: 100-240 VAC
- With P.F.C. Function, PF>0.9
- Free Air Convection
- Protections: Over Load / Over Voltage / Short Circuit
- High Reliability & Double Layered PCB
- Ultra Compact Size: 4.0 x 2.0 x 1.12 Inches
- 3-Years Product Warranty



ELECTRICAL SPECIFICATIONS



All specifications valid at normal input voltage, full load and +25°C after warm-up time unless otherwise stated.

Model No.	ZQF30-13.5S	ZQF30-24S	ZQF30-48S
Max output wattage (W)	31.4W	33.6W	33.6W
Input	Voltage (Note2)		
	90-264 VAC		
	Frequency (Hz)		
	50 / 60 Hz		
	Power factor		
	PF>0.9 at Full load (115 VAC / 230 VAC)		
Output	Current (Full load)		
	0.4A max. (115 VAC) / 0.2A max. (230 VAC)		
	Inrush current		
	40 A max. (Cold Start at 230 VAC)		
	Leakage Current		
	< 0.7 mA max at 240 VAC / 63 Hz		
	Voltage (V.DC.)		
	13.5V 24V 48V		
Output	Constant Current Operation Voltage (max) (CC Mode) (Note3)		
	11~13.5VDC 18~ 24VDC 36~ 48VDC		
	Voltage Tolerance		
	±10%		
	Current Adjustment Range (mA) (CC Mode)		
	1700 ~ 2330 1050 ~ 1400 525 ~ 700		
	Minimum Load (mA)		
	1700 1050 525		
Protection	Line Regulation (115-230) (typ.)		
	±4%		
	Load Regulation (Min-Max) (typ.)		
±5%			
Protection	Ripple & Noise (max)		
	2.4Vp-p 2.4Vp-p 4.8Vp-p		
	Efficiency (at 230VAC.)(typ)		
85% 88% 89%			
Isolation	Over current protection		
	Auto recovery		
	Over voltage protection		
Zener diode clamp			
Isolation	Short circuit protection		
	Auto recovery		
	Input-Output (V.AC)		
3750V			
Isolation	Input-FG (V.AC)		
	1880V		
	Output-FG (V.AC)		
500V			
Environment	Operating temperature		
	-30°C...+70°C (with derating)		
	Storage temperature		
	-40°C...+85°C		
	Temperature coefficient		
0.02%/°C			
Physical	Humidity		
	95% RH		
	MTBF		
>583,000 h @ 25°C (MIL-HDBK-217F)			
Physical	Dimension (L x W x H)		
	4.0 x 2.0 x 1.12 Inches (101.6 x 50.8 x 28.5 mm) Tolerance ±0.5 mm		
	Weight		
165 g			
Safety	Cooling method		
	Free air convection		
EMC	Agency Approvals		
	IEC / EN 61347-2-13 、 IEC / EN 61347-1		
	EMI (Conducted & Radiated Emission)		
EN 55015			
EMC	EMS (Noise Immunity)		
	EN 61547		
Harmonic Current			
EN 61000-3-2(at Full Load) 、 EN 61000-3-3			

Note:

1. Ripple & Noise are measured at 20MHz of bandwidth with 0.1uF & 47uF parallel capacitor.
2. Please check the derating curve for more details.
3. Input Voltage=115 / 230 VAC. This is the suitable operation region for LED related application. but please reconfirm special electrical requirements for some specific ststem design.
4. CV mode only available in 115/230 VAC Input

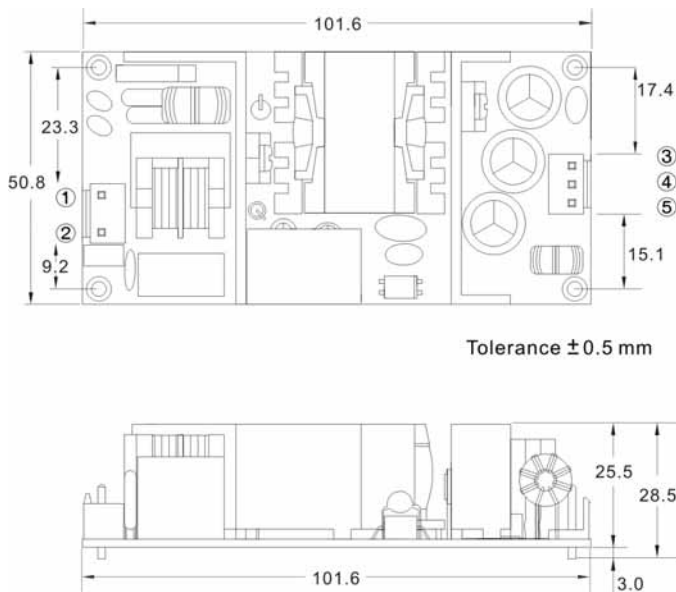
MECHANICAL DIMENSION (Top View)

PIN#	SINGLE
1	AC IN (N)
2	AC IN (L)
3	+Dim
4	+DC OUT
5	-DC OUT

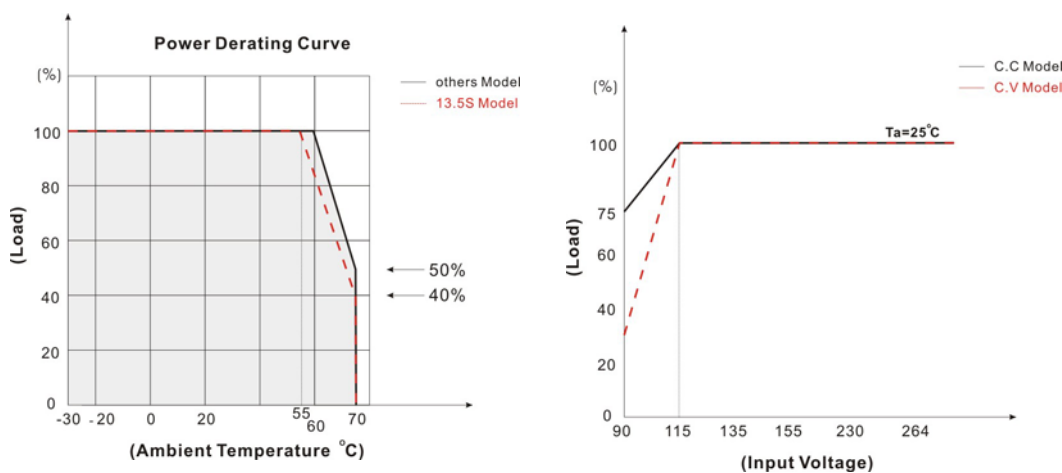
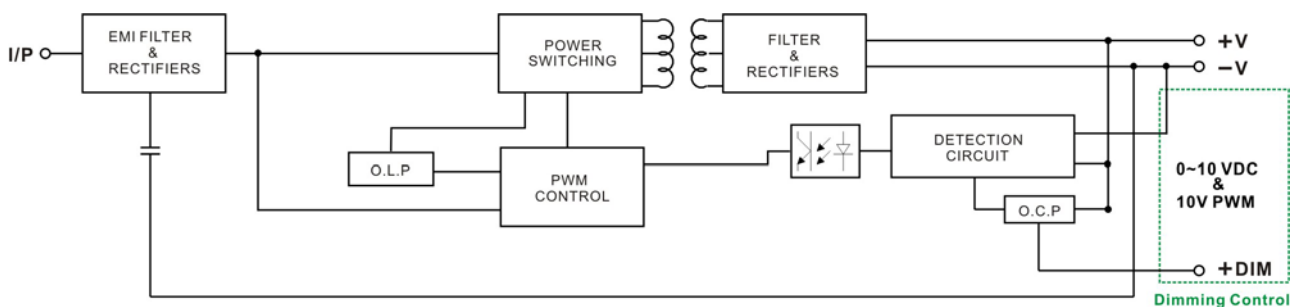
DERATING

BLOCK DIAGRAM

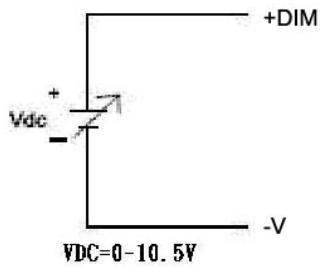
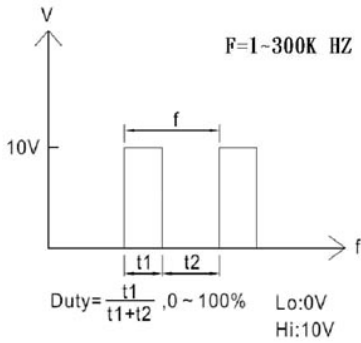
DIMMING CONTROL (CC Mode) (at 230VAC)

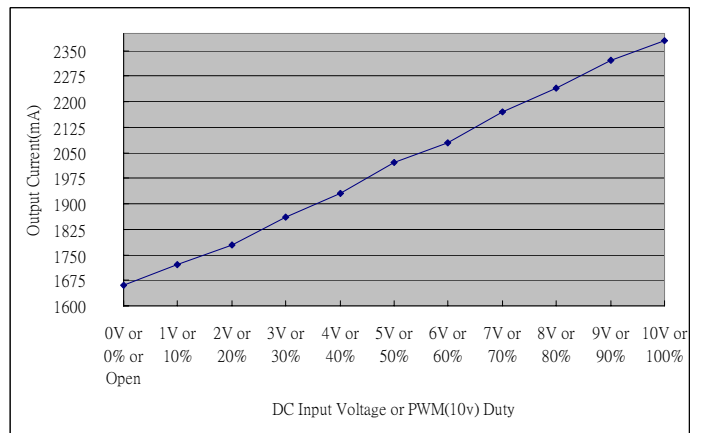

ZQF30-13.5



ZQF30-24S

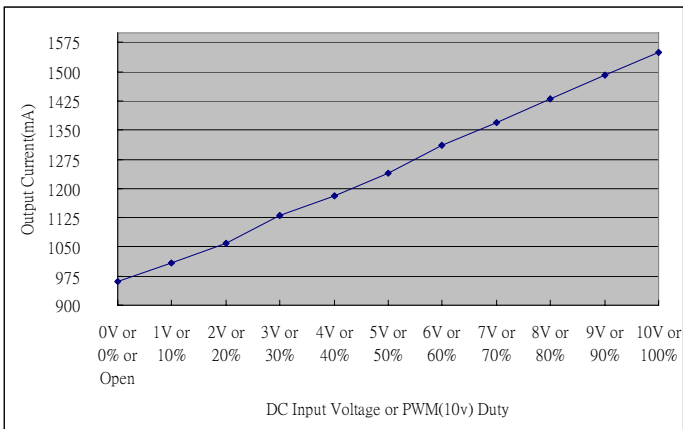

ZQF30-48S

