

*8A, 600V Ultrafast Single Diode*
**Features**

- Ultrafast recovery time  $t_r < 23\text{ns}$
- Low forward voltage drop
- Low leakage current
- High reliability by planer design
- Maximum Junction Temperature Range(150°C)

**General Description**

Winsemi's FRD.. series are the state of the are Ultra fast recovery rectifiers specifically designed with optimized performance of forward voltage drop and ultra fast recovery time The planar structure and the platinum doped life time control, guarantee the best overall performance, ruggedness and reliability characteristics.

**Applications**

- Freewheeling, Snubber, Clamp
- Inversion Welder
- PFC
- Plating Power Supply
- Ultrasonic Cleaner and Welder
- Converter & Chopper
- UPS

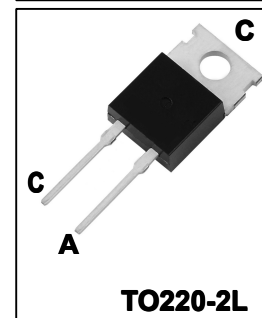
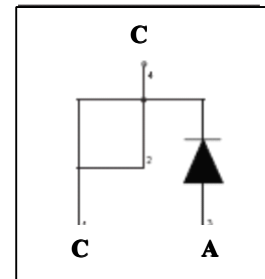
**Absolute Maximum Ratings**

Symbol	Parameter	Value	Units
$V_{RRM}$	Peak Repetitive Reverse Voltage	600	V
$I_{F(AV)}$	Average Forward Current Square wave, duty=1/2, $T_c=115^\circ\text{C}$	8	A
$I_{FM}$	Repetitive Peak Forward Current Square wave, 20kHz, $T_c=115^\circ\text{C}$	16	A
$I_{FSM}$	No-Repetitive Peak Surge Current	110	A
$P_D$	Power Dissipation	50	W
$T_{STG}, T_J$	Operating Junction Temperature & Storage Temperature	-40 to 150	$^\circ\text{C}$
Torque	Module-to-Sink , Recommended (M3)	1.1	N.m

**Electrical Characteristics** ( $T_c=25^\circ\text{C}$  unless otherwise noted)

Symbol	Parameter	Test Conditions	Value			Units
			Min	Typ	Max	
$V_F$	Forward Voltage Drop	$I_F=8\text{A}$	-	1.8	2.1	V
		$I_F=16\text{A}, T_c=125^\circ\text{C}$	-	1.4	-	V
$I_{RRM}$	Reverse Current	$V_R=600\text{V}$	-	-	15	$\mu\text{A}$
		$V_R=600\text{V}, T_c=125^\circ\text{C}$	-	-	250	$\mu\text{A}$
$t_r$	Reverse Recovery Time	$I_F=1.0\text{A}, V_R=30\text{V}, di_F/dt=50\text{A}/\mu\text{s}$	-	17	-	ns
		$I_F=8.0\text{A}, V_R=300\text{V}$ ,	-	30	-	ns
$R_{th(J-C)}$	Thermal Resistance		-	-	2.5	$^\circ\text{C}/\text{W}$

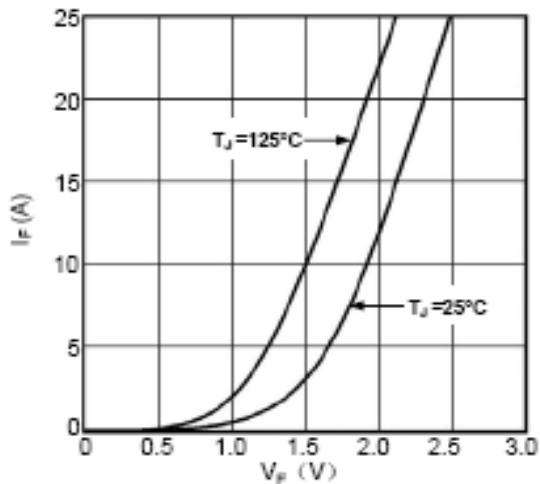

Fig1. Forward Voltage Drop vs Forward Current

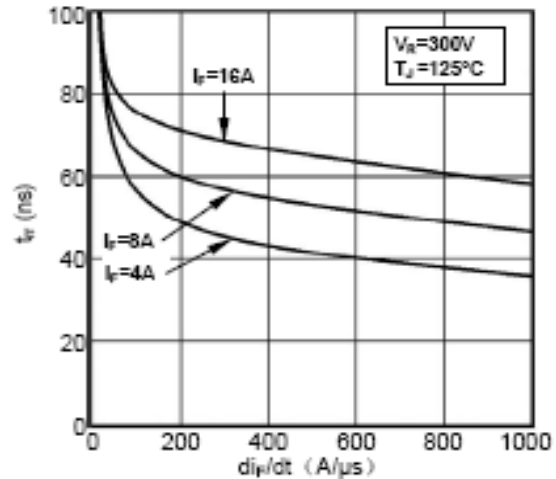

Fig2. Reverse Recovery Time vs  $di_V/dt$

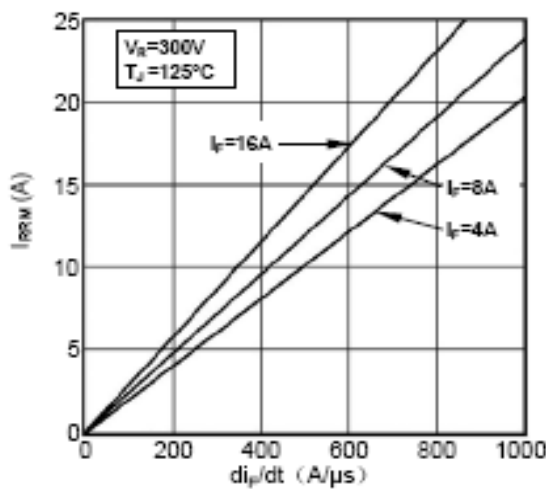

Fig3. Reverse Recovery Current vs  $di_V/dt$

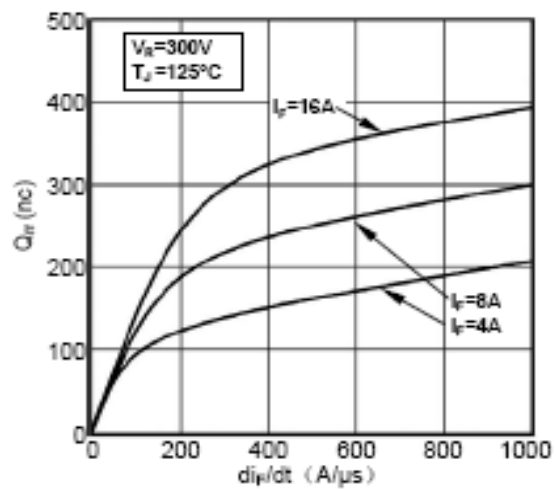

Fig4. Reverse Recovery Charge vs  $di_V/dt$

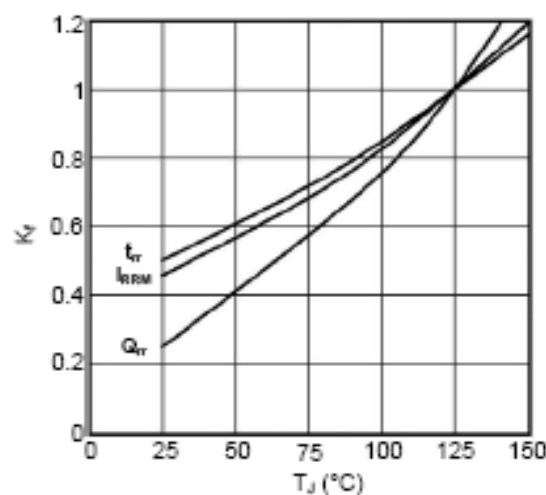

Fig5. Dynamic Parameters vs Junction Temperature

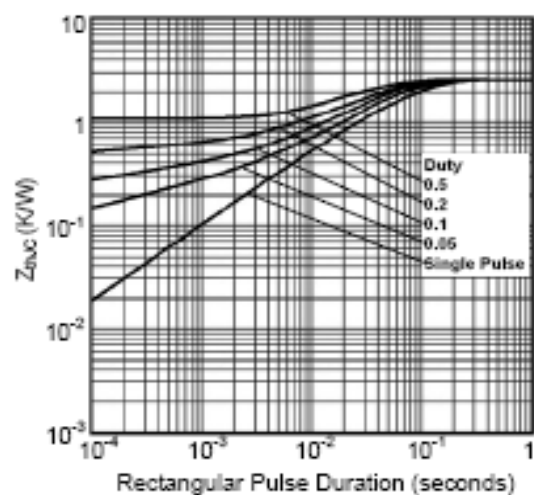
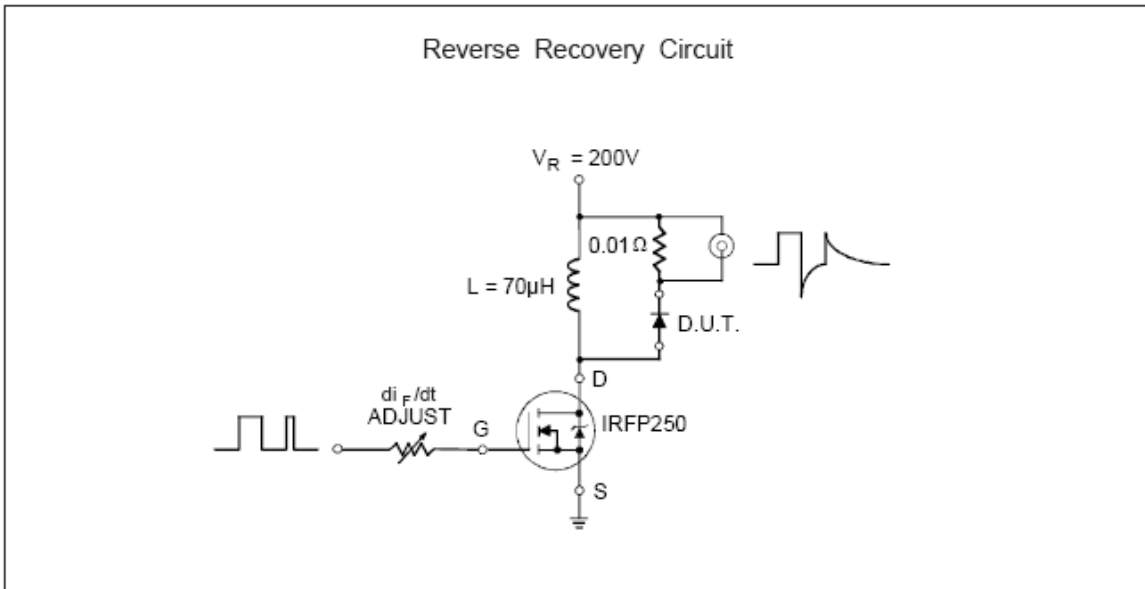
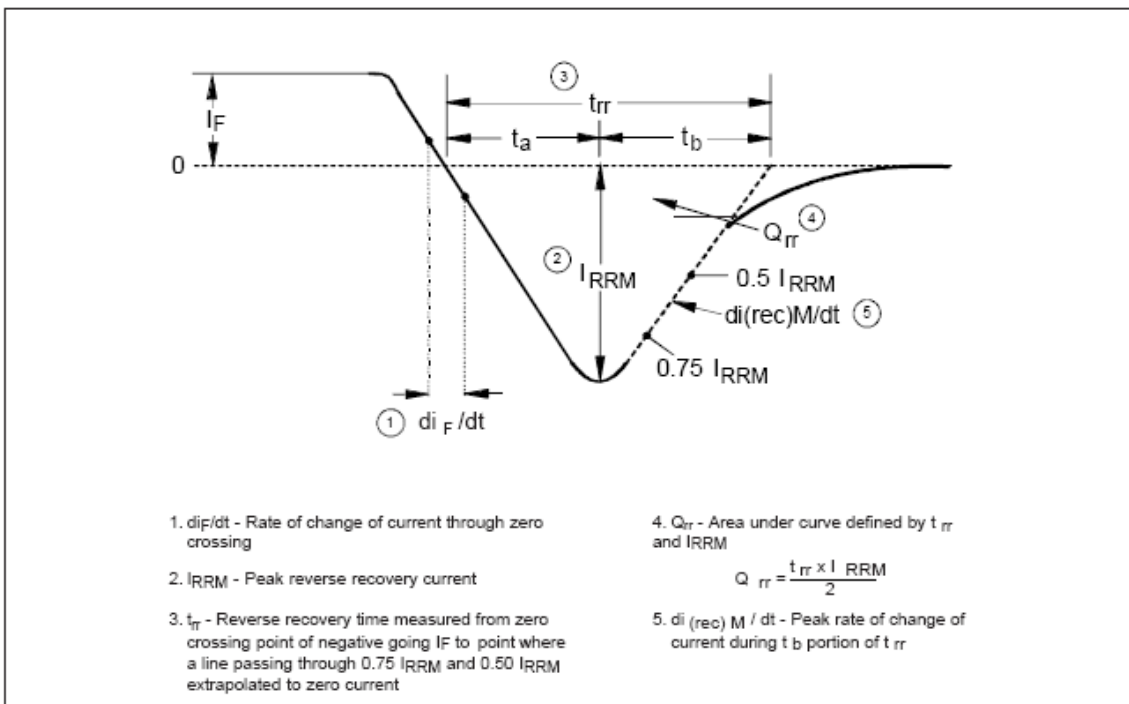

Fig6. Transient Thermal Impedance



**Fig.7 Reverse Recovery Parameter Test Circuit**



**Fig.8 Reverse Recovery Waveform and Definitions**

### TO220-2L Package Dimension

