

Switching (30V, ±11A)

RSS110N03

●Features

- 1) Low on-resistance.
- 2) Built-in G-S Protection Diode.
- 3) Small and Surface Mount Package (SOP8).

●Applications

Power switching, DC/DC converter.

●Structure

- Silicon N-channel MOS FET

●External dimensions (Units : mm)

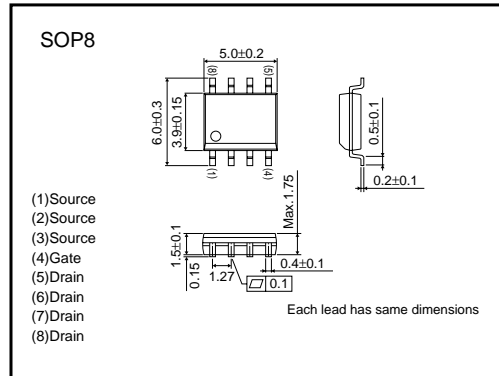

●Equivalent circuit

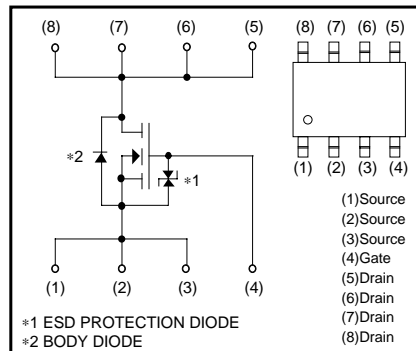

*A protection diode is included between the gate and the source terminals to protect the diode against static electricity when the product is in use. Use the protection circuit when the fixed voltages are exceeded.

●Absolute maximum ratings (Ta=25°C)

Parameter	Symbol	Limits	Unit
Drain-source voltage	V _{DSS}	30	V
Gate-source voltage	V _{GSS}	20	V
Drain current	Continuous	I _D	±11 A
	Pulsed	I _{DP}	±44 A *
Source current (Body diode)	Continuous	I _S	1.6 A
	Pulsed	I _{SP}	6.4 A *
Total power dissipatino (T _C =25°C)	P _D	2	W
Channel temperature	T _{ch}	150	°C
Strage temperature	T _{stg}	-55~+150	°C

*1 Pw≤10μs, Duty cycles≤1%

Transistor

●Thermal resistance (Ta=25°C)

Parameter	Symbol	Limits	Unit
Channel to ambient	Rth (ch-A)	62.5	°C / W

●Electrical characteristics (Ta=25°C)

Parameter	Symbol	Min.	Typ.	Max.	Unit	Conditions
Gate-source leakage	I _{GSS}	-	-	10	μA	V _{GS} =20V, V _{DS} =0V
Drain-source breakdown voltage	V _{(BR) DSS}	30	-	-	V	I _D =1mA, V _{GS} =0V
Zero gate voltage drain current	I _{BSS}	-	-	10	μA	V _{DS} =30V, V _{GS} =0V
Gate threshold voltage	V _{GS(th)}	1.0	-	2.5	V	V _{DS} =10V, I _D =1mA
Static drain-source on-starte resistance	R _{DS(on)}	-	7.6	10.4	mΩ	I _D =±11A, V _{GS} =10V
		-	10.3	14.3		I _D =±11A, V _{GS} =4.5V
		-	11.2	15.5		I _D =±11A, V _{GS} =4V
Forward transfer admittance	Y _{fs}	8.0	-	-	S	I _D =±11A, V _{DS} =10V
Input capacitance	C _{iss}	-	1300	-	pF	V _{DS} =10V
Output capacitance	C _{oss}	-	410	-	pF	V _{GS} =0V
Reverse transfer capacitance	C _{rss}	-	250	-	pF	f=1MHz
Turn-on delay time	t _{d(on)}	-	9	-	ns	I _D =5.5A, V _{DD} ≐15V
Rise time	t _r	-	17	-	ns	V _{GS} =10V
Turn-off delay time	t _{d(off)}	-	60	-	ns	R _L =2.73Ω
Fall time	t _f	-	30	-	ns	R _{GS} =10Ω
Total gate charge	Q _g	-	17	-	nC	V _{DD} ≐15V
Gate-source charge	Q _{gs}	-	3.3	-	nC	V _{GS} =5V
Gate-drain charge	Q _{gd}	-	7.1	-	nC	I _D =±11A

*Pulsed

●Body diode characteristics (Source-Drain Characteristics) (Ta=25°C)

Parameter	Symbol	Min.	Typ.	Max.	Unit	Conditions
Forward voltage	V _{SD}	-	-	1.2	V	I _S =6.4A, V _{GS} =0V

*Pulsed

●Electrical characteristic curves

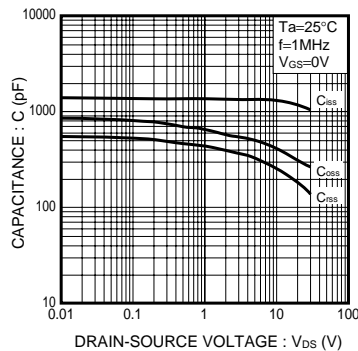

Fig.1 Typical Capacitance vs. Drain-Source Voltage

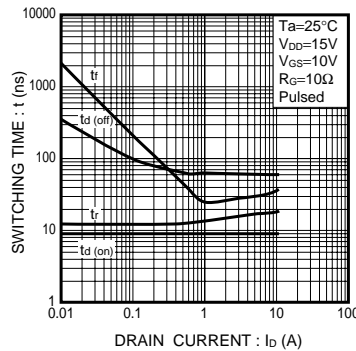

Fig.2 Switching Characteristics

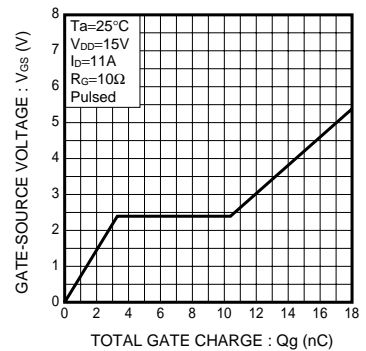

Fig.3 Dynamic Input Characteristics

Transistor

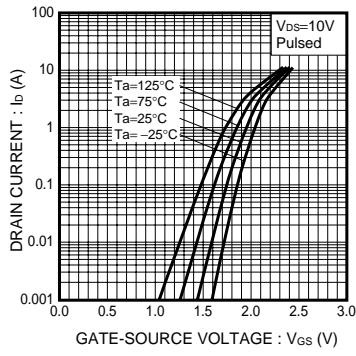

Fig.4 Typical Transfer Characteristics

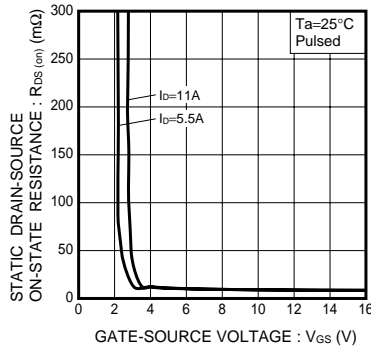

Fig.5 Static Drain-Source On-State Resistance vs. Gate-Source Voltage

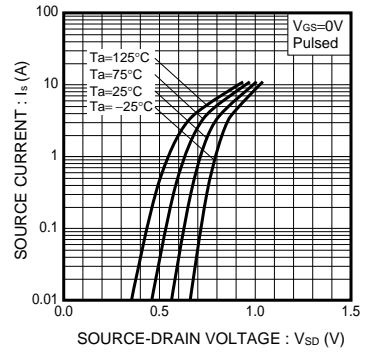

Fig.6 Source Current vs. Source-Drain Voltage

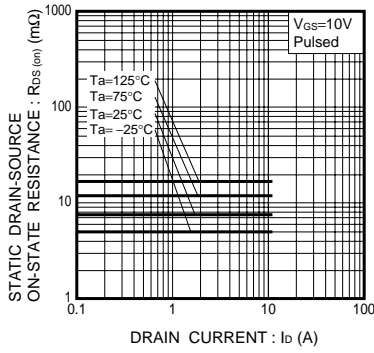

Fig.7 Static Drain-Source On-State Resistance vs. Drain Current (I)

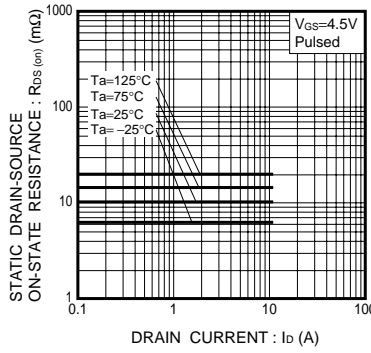

Fig.8 Static Drain-Source On-State Resistance vs. Drain Current (II)

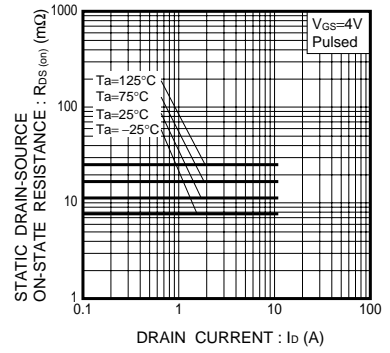

Fig.9 Static Drain-Source On-State Resistance vs. Drain Current (III)