

Glossary of terms

plug a connector for fitting to the free end of a coaxial cable and incorporating the coupling nut, ring or sleeve. With the exception of certain sub-miniature connectors, it has a male centre contact.

jack a connector for fitting to the free end of a coaxial cable, suitable for mating with the appropriate plug. It generally has a female centre contact.

socket a connector for panel or bulkhead mounting, suitable for mating with the appropriate plug and having a solder spill for attachment of equipment wire. With the exception of certain sub-miniature connectors, it has a female centre contact.

panel socket a socket with a square or lozenge-shaped flange, drilled or tapped with 2 or 4 holes for fixing to the panel.

bulkhead socket a socket designed for single hole fixing in the panel or bulkhead, retained by a single fixing nut and lockwasher.

panel jack a jack which accepts coaxial cable and which is suitable for panel mounting with 2 or 4 fixing holes.

bulkhead jack a jack which accepts coaxial cable and which is suitable for single-hole fixing in the panel or bulkhead.

elbow a right angled connector. It has a 90° angle between the mating face and cable entry or PCB.

m or **f** a suffix indicating the gender of a centre contact: **m** for male, **f** for female (note: the IEC specifications apply the term 'socket' to items designated "jack" and "socket" above). The separate terms are retained in this catalogue for consistency with earlier publications and for clarity.

captive contact a centre contact positively positioned and retained in the assembled connector (see non-captive contact).

non-captive contact a centre contact whose position and retention are achieved by the assembly of the connector to cable or other circuitry.

coaxial launcher a connector designed to facilitate an impedance matched transition from coax to microwave systems, eg strip line, microstrip, waveguide etc.

stub contact a centre contact having a plain cylindrical rear portion (sometimes of a smaller diameter) for joining to circuits.

tab contact a centre contact having a thin rectangular tab for joining to circuits.

slotted contact a centre contact with a cylindrical rear portion having an axial slot for joining to circuits.

semi-slotted contact a cylindrical contact cut-away to provide a 'D' sectioned end for joining to circuits.

surface launch description of connector for stripline use in which the connector axis is at right angles to the plane of signal propagation.

termination an rf component acting as a dummy load at the free end of a cable or circuit.

Part number system

Greenpar connector part numbers can only be assigned at the factory, however to assist in product identification solely from the part number the following guidelines may be used.

Typical part number

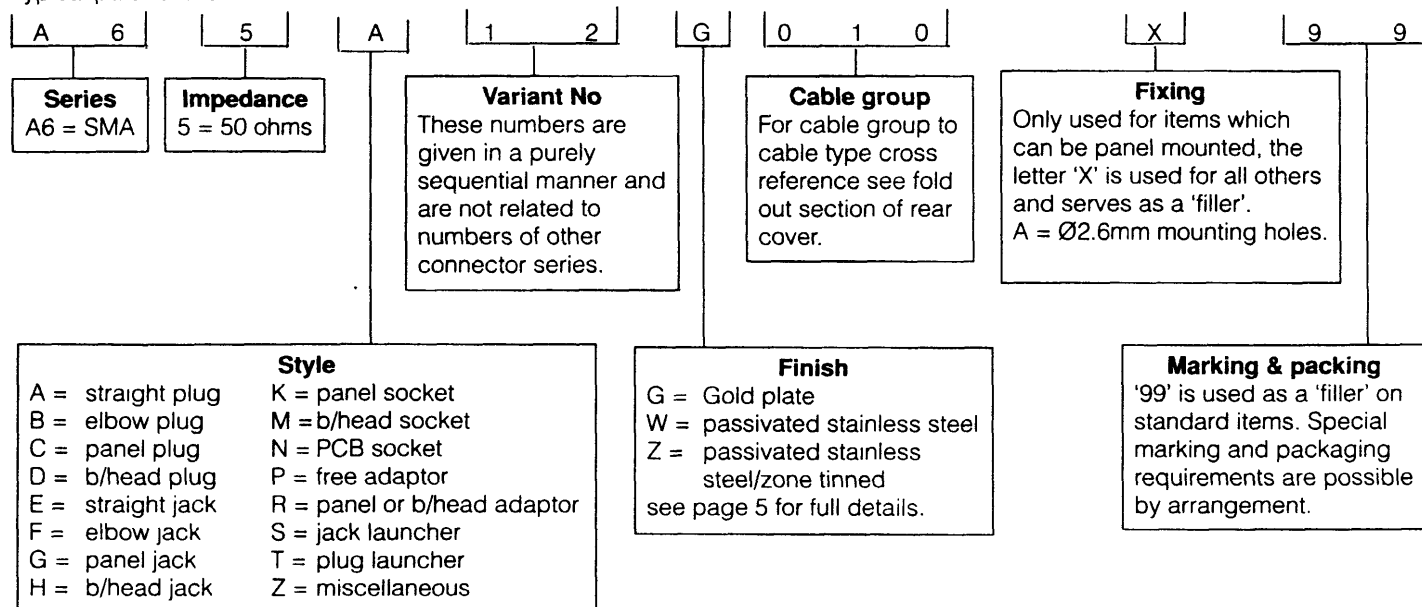

Product description/QA and approvals/materials and finishes

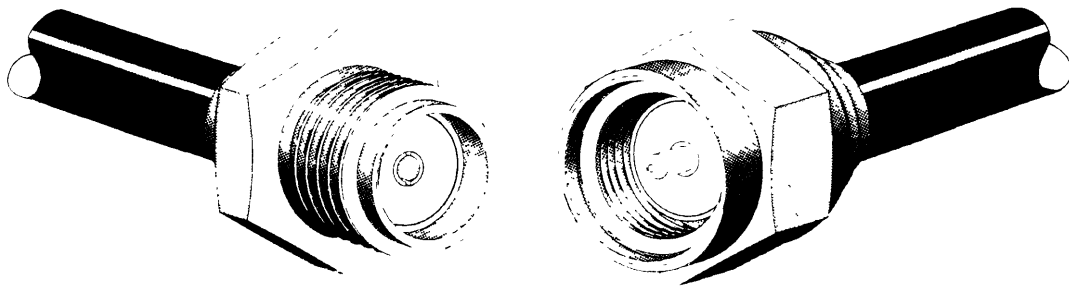

Product Description

Greenpar SMA connectors have been designed for critical performance and miniaturization requirements. They are recommended for test equipment, video, IF, and RF systems as well as EW, radar guidance and wideband high frequency application. Although optimum performance is achieved by using SMA connectors with .141 inch semi rigid cable, a range of connectors for .085 and .047 inch semi rigid cables and various flexible cables is available. In addition transition from co-axial line to equipment or impedance matched transition to various circuit boards and MIC is catered for by an extensive range of sockets and co-axial launchers.

Quality Assurance and Approvals

Greenpar places great emphasis on tight quality control of all aspects of manufacture, using both in-process control and statistical sampling as appropriate. Capability studies, statistical process control, surface finish, plating thickness using x-ray fluorescence, chemical analysis using traditional and atomic absorption techniques, environmental testing, vector network analysis — these and more are part of our everyday activities in assuring a quality product. Quality activities extend beyond the manufacturing area to embrace the wider company operations needed to support DEF-STAN 05-21 and BS 9000 approvals (the latter having the same status as BS 5750). The company systems as defined in our Quality Manual have been accepted by CAA, BT and many other major companies. Greenpar has held BS 9000 product approvals since 1981 and will shortly be offering CECC approvals on a range of products.

Materials

Standard connectors are constructed as follows -

Centre contacts (male and female)	Beryllium copper
Body, Shell Parts, Nuts, Cable Clamping Parts	Stainless Steel
Dielectric	Solid TFE
	Fluorocarbon
Lock washers	Stainless steel
Crimp sleeves	Brass
Gaskets	Silicone rubber

Special variants such as BeCu or Brass bodies may be available on request

Finishes

All centre contacts are plated 2 5/3.0µm gold over 2.0µm copper. Body shell parts, nuts and cable clamping parts are either -

Gold	Finish code G
Passivated	Finish code W
Passivated/Zone	
Tinned*	Finish code Z
Lock washers	Gold ('G' finish connector)
	Passivated ('W' and 'Z' finish connector)
Crimp sleeve	Gold ('G' finish connector)
	Nickel ('W' finish connector)

* Typical 'Z' finish connector body

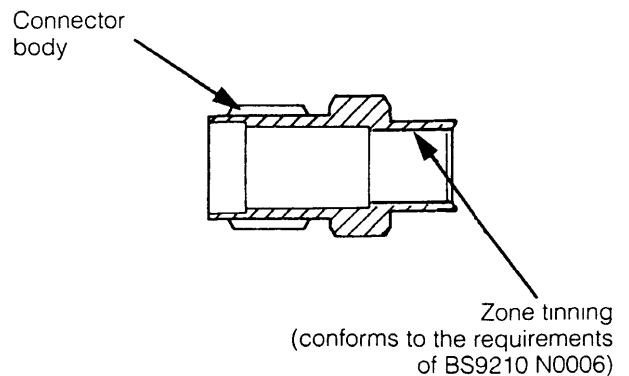

Typical piece parts and methods of cable retention

Flexible cables

Clamp attachment body

Crimp attachment body

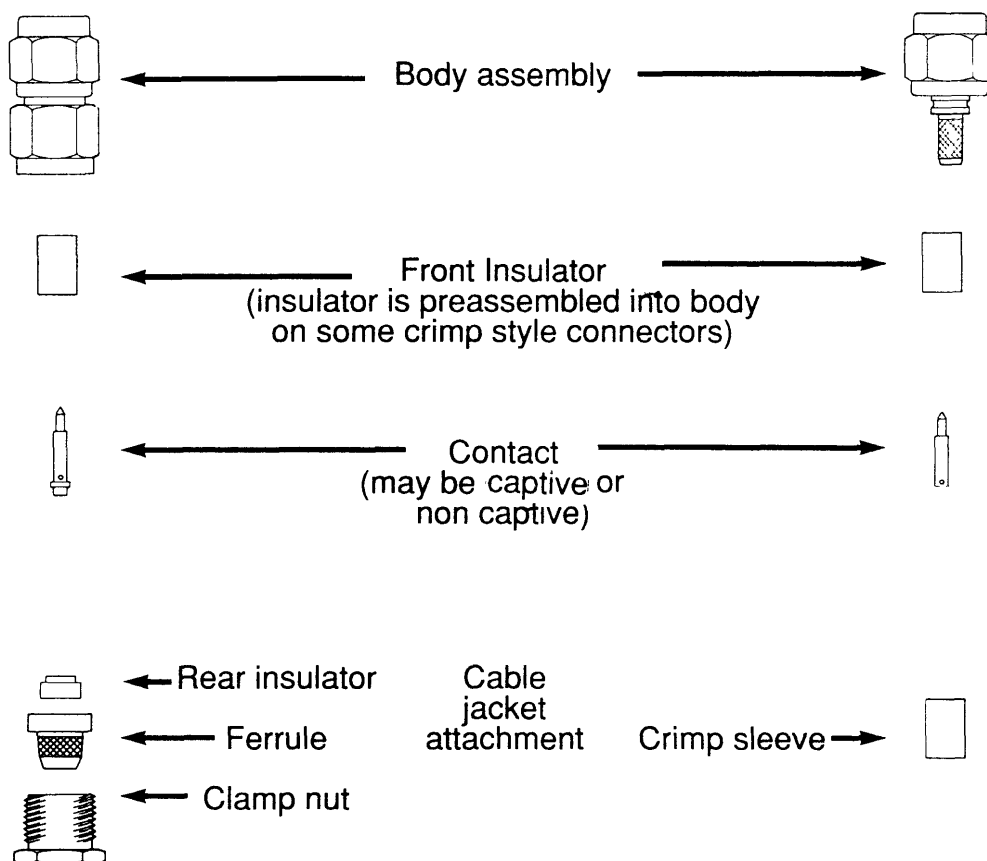

The clamp method of fastening connectors to co-axial cable requires mechanical clamping of the braid, usually by means of a threaded nut, and soldering of the centre conductor to the contact. In some cases the braid of flexible cable can be soldered directly to the connector ferrule.

The main advantage of the clamp/solder termination is its independence from special tools — only common workshop tools are needed. It also has the advantage that the joint can be inspected and if necessary, be re-made with or without shortening the cable. This method is recommended where successive cable trimming is necessary, e.g. phase trimming.

A crimped connector comprises only a few piece parts and produces a fast, consistent and reliable result at a low applied cost.

The braid is secured by being trapped between a crimped metal sleeve and the body of the connector. (Alternatively the braid may be soldered to the body inside the sleeve if no crimp tool is available). In many cases crimping provides a greater 'pull-off' resistance than the equivalent clamp.

Greenpar crimp SMA connectors have a solder centre contact and a crimp sleeve for the braid.

Part numbers for Greenpar crimping tools are on page 32.

Typical piece parts and methods of cable retention

Semi rigid cables

Solder attachment
body

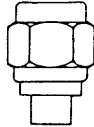

← Body assembly



← Insulator
(assembled from front on
solder style connectors.)



← Contact

The solder method of attaching connectors to co-axial semi rigid cable produces superior electrical and mechanical results. Although originally designed for optimum performance with .141 inch semi-rigid cable, the solder attachment method will in addition give excellent all round performance when used with .085 inch and other smaller semi-rigid cables.

Cable assemblies

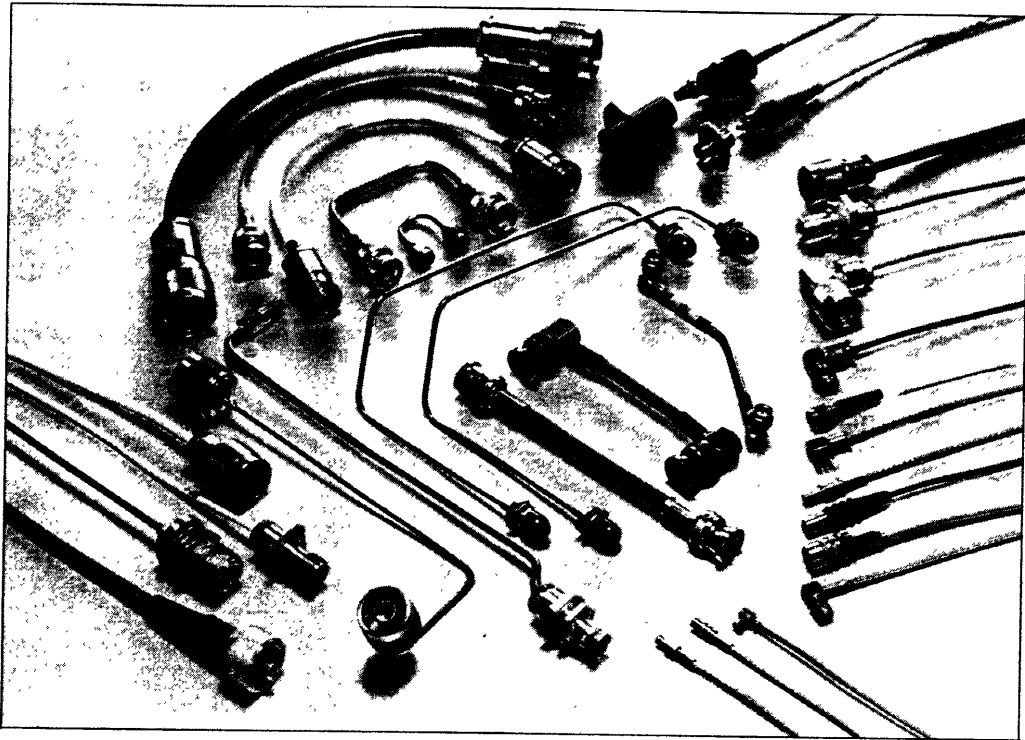

In today's high performance R.F. and microwave systems, precision coaxial cable assemblies play a major role. Electrical performance and mechanical integrity are therefore of critical importance.

To achieve consistent high quality results investment is necessary not only in tooling and advanced test equipment but in operator skill and approved quality assurance procedures — Greenpar has made such an investment.

Greenpar's cable assembly experience goes back over 25 years and ranges from high power braided cables through to today's high frequency micro-miniature semi-rigid types with diameters of 0.085 inch, 0.047 inch and smaller.

For flexible cable assemblies we will require details of cable type, overall length, connector part numbers and special markings. For semi rigid assemblies, full mechanical and electrical specification is required.

For all custom cable assemblies dimensions should be given to the connector reference plane.

Semi rigid cables, most commonly used with SMA connectors, are precisely formed using a PIA BENDMASTER cable former and dimensional checking is performed on an APRICOT PC/Xi controlled KEMCO 600 3 co-ordinate measurement system. Temperature cycling to relax the teflon dielectric is carried out after forming and prior to connector attachment as standard on every cable. Electrical specification options include specified VSWR, attenuation, electrical length (delay) and matching options for pairs or sets. All precision cable assemblies are fully tested using an H.P. 8510B to ensure Quality and Reliability in a product ready for connection.

Greenpar's investment in tooling and test equipment is complemented by thorough operator training and experience resulting in a highly skilled team that produce a product that meets your requirements.

Electrical and mechanical specification

Greenpar SMA connectors have been designed to meet or exceed the requirements of BS 9210 N0006 and MIL-C-39012.

	BS 9210 N0006	MIL-C-39012
VSWR (straight semi-rigid styles) 2GHz to 18GHz	1.07 + 0.01f*	1.07 + 0.01f*
VSWR (straight flexible cable styles) 2GHz to 12.4GHz #	1.20 + 0.03f*	1.20 + 0.03f*
VSWR (elbows, semi-rigid styles) 2GHz to 18GHz	1.10 + 0.01f*	1.10 + 0.01f*
VSWR (elbows, flexible cable styles) 2GHz to 12.4GHz #	1.20 + 0.03f*	1.20 + 0.03f*
VSWR (straight adaptors) 2GHz to 18GHz	1.1 + 0.01f*	
VSWR (elbow adaptors) 2GHz to 18GHz	1.2 + 0.03f*	
Capacitance max. (solder bucket style)	5pF	N/A
RF shunt resistance (solder bucket style)	1 MΩ @ 30MHz	N/A
Working Voltage # (dc or ac peak) at sea level	450V	500V
at altitude of 20 km. (44m bars)	60V	125V
Proof Voltage # at sea level	1400V	1500V
at altitude of 20km (44m bars)	180V	375V
Contact resistance (max) before conditioning	3.0 mΩ	3.0 mΩ
after conditioning	8.0 mΩ	4.0 mΩ
Outer conductor continuity before conditioning	2.0 mΩ	2.0 mΩ
after conditioning	7.0 mΩ	N/A
Insulation resistance before conditioning	5 GΩ	5 GΩ
after conditioning	200 MΩ	N/A
Vibration severity frequency range	10 Hz — 2 kHz	MIL STD 202
displacement	0.75mm	method 204 (D)
acceleration	98m/s ²	
duration	6 hours	
Shock severity	490 m/s ² for 11ms	MIL STD 202 method 213 (1)
Bump severity	4000 @ 390 m/s ²	N/A
Climatic category (general) semi-rigid styles	55/155/21 55/105/21	MIL STD 202 method 101 (B)
Impact severity	5 impacts @ 1 m	N/A
Engagement/separation torque	250mN.m max.	226mN.m max
Normal coupling torque	800 — 1100mN.m	N/A
Proof coupling torque	1650 mN.m	1695 mN m
Material	N/A	All materials to relevant federal specifications
Finish	To meet climatic category 55/155/21	To paragraph 3.14 of specification
Design	To control drawings part 2 Figs. 1 & 2	Within interface dimensions of spec

Notes

* f is frequency in GHz
dependent on cable used.

Interface Dimensions

Greenpar's SMA connectors are intermateable with all connectors meeting the interface dimensions of BS9210 N0006 and MIL-C-39012 series SMA.

For styles qualified to BS9210 see qualification cross reference.

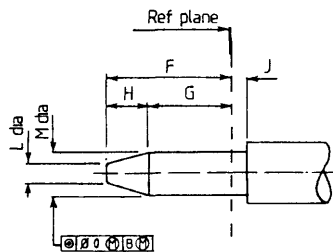

Ref letter	Plug dimensions	minimum	nominal	maximum
A dia		6.48		
B dia				4.59
C				3.43
D		2.54		
E		0.38		1.14
F				2.54
G		1.27		
H		0.38		
J		0.00		
K				0.05
L dia				0.38
M dia		0.899		0.94
N				0.08x45°
P dia		4.12		
Q		2.01		

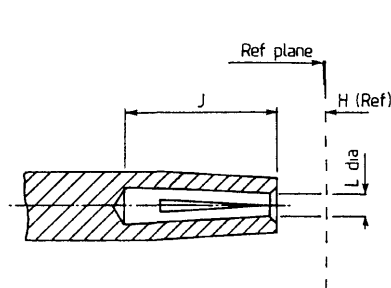
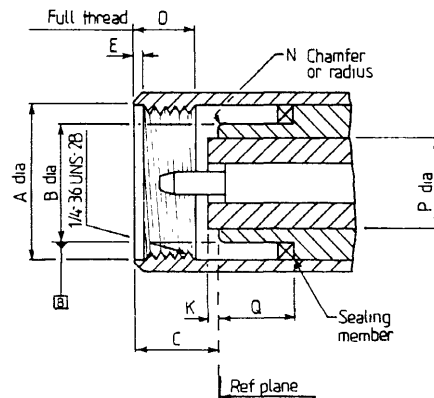

Ref letter	Jack dimensions.	minimum	nominal	maximum
A dia		5.28		5.49
B dia		4.60		
C		3.56		
D		4.32		
E		0.38		1.14
F		1.88		1.98
G				0.05
H		0.00		0.38
J		2.92		
K				0.13x45°
L dia			*	
M dia			4.12	
N dia		4.27		

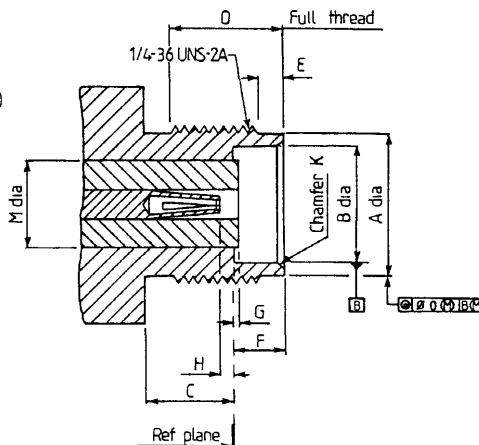

* Diameter L and closure shall meet performance requirements of BS 9210 N0006

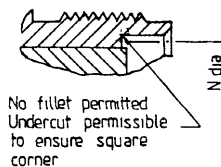

Typical VSWR and insertion loss characteristics

Typical VSWR/Insertion loss plot for SMA mated pair on RG 402 (0.141")

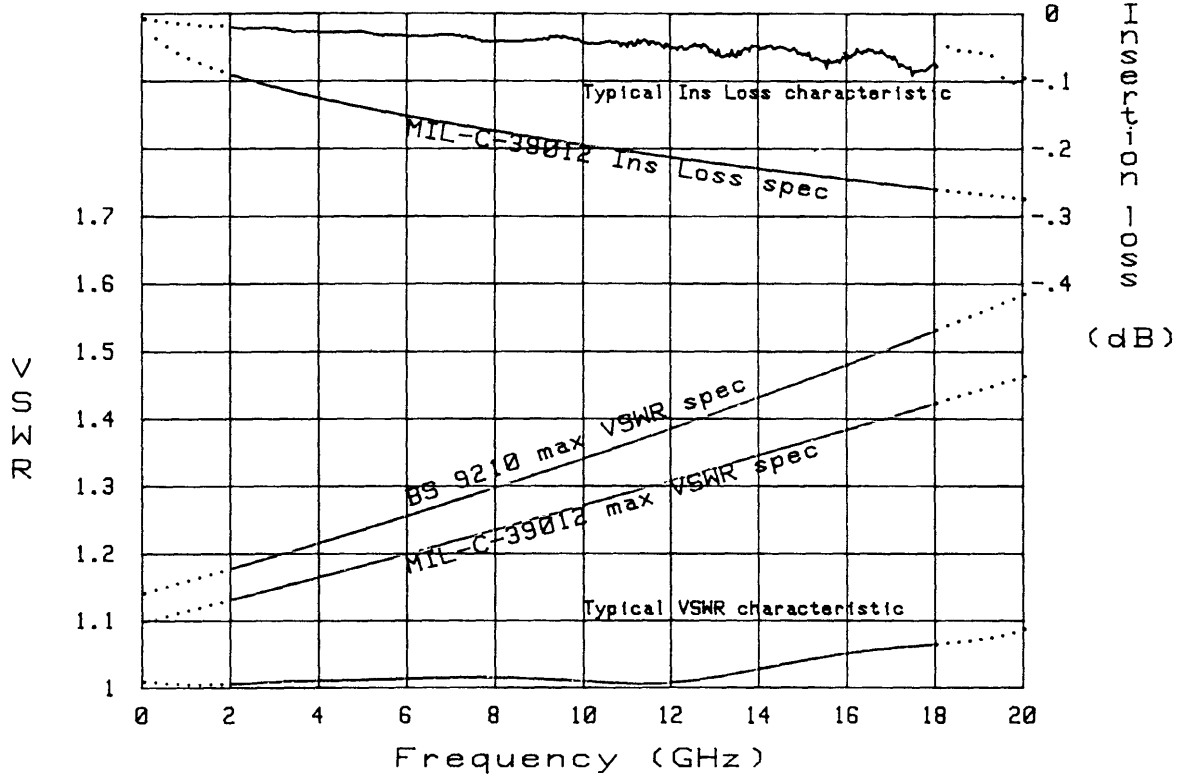

Typical VSWR/Insertion loss plot for SMA mated pair on RG 405 (0.085")

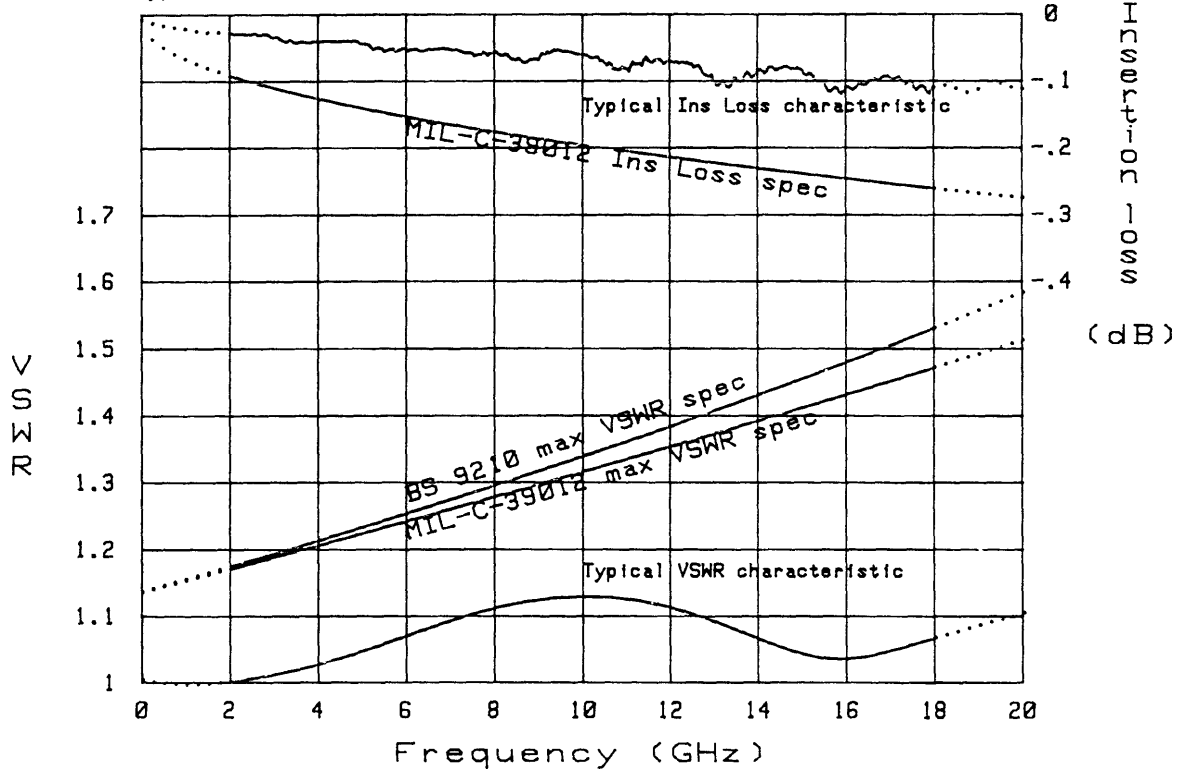

Plugs for semi-rigid cables

Straight plug (low profile)
without centre contact
solder attachment body
thin walled

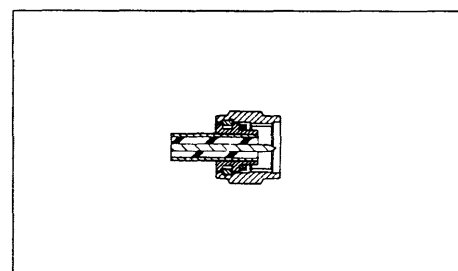
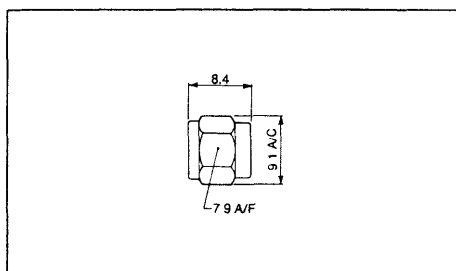

* Cable Group	Body Finish
073	Gold
073	Passivated/zone tinned

Part Number
A65A04G073X99 } A65A04Z073X99 }

Cable centre conductor suitably pointed is used as connector centre contact

Assembly Instr Page
35(b) 35(b)

Straight plug (low profile)
without centre contact
solder attachment body
thick walled

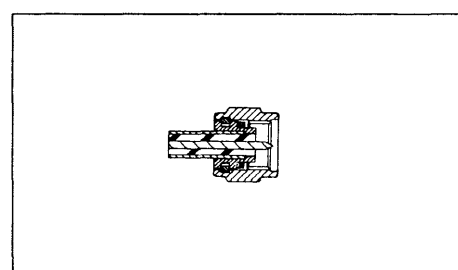
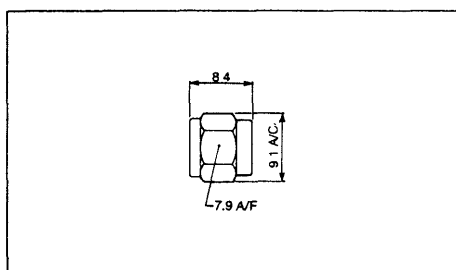

* Cable Group	Body Finish
073	Gold
073	Passivated/zone tinned

Part Number
A65A13G073X99 } A65A13Z073X99 }

Cable centre conductor suitably pointed is used as connector centre contact

Assembly Instr Page
36(a) 36(a)

Straight plug
without centre contact
solder attachment body
thin walled

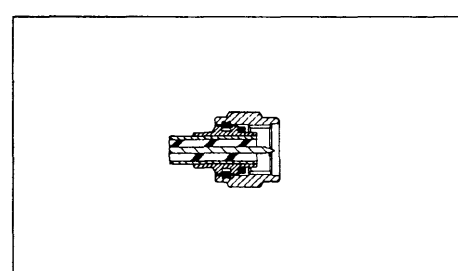
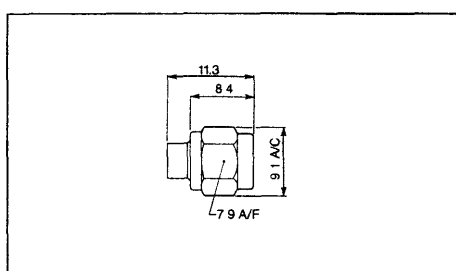

* Cable Group	Body Finish
073	Gold
073	Passivated/zone tinned

Part Number
A65A11G073X99 } A65A11Z073X99 }

Cable centre conductor suitably pointed is used as connector centre contact

Assembly Instr Page
35(b) 35(b)

* For cable group to cable type cross reference see fold out section of rear cover
Preferred part numbers.

For materials and finishes see page 5

All dimensions are nominal

For styles qualified to BS9210 see qualification cross reference

Plugs for semi-rigid cables

Straight plug
Solder centre contact
(non captive)
solder attachment body

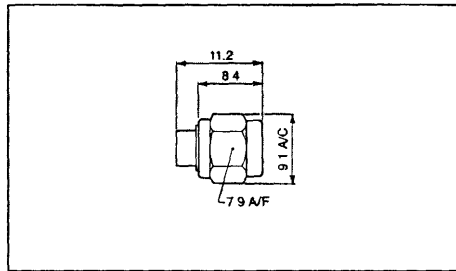

* Cable Group	Body Finish	Part Number	Assembly Instr Page
073	Gold	A65A07G073X99	35(a)
073	Passivated/zone tinned	A65A07Z073X99	35(a)
285	Gold	Z65A07G285X99	35(a)
285	Passivated/zone tinned	A65A07Z285X99	35(a)

Elbow plug
solder centre contact
(captive)
solder attachment body

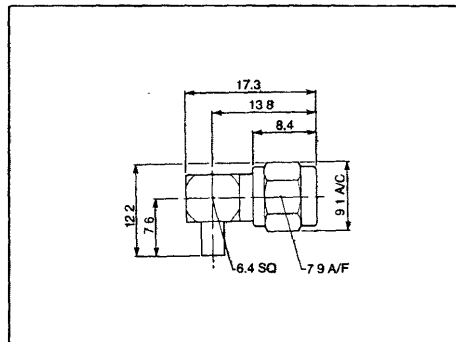

* Cable Group	Body Finish	Part Number	Assembly Instr Page
073	Gold	A65B02G073X99	36(b) 36(b) 36(b) 36(b)
073	Passivated/zone tinned	A65B02Z073X99	
285	Gold	A65B02G285X99	
285	Passivated/zone tinned	A65B02Z285X99	

DC to 12.4GHz

* For cable group to cable type cross reference see fold out section of rear cover.
Preferred part numbers

For materials and finishes see page 5

All dimensions are nominal.

For styles qualified to BS9210 see qualification cross reference

Plugs for flexible cables

Straight plug
solder centre contact
(captive)
clamp attachment body

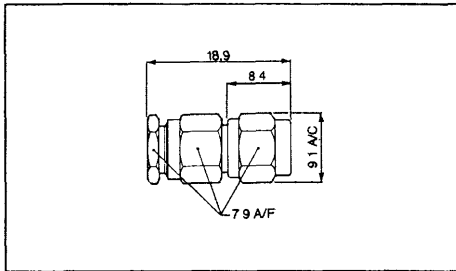

* Cable Group	Body Finish	Part Number	Assembly Instr Page
010	Gold	A65A61G010X99	39(a)
010	Passivated	A65A61W010X99	39(a)
022	Gold	A65A61G022X99	39(a)
022	Passivated	A65A61W022X99	39(a)
024	Gold	A65A61G024X99	39(a)
024	Passivated	A65A61W024X99	39(a)
060	Gold	A65A61G060X99	39(a)
060	Passivated	A65A61W060X99	39(a)

Elbow plug
solder centre contact
(captive)
clamp attachment body

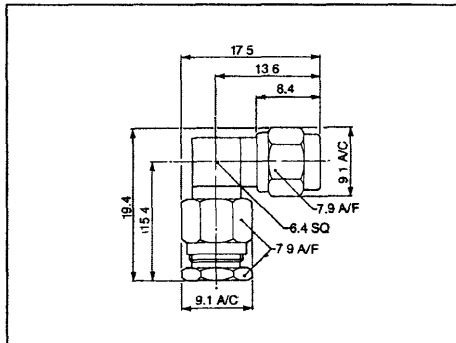

* Cable Group	Body Finish	Part Number	Assembly Instr Page
010	Gold	A65B62G010X99	39(b)
010	Passivated	A65B62W010X99	39(b)
022	Gold	A65B62G022X99	39(b)
022	Passivated	A65B62W022X99	39(b)
024	Gold	A65B62G024X99	39(b)
024	Passivated	A65B62W024X99	39(b)
060	Gold	A65B62G060X99	39(b)
060	Passivated	A65B62W060X99	39(b)

} DC to 12.4GHz

* For cable group to cable type cross reference see fold out section of rear cover.
Preferred part numbers.

For materials and finishes see page 5.

All dimensions are nominal

For styles qualified to BS9210 see qualification cross reference.

Plugs for flexible cables

Straight plug
solder centre contact
(non captive)
crimp attachment body

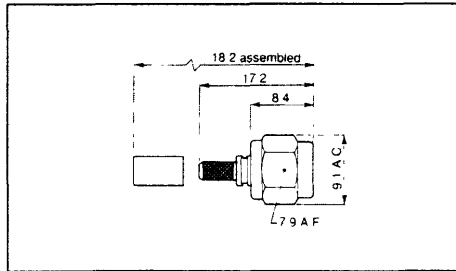

Cable Group	Body Finish	Part Number	Assembly Instr	Page
010	Gold	A65A41G010X99		37(b)
010	Passivated	A65A41W010X99		37(b)
022	Gold	A65A41G022X99		37(b)
022	Passivated	A65A41W022X99		37(b)
060	Gold	A65A41G060X99		37(b)
060	Passivated	A65A41W060X99		37(b)
429	Gold	A65A41G429X99		37(b)
429	Passivated	A65A41W429X99		37(b)

Straight plug
solder centre contact
(captive)
crimp attachment body

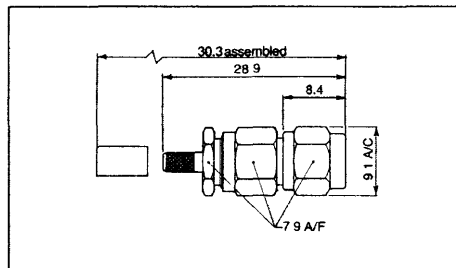

* Cable Group	Body Finish	Part Number	Assembly Instr	Page
010	Gold	A65A21G010X99		38(b)
010	Passivated	A65A21W010X99		38(b)
022	Gold	A65A21G022X99		38(b)
022	Passivated	A65A21W022X99		38(b)
024	Gold	A65A21G024X99		38(b)
024	Passivated	A65A21W024X99		38(b)
060	Gold	A65A21G060X99		38(b)
060	Passivated	A65A21W060X99		38(b)
429	Gold	A65A21G429X99		38(b)
429	Passivated	A65A21W429X99		38(b)

* For cable group to cable type cross reference see fold out section of rear cover
Preferred part numbers

For materials and finishes see page 5

All dimensions are nominal

For styles qualified to BS9210 see qualification cross reference

Plus for flexible cables

Elbow plug
Solder centre contact
(captive)
crimp attachment body

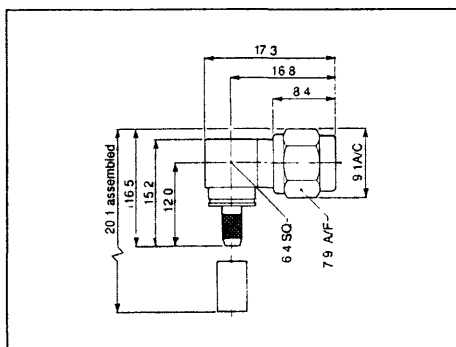

* Cable Group	Body Finish	Part Number	Assembly Instr Page
010	Gold	A65B42G010X99	38(a)
010	Passivated	A65B42W010X99	38(a)
022	Gold	A65B42G022X99	38(a)
022	Passivated	A65B42W022X99	38(a)
024	Gold	A65B42G024X99	38(a)
024	Passivated	A65B42W024X99	38(a)
060	Gold	A65B42G060X99	38(a)
060	Passivated	A65B42W060X99	38(a)
429	Gold	A65B42G429X99	38(a)
429	Passivated	A65B42W429X99	38(a)

DC to 12.4GHz

Straight plug
solder centre contact
(non captive)
solder attachment body

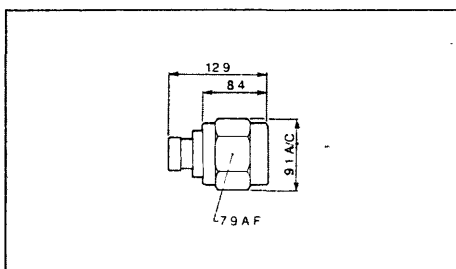

* Cable Group	Body Finish	Part Number	Assembly Instr Page
425	Gold	A65A03G425X99	40(b)
425	Passivated/zone tinned	A65A03Z425X99	40(b)
426	Gold	A65A03G426X99	40(b)
426	Passivated/zone tinned	A65A03Z426X99	40(b)

* For cable group to cable type cross reference see fold out section of rear cover.
Preferred part numbers

For materials and finishes see page 5

All dimensions are nominal

For styles qualified to BS9210 see qualification cross reference

Jacks for semi-rigid cables

Jack
solder centre contact
(non captive)
solder attachment body

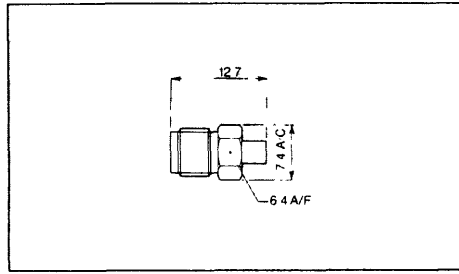

* Cable Group	Body Finish
073	Gold
073	Passivated/zone tinned
285	Gold
285	Passivated/zone tinned

Part Number
A65E06G073X99
A65E06Z073X99
A65E06G285X99
A65E06Z285X99

Assembly Instr	Page
35(a)	35(a)
35(a)	35(a)
35(a)	35(a)
35(a)	35(a)

Panel Jack
solder centre contact
(non captive)
solder attachment body

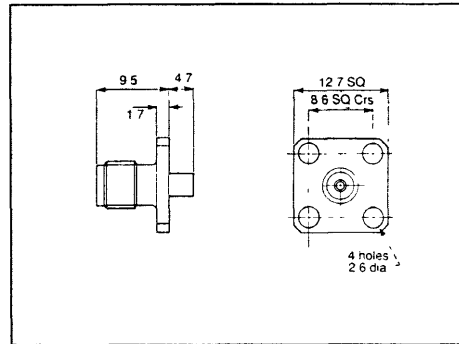

mounting details

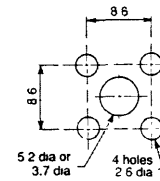

* Cable Group	Body Finish
073	Gold
073	Passivated/zone tinned
285	Gold
285	Passivated/zone tinned
430	Gold
430	Passivated/zone tinned

Part Number
A65G03G073A99
A65G03Z073A99
A65G03G285A99
A65G03Z285A99
A65G01G430A99
A65G01Z430A99

insulator pre-assembled

Assembly Instr	Page
35(a)	35(a)
35(a)	35(a)
35(a)	35(a)
35(a)	35(a)
37(a)	37(a)
37(a)	37(a)

Panel Jack
solder centre contact
(non captive)
solder attachment body

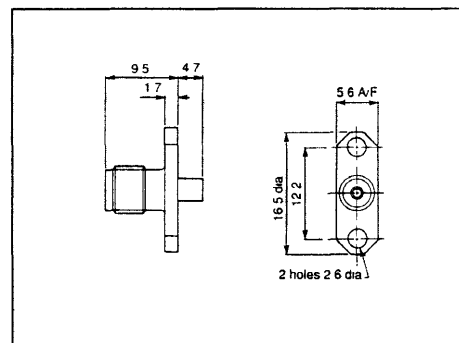

mounting details

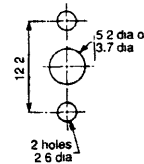

* Cable Group	Body Finish
073	Gold
073	Passivated/zone tinned
285	Gold
285	Passivated/zone tinned

Part Number
A65G17G073A99
A65G17Z073A99
A65G17G285A99
A65G17Z285A99

Assembly Instr	Page
35(a)	35(a)
35(a)	35(a)
35(a)	35(a)
35(a)	35(a)

* For cable group to cable type cross reference see fold out section of rear cover.
Preferred part numbers.

For materials and finishes see page 5.
All dimensional.
For styles qualified to BS9210 see qualification cross reference.

Assembly instructions

Instruction (a)

- 1** Clean outer conductor. Trim back outer conductor and dielectric to dimension shown. Do not nick centre conductor.

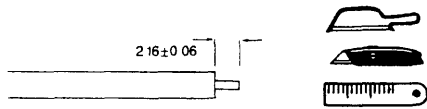

- 2** Solder contact to centre conductor, allow gap 'A' shown in the table below by using a shim or spacer.

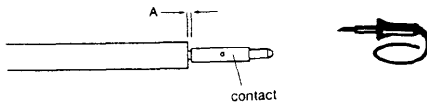

- 3** The above operation is easier if the contact holding tool is used with the cable clamped in an appropriate assembly kit.

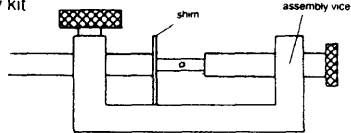

- 4** Screw body onto mating face setting tool and assemble onto cable.

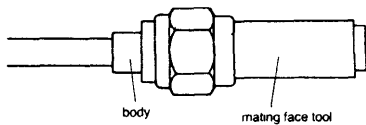

- 5** Clamp into assembly kit vice. Ensure contact locates fully in mating face setting tool and soft solder body to outer conductor.

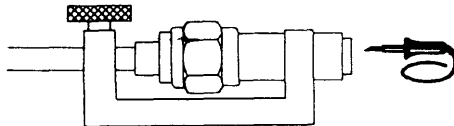

- 6** Remove assembly from assembly kit vice and unscrew mating face tool. Using trimming tool, trim expanded dielectric from base of bore.

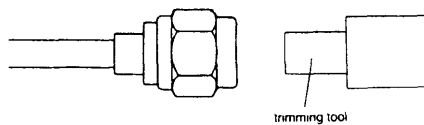

- 7** Insert Insulator

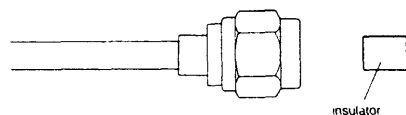

Cable Group	Dimensions A
73	0.25 ± 0.05 (0.010")
285	0.38 ± 0.05 (0.015")

[SMA 001]

Instruction (b)

- 1** Clean outer conductor. Trim back outer conductor to dimension shown.

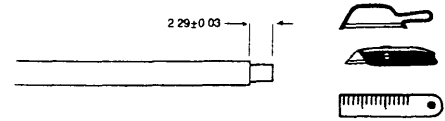

- 2** Insert body until mating face is flush with outer sheath. Soft solder cable outer conductor to body.

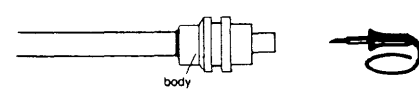

- 3** Trim dielectric flush with mating face, and centre conductor to angle shown. Do not nick centre conductor.

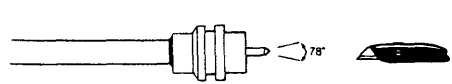

- 4** Fit retaining ring into body groove. Push plain gasket over body to butt against shoulder.

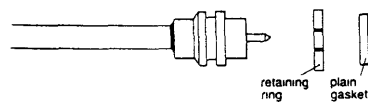

- 5** Fit assembly into coupling nut.

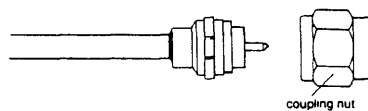

- 6**

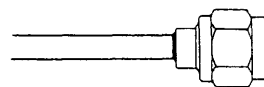

[SMA 002]

Assembly instructions

Instruction (a)

- 1** Clean outer conductor. Trim back outer conductor to dimension shown

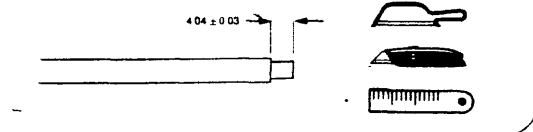

- 2** Insert body until outer sheath butts against internal shoulder of body. Soft solder outer conductor to body

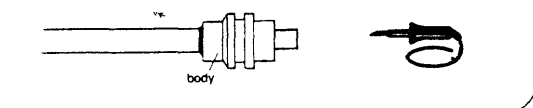

- 3** Trim dielectric flush with mating face, and centre conductor to angle shown. Do not nick centre conductor

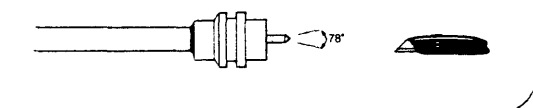

- 4** Fit retaining ring into body groove. Push plain gasket over body to butt against shoulder

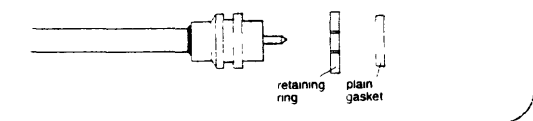

- 5** Fit assembly into coupling nut

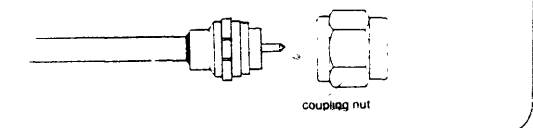

6

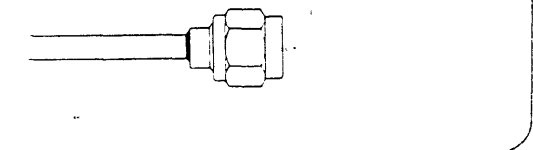

[SMA 003]

Instruction (b)

- 1** Clean outer conductor. Trim back outer conductor and dielectric to dimension shown. Do not nick centre conductor

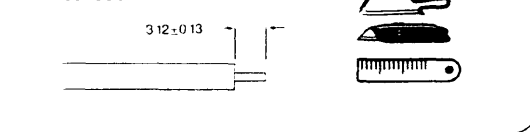

- 2** Tin centre conductor and insert cable into body. Position centre conductor into slot of contact and solder. Soft solder outer conductor to body

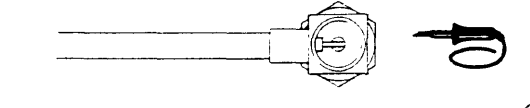

- 3** Soft solder or press fit access cap as appropriate

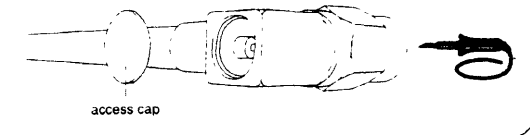

[SMA 004]

Assembly instructions

Instruction (a)

- 1** Clean outer conductor. Trim back outer conductor and dielectric to dimension shown. Do not nick centre conductor



- 2** Solder contact to centre conductor, allow a gap of 0.38mm (0.015") by using a spacer or shim

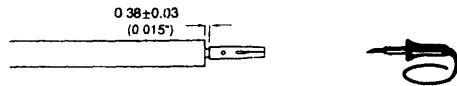

- 3** Inset assembly into body until butted against insulator. Soft solder outer conductor to body

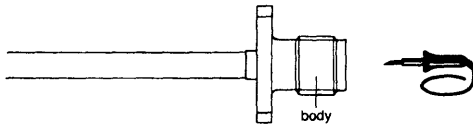

- 4** Captivate contact using low loss epoxy adhesive. Cure using heat

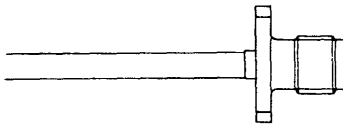

Instruction (b)

- 1** Slide shrink sleeve and crimp sleeve over cable. Trim to dimensions shown in the table below. Do not nick the braid or the centre conductor

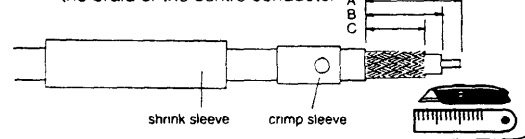

- 2** Solder contact to centre conductor ensuring contact is firmly against cable dielectric, remove excess solder

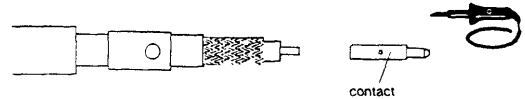

- 3** Insert assembly into body until cable dielectric butts against the internal shoulder of body. The ferrule should go over the dielectric and under the braid

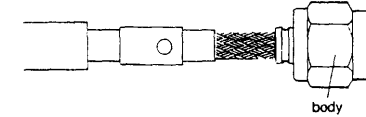

- 4** Slide crimp sleeve to butt against body and crimp using the die specified below

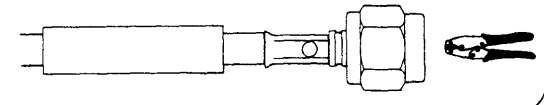

- 5** Slide shrink sleeve to butt against body and carefully apply heat, (300°-400°C)

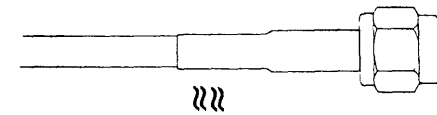

* Note as an alternative to crimping, the cable braid can be soft soldered to the crimp sleeve and connector body, by allowing solder to flow into the crimp sleeve access holes. Pre-tinning of the ferrule outer diameter in the braid overlap area is recommended.

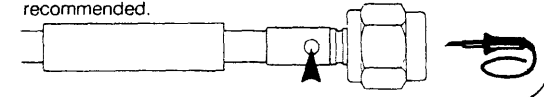

Cable Group	Trimming Dimensions			Die Size
	A	B	C	
10 or 60	10.1	8.1	6.4	5.41
22	10.2	8.2	5.3	3.25

[SMA 005]

[SMA 006]

Assembly instructions

Instruction (a)

- 1** Slide shrink sleeve and crimp sleeve over cable. Trim to dimensions shown in the table below. Do not nick the braid or the centre conductor.

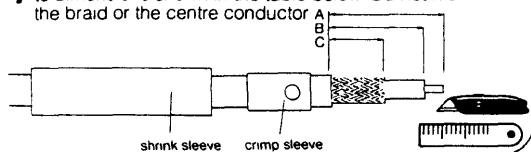

- 2** Tin centre conductor and insert cable into body. The ferrule should go over the dielectric and under the braid.

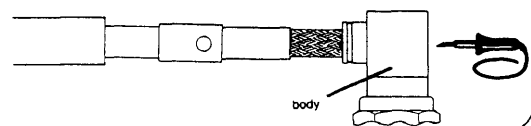

- 3** Slide the crimp sleeve to butt against the body. Crimp using the die specified below.

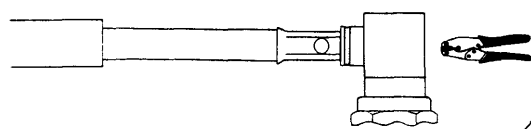

- 4** Soft solder the centre conductor into slot in contact.

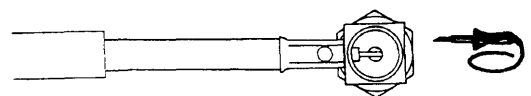

- 5** Slide shrink sleeve to butt against body and carefully apply heat (300°-400°C).

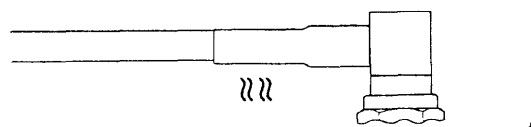

- 6** Soft solder or press fit access cap as appropriate.

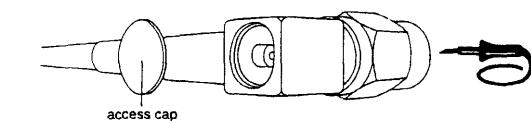

* Note: as an alternative to crimping, the cable braid can be soft soldered to the crimp sleeve and connector body, by allowing solder to flow into the crimp sleeve access holes. Pre-tinning of the ferrule outer diameter in the braid overlap area is recommended.

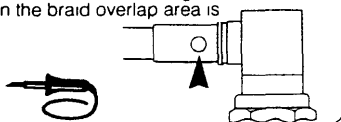

Cable Group	Trimming Dimensions			Die Size
	A	B	C	
10 or 60	13.5	11.9	6.4	5.41
22	11.6	9.9	5.3	3.25

[SMA 007]

Instruction (b)

- 1** Slide shrink sleeve and crimp sleeve over cable. Trim to dimensions shown in the table below. Do not nick the braid.

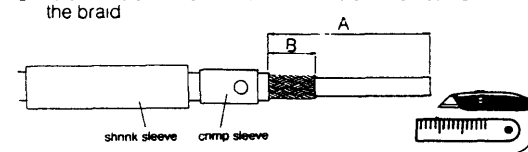

- 2** Insert cable in the ferrule, the ferrule should go over the dielectric and under the braid.

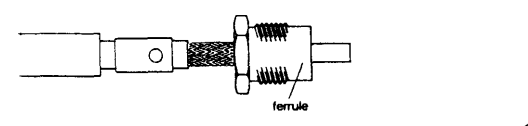

- 3** Slide crimp sleeve to butt against the ferrule and crimp using the die specified below.

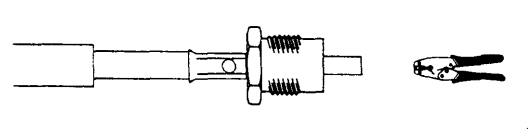

- 4** Slide shrink sleeve against ferrule and carefully apply heat (300°-400°C).

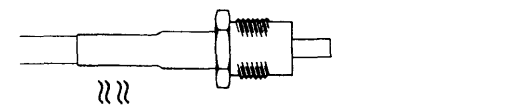

- 5** Trim dielectric flush and the centre conductor as shown. Do not nick the centre conductor.

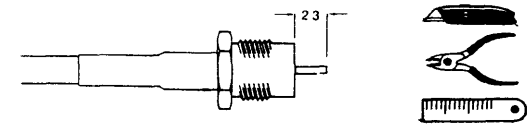

- 6** Assemble insulator and soft solder contact to centre conductor, ensure that flange on contact is fitted firmly against insulator. Remove excess solder.

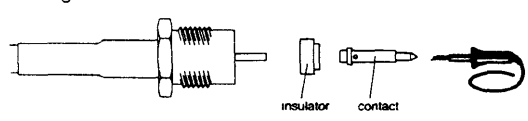

- 7** Insert assembly into body. Tighten clamp nut (1.7-2.3Nm/15-20 pounds-inches).

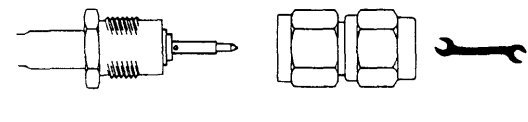

Cable Group	Trimming Dimensions		Die Size
	A	B	
10 or 60	18	6.5	5.41
22	17	5.5	3.25

[SMA 008]

Assembly instructions

Instruction (a)

- 1** Slide clamp nut over cable and trim to dimension shown. Do not nick the braid.

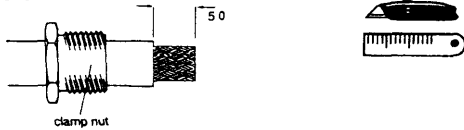

- 2** Flare out braid and insert ferrule over dielectric slitting sheath as necessary.

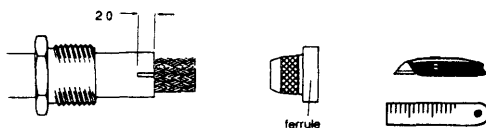

- 3** Trim braid to ferrule outer dia. Trim dielectric flush with front face of ferrule. Do not nick centre conductor. Trim centre conductor to dimensions shown.

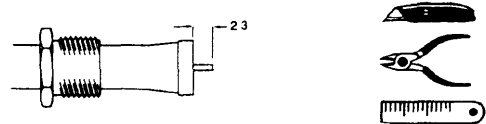

- 4** Assemble insulator and soft solder contact to centre conductor, ensure that flange on contact is fitted firmly against insulator. Remove excess solder.

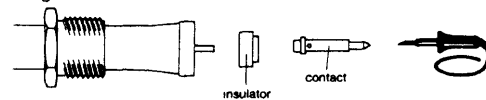

- 5** Insert assembly into body. Tighten clamp nut (1.7-2.3 Nm/15-20 pound inches).

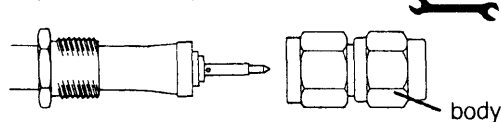

Instruction (b)

- 1** Slide clamp nut over cable and trim to dimension shown. Do not nick the braid.

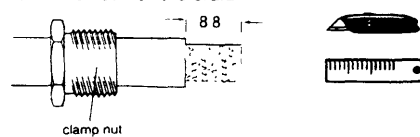

- 2** Flare out braid and insert ferrule over dielectric slitting sheath as necessary.

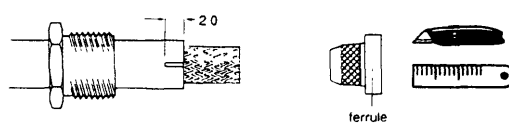

- 3** Trim braid to ferrule outer dia. Trim dielectric and centre conductor to dimensions shown. Do not nick centre conductor. Tin centre conductor.

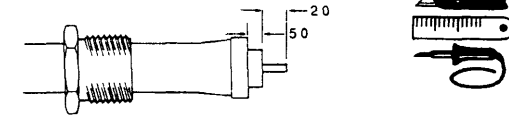

- 4** Insert Ferrule assembly into body and tighten clamp nut (1.7-2.3 Nm, 15-20 pound inches).

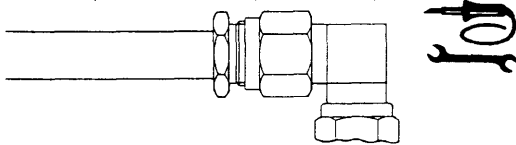

- 5** Soft solder centre conductor into slot in contact.

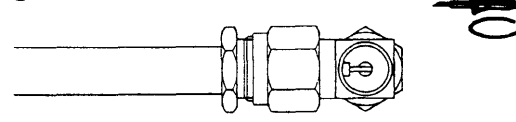

- 6** Soft solder or press fit access cap as appropriate.

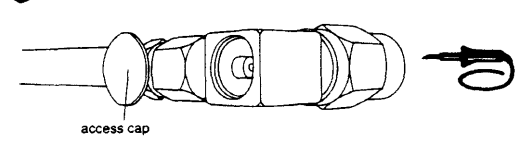

[SMA 009]

[SMA 010]

Assembly instructions

Instruction (a)

- 1** Slide shrink sleeve and crimp sleeve over the cable. Trim cable to the dimensions shown in the table below. Do not nick the braid or centre conductor.

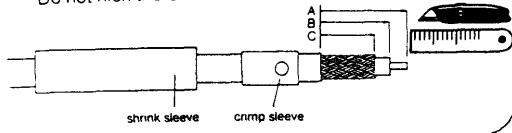

- 2** Solder contact to centre conductor ensuring contact is firmly against cable dielectric. Remove excess solder.

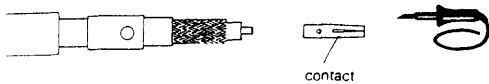

- 3** Insert assembly into body until cable dielectric butts against the internal shoulder of body. The ferrule should go over the dielectric and under the braid.

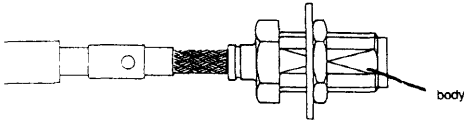

- 4** Slide crimp sleeve to butt against body and crimp using the die specified below.

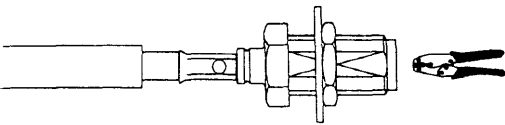

- 5** Slide shrink sleeve to butt against body and carefully apply heat (300°-400°C).

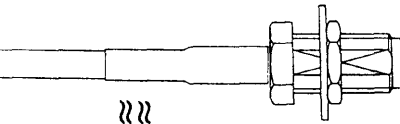

* Note: as an alternative to crimping, the cable braid can be soft soldered to the crimp sleeve and connector body, by allowing solder to flow into the crimp sleeve access holes. Pre-tinning of the ferrule outer diameter in the braid overlap area is recommended.

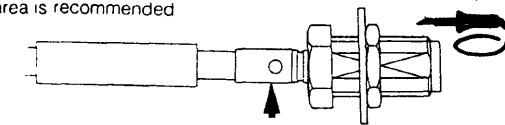

Cable Group	Trimming Dimensions			Die Size
	A	B	C	
10 or 60	16.2	14.2	6.4	5.41
22	16.3	14.3	5.3	3.25

Instruction (b)

- 1** Slide shrink sleeve over cable and trim outer sheath to dimension shown in the table below. Heavily tin conductor allowing solder to run inside the outer sheath.

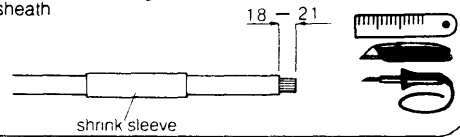

- 2** Carefully trim cable to dimensions shown in the table below. Keep the outer conductor bonded together by the solder.

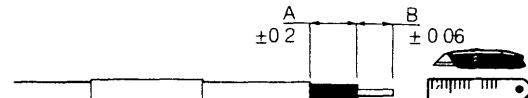

- 3** Solder contact to centre conductor. Allow gap 'C' shown in the table below by using a shim or spacer.

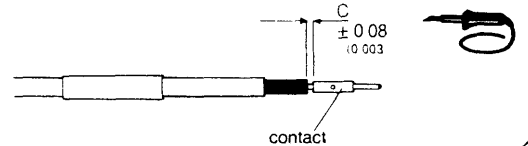

- 4** Insert assembly into body until butted against insulator. Soft solder outer conductor to body.

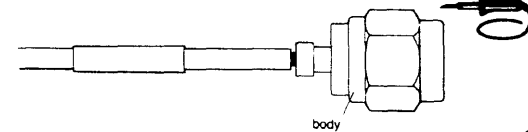

- 5** Roughen outer sheath and slide shrink sleeve over rear of the assembly. Apply heat (300°-400°C).

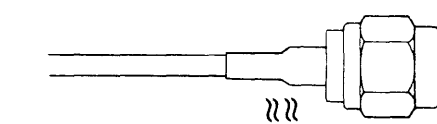

connector	A	B
A65 A03	5.1	3.56
A65 E03	5.9	2.16
A65 H01	12.3	2.16
A65 H02	12.3	2.16

cable	dimension C
50H101	0.38 (0.015)
50H155	0.25 (0.010)

[SMA 011]

[SMA 012]