

Dual Differential Comparators

LM2903

DESCRIPTION:

The LM2903 consists of two independent voltage comparators with an offset voltage specification as low as 2.0mV max. for two comparators which were designed specifically to operation from a single power supply over a wide range of voltages. Operate from split power supplies is also possible, and the low power supply current drain is independent of the magnitude of the power supply voltage. These comparators also have a unique characteristic in that the input common-mode voltage range includes ground, even though operated from a single power supply voltage.

FEATURE:

- Wide supply voltage range: single supply operation: 2V to 36V dual supply operation: $\pm 1V$ to $\pm 18V$
- Very low supply current drain (0.8mA) independent of supply voltage (2.0mW/comparator at 5.0 VDC)
- Low input biasing current: 25nA
- Low input offset current: 5.0nA; Low input offset voltage: 5.0mV
- Input common-mode voltage range includes ground
- Differential input voltage range equal to the power supply voltage
- Output voltage compatible with TTL, DTL, ECL, MOS and CMOS logic systems.

Outline Drawing

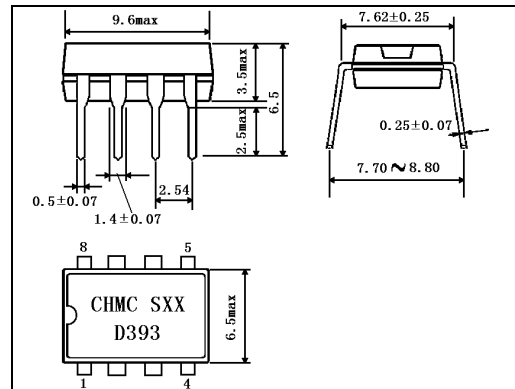

DIP8

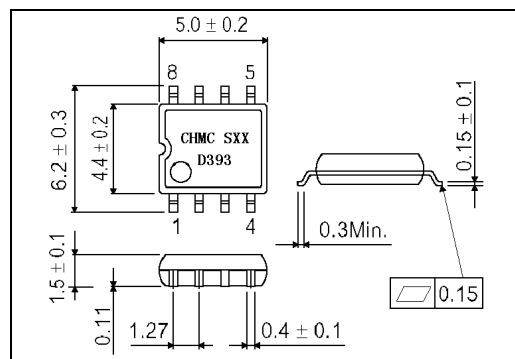

SOP8

BLOCK DIAGRAM

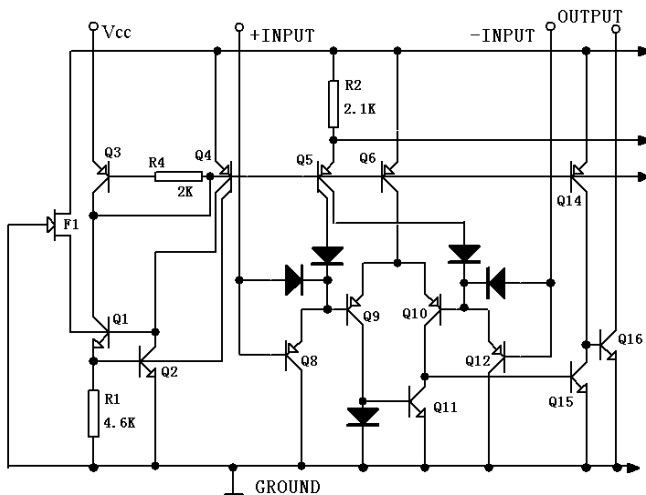

PIN CONFIGURATION

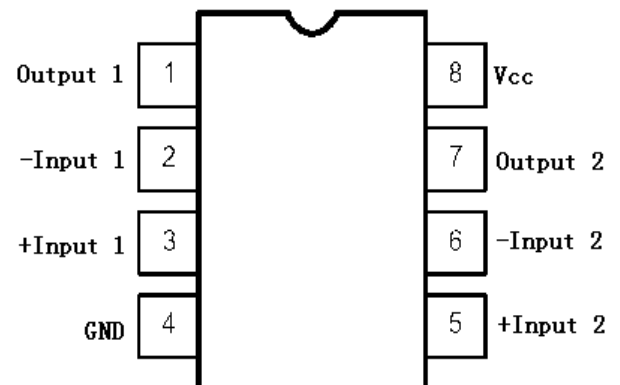

PIN DESCRIPTIONS

No	Description	Symbol	No	Description	Symbol
1	Output 1	OUT1	5	+Input2	IN2 (+)
2	-Input1	IN1 (-)	6	-Input2	IN2 (-)
3	+Input1	IN1 (+)	7	Output 2	OUT1
4	Ground	GND	8	Supply Voltage	Vcc

ABSOLUTE MAXIMUM RATINGS

Characteristics		Symbol	Min.	Max.	Unit
Supply Voltage	Single supply voltage	Vcc		±18	V
	Dual supplies voltage			36	
Differential Input Voltage		V _{IDR}		36	V
Input common-mode voltage		V _{ICR}	-0.3	36	V
Output short-circuit to ground		I _{OG}		20	mA
Input Current		I _{IN}		50	mA
Maximum junction temperature		T _J		125	°C
Power Dissipation	DIP8	P _D		570	mW
	SOP8			300	
Operating Temperature Range		T _{amb}	-20	+85	°C
Storage Temperature Range		T _{stg}	-65	150	°C

ELECTRICAL CHARACTERISTICS (Unless otherwise specified :Vcc=5V, T_{amb}=25°C)

Characteristics	Test conditions	Symbo	Mi	Typ.	Max	Unit
Input Offset Voltage		V _{IO}		±1.0	±5.0	mV
	0°C ≤ T _a ≤ 70°C				±9.0	
Input Offset Current		I _{IO}		±5.0	±50	nA
	0°C ≤ T _a ≤ 70°C				±150	
Input Bias Current		I _{IB}		25	250	nA
	0°C ≤ T _a ≤ 70°C				400	
Input Common-mode Voltage Range		V _{ICR}	0		Vcc-1.5	V
	0°C ≤ T _a ≤ 70°C		0		Vcc-2.0	
Supply Current	R _L =∞ dual comparator	I _{CC}		0.4	1.0	mA
	R _L =∞, dual comparator Vcc=30V				2.5	
Voltage Gain	R _L ≥ 15KΩ, Vcc=15V	G _V	50	200		V/mV
Large Signal Response Time	V _{IN} =TTL Logic Swing, V _{REF} =1.4V, V _{RL} =5.0V, R _L =5.1KΩ	t _{RES}		300		ns
Response Time	V _{RL} =5.0V, R _L =5.1KΩ	t _{RES}		1.3		ns
Input Differential Voltage		V _{ID}			Vcc	V
Output Sink Current	V _{IN} (-) ≥ 1.0V, V _{IN} (+) =0V, V _O ≤ 1.5V	I _{SINK}	6.0	16		mA
output saturation voltage	V _{IN} (-) ≥ 1.0V, V _{IN} (+) =0V, I _{SINK} ≤ 4.0mA	V _{SAT}		130	400	mV
	V _{IN} (-) ≥ 1.0V, V _{IN} (+) =0V, I _{SINK} ≤ 4.0mA 0°C ≤ T _a ≤ 70°C				700	
Output Leakage Current	V _{IN} (+) ≥ 1.0V, V _{IN} (-) =0V, V _O =5.0V	I _{OL}		0.1		nA
	V _{IN} (+) ≥ 1.0V, V _{IN} (-) =0V, V _O =30V 0°C ≤ T _a ≤ 70°C				1000	

APPLICATION CIRCUIT

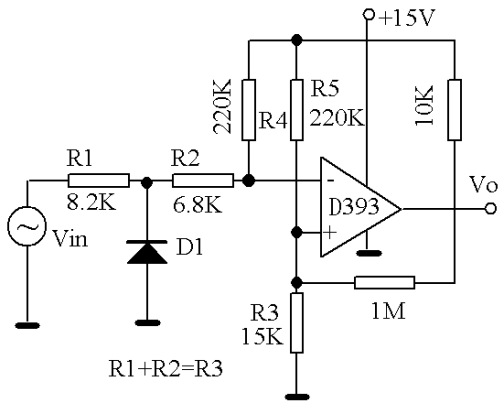

Applied single power Supply

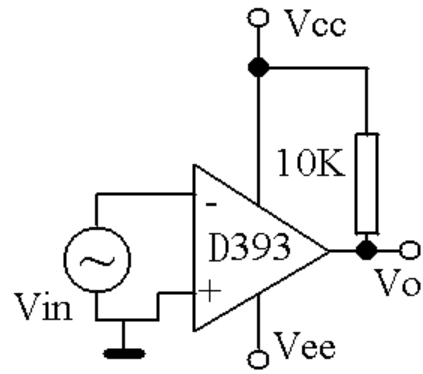

Applied split power supplies

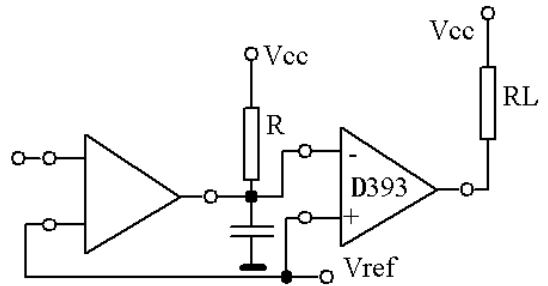
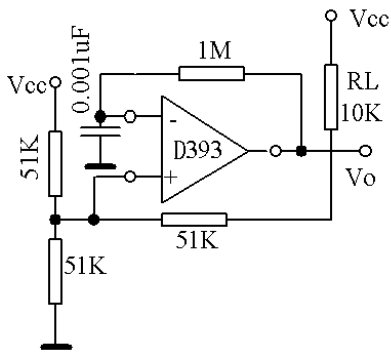

TYPICAL CHARACTERISTICS CURVES:

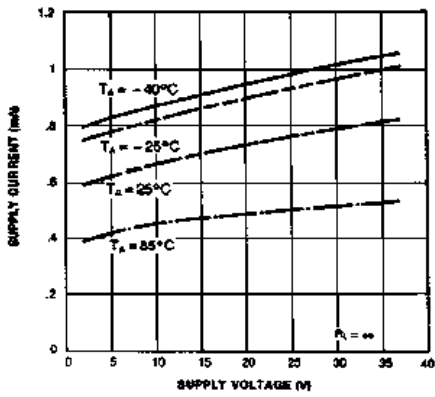

Figure 1. Supply Current vs Supply Voltage

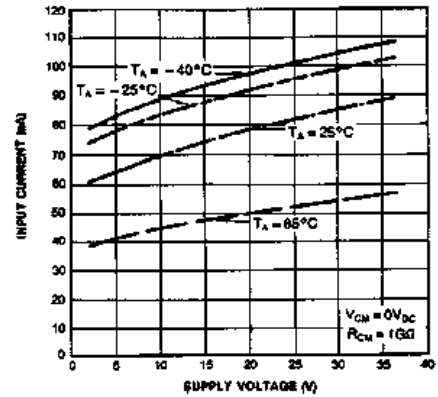

Figure 2. Input Current vs Supply Voltage

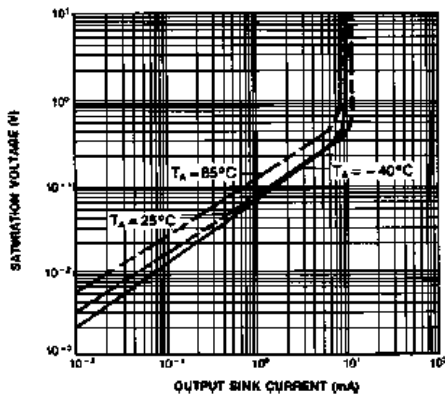

Figure 3. Output Saturation Voltage vs Sink Current

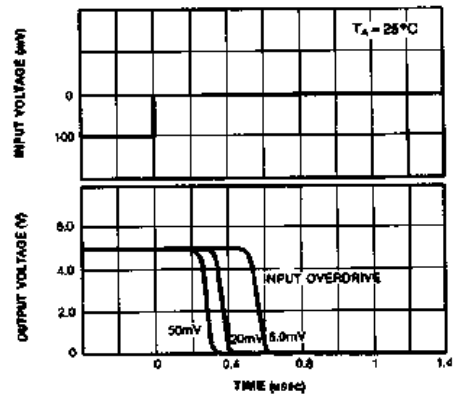

Figure 4. Response Time for Various Input Overdrive-Negative Transition

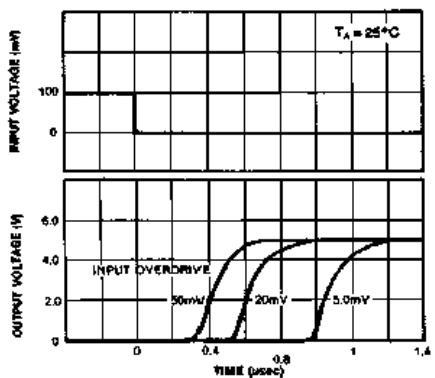

Figure 5. Response Time for Various Input Overdrive-Positive Transition