



STD10PF06

P-CHANNEL 60V - 0.18 Ω - 10A IPAK/DPAK STripFET™ II POWER MOSFET

| TYPE | V _{DSS} | R _{DS(on)} | I _D |
|-----------|------------------|---------------------|----------------|
| STD10PF06 | 60 V | < 0.20 Ω | 10 A |

- TYPICAL R_{DS(on)} = 0.18 Ω
- EXCEPTIONAL dv/dt CAPABILITY
- 100% AVALANCHE TESTED
- LOW GATE CHARGE
- APPLICATION ORIENTED CHARACTERIZATION
- THROUGH-HOLE IPAK (TO-251) POWER PACKAGE IN TUBE (SUFFIX "-1")
- SURFACE-MOUNTING DPAK (TO-252) POWER PACKAGE IN TAPE & REEL (SUFFIX "T4")

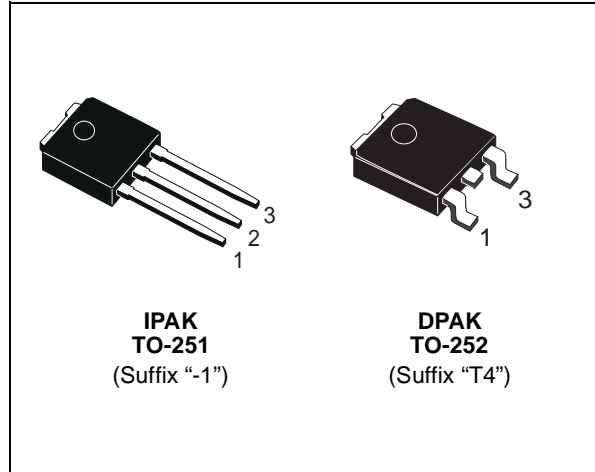

DESCRIPTION

This Power MOSFET is the latest development of STMicroelectronics unique "Single Feature Size™" strip-based process. The resulting transistor shows extremely high packing density for low on-resistance, rugged avalanche characteristics and less critical alignment steps therefore a remarkable manufacturing reproducibility.

APPLICATIONS

- MOTOR CONTROL
- DC-DC & DC-AC CONVERTERS

INTERNAL SCHEMATIC DIAGRAM

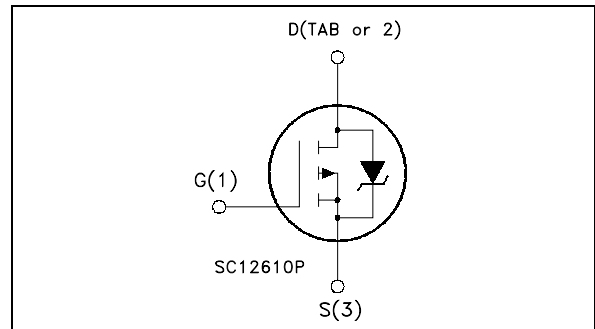

ABSOLUTE MAXIMUM RATINGS

| Symbol | Parameter | Value | Unit |
|---------------------|-------------------------------------------------------|------------|------|
| V _{DS} | Drain-source Voltage (V _{GS} = 0) | 60 | V |
| V _{DGR} | Drain-gate Voltage (R _{GS} = 20 k Ω) | 60 | V |
| V _{GS} | Gate- source Voltage | ± 20 | V |
| I _D | Drain Current (continuous) at T _C = 25°C | 10 | A |
| I _D | Drain Current (continuous) at T _C = 100°C | 7 | A |
| I _{DM} (*) | Drain Current (pulsed) | 40 | A |
| P _{tot} | Total Dissipation at T _C = 25°C | 40 | W |
| | Derating Factor | 0.27 | W/°C |
| dv/dt (1) | Peak Diode Recovery voltage slope | 6 | V/ns |
| T _{stg} | Storage Temperature | -65 to 175 | °C |
| T _j | Max. Operating Junction Temperature | 175 | °C |

(*) Pulse width limited by safe operating area.
Note: P-CHANNEL MOSFET actual polarity of voltages and current has to be reversed

(1) I_{SD} \leq 10A, di/dt \leq 300A/ μ s, V_{DD} \leq V_{(BR)DSS}, T_j \leq T_{JMAX}

STD10PF06**THERMAL DATA**

| | | | | |
|----------------|------------------------------------------------|-----|------|------|
| Rthj-case | Thermal Resistance Junction-case | Max | 3.75 | °C/W |
| Rthj-amb | Thermal Resistance Junction-ambient | Max | 100 | °C/W |
| T _l | Maximum Lead Temperature For Soldering Purpose | | 275 | °C |

AVALANCHE CHARACTERISTICS

| Symbol | Parameter | Max Value | Unit |
|-----------------|----------------------------------------------------------------------------------------------------------------------------|-----------|------|
| I _{AR} | Avalanche Current, Repetitive or Not-Repetitive (pulse width limited by T _j max) | 10 | A |
| E _{AS} | Single Pulse Avalanche Energy (starting T _j = 25 °C, I _D = I _{AR} , V _{DD} = 25 V) | 125 | mJ |

ELECTRICAL CHARACTERISTICS (T_{CASE} = 25 °C UNLESS OTHERWISE SPECIFIED)

OFF

| Symbol | Parameter | Test Conditions | Min. | Typ. | Max. | Unit |
|----------------------|-------------------------------------------------------|-------------------------------------------------------------------------------------|------|------|---------|----------|
| V _{(BR)DSS} | Drain-source Breakdown Voltage | I _D = 250 μA, V _{GS} = 0 | 60 | | | V |
| I _{DSS} | Zero Gate Voltage Drain Current (V _{GS} = 0) | V _{DS} = Max Rating V _{DS} = Max Rating T _C = 125°C | | | 1 10 | μA μA |
| I _{GSS} | Gate-body Leakage Current (V _{DS} = 0) | V _{GS} = ± 20V | | | ±1 | μA |

ON (*)

| Symbol | Parameter | Test Conditions | Min. | Typ. | Max. | Unit |
|---------------------|-----------------------------------|-----------------------------------------------------------|------|------|------|------|
| V _{GS(th)} | Gate Threshold Voltage | V _{DS} = V _{GS} I _D = 250 μA | 2 | | 4 | V |
| R _{DS(on)} | Static Drain-source On Resistance | V _{GS} = 10 V I _D = 5 A | | 0.18 | 0.20 | Ω |

DYNAMIC

| Symbol | Parameter | Test Conditions | Min. | Typ. | Max. | Unit |
|---------------------|------------------------------|------------------------------------------------------|------|------|------|------|
| g _{fs} (*) | Forward Transconductance | V _{DS} = 25 V I _D = 5 A | 2 | 5 | | S |
| C _{iSS} | Input Capacitance | V _{DS} = 25 V f = 1 MHz V _{GS} = 0 | | 850 | | pF |
| C _{oSS} | Output Capacitance | | | 230 | | pF |
| C _{rSS} | Reverse Transfer Capacitance | | | 75 | | pF |

STD10PF06

ELECTRICAL CHARACTERISTICS (continued)

SWITCHING ON

| Symbol | Parameter | Test Conditions | Min. | Typ. | Max. | Unit |
|-------------------------------|--------------------------------------------------------------|-----------------------------------------------------------------------------------------------------------------------|------|--------------|------|----------------|
| $t_{d(on)}$ t_r | Turn-on Delay Time Rise Time | $V_{DD} = 30\text{ V}$ $I_D = 5\text{ A}$ $R_G = 4.7\ \Omega$ $V_{GS} = 10\text{ V}$ (Resistive Load, Figure 3) | | 20 40 | | ns ns |
| Q_g Q_{gs} Q_{gd} | Total Gate Charge Gate-Source Charge Gate-Drain Charge | $V_{DD} = 48\text{ V}$ $I_D = 10\text{ A}$ $V_{GS} = 10\text{ V}$ | | 16 4 6 | 21 | nC nC nC |

SWITCHING OFF

| Symbol | Parameter | Test Conditions | Min. | Typ. | Max. | Unit |
|----------------------------------|-------------------------------------------------------|-----------------------------------------------------------------------------------------------------------------------------|------|----------------|------|----------------|
| $t_{d(off)}$ t_f | Turn-off Delay Time Fall Time | $V_{DD} = 30\text{ V}$ $I_D = 5\text{ A}$ $R_G = 4.7\ \Omega$, $V_{GS} = 10\text{ V}$ (Resistive Load, Figure 3) | | 40 10 | | ns ns |
| $t_r(V_{off})$ t_f t_c | Off-voltage Rise Time Fall Time Cross-over Time | $V_{clamp} = 48\text{ V}$ $I_D = 10\text{ A}$ $R_G = 4.7\ \Omega$, $V_{GS} = 10\text{ V}$ (Inductive Load, Figure 5) | | 10 17 30 | | ns ns ns |

SOURCE DRAIN DIODE

| Symbol | Parameter | Test Conditions | Min. | Typ. | Max. | Unit |
|-----------------------------------|------------------------------------------------------------------------------|-----------------------------------------------------------------------------------------------------------------------------------------------|------|-------------------|----------|--------------------------|
| I_{SD} $I_{SDM} (\bullet)$ | Source-drain Current Source-drain Current (pulsed) | | | | 10 40 | A A |
| $V_{SD} (*)$ | Forward On Voltage | $I_{SD} = 10\text{ A}$ $V_{GS} = 0$ | | | 2.5 | V |
| t_{rr} Q_{rr} I_{RRM} | Reverse Recovery Time Reverse Recovery Charge Reverse Recovery Current | $I_{SD} = 10\text{ A}$ $di/dt = 100\text{ A}/\mu\text{s}$ $V_{DD} = 30\text{ V}$ $T_j = 150^\circ\text{C}$ (see test circuit, Figure 5) | | 100 260 5.2 | | ns μC A |

(*)Pulsed: Pulse duration = 300 μs , duty cycle 1.5 %.

(\bullet)Pulse width limited by safe operating area.

Safe Operating Area

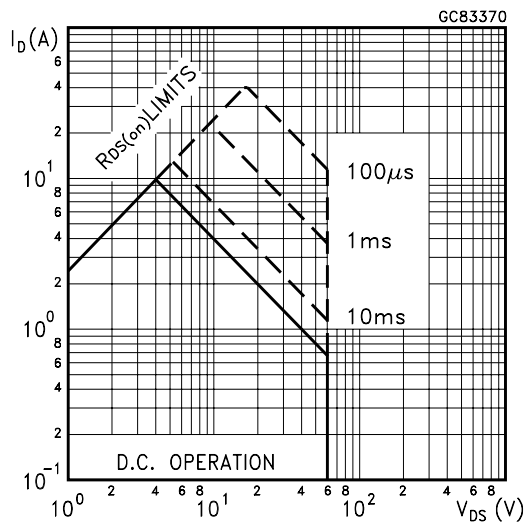

Thermal Impedance

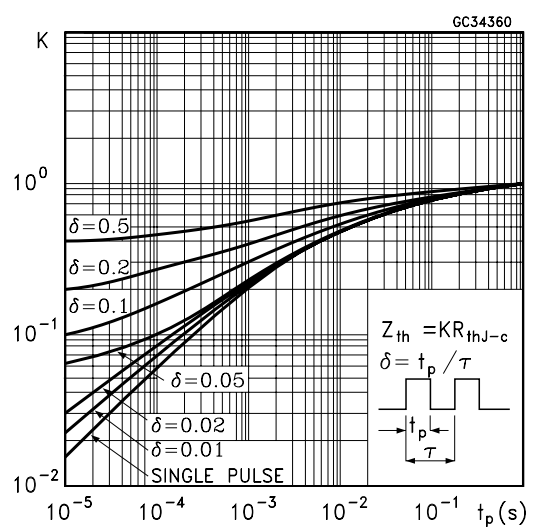

Output Characteristics

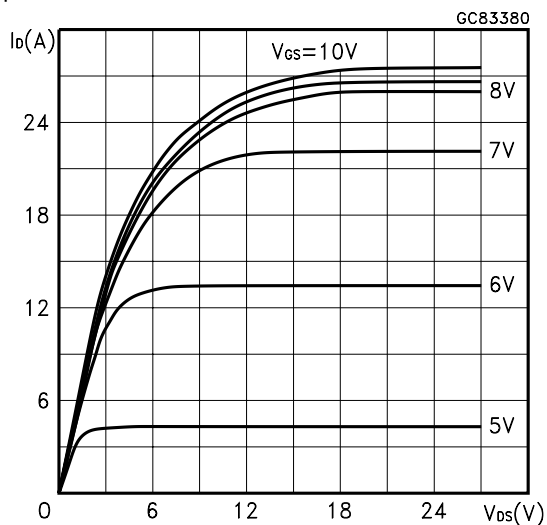

Transfer Characteristics

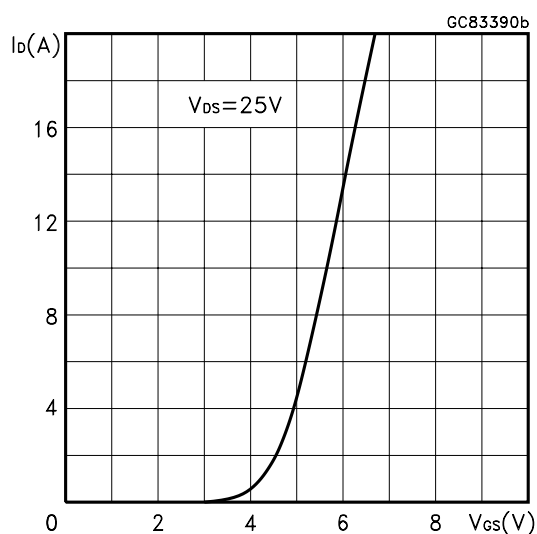

Transconductance

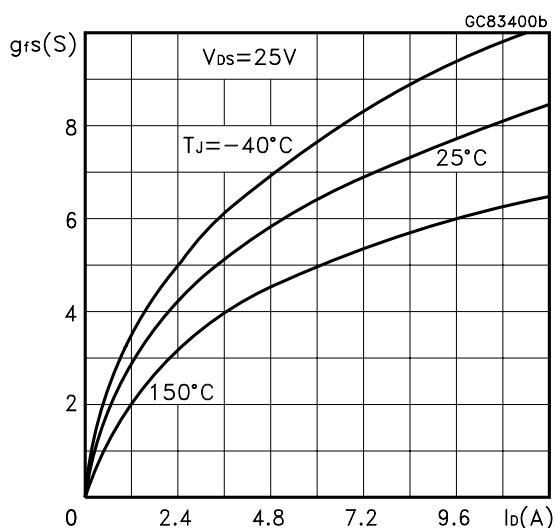

Static Drain-source On Resistance

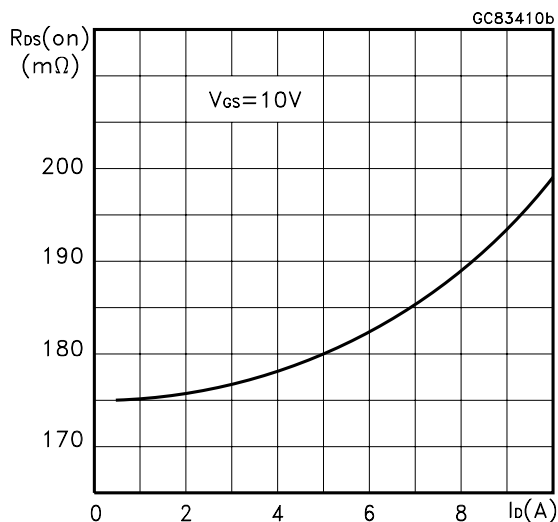

Gate Charge vs Gate-source Voltage

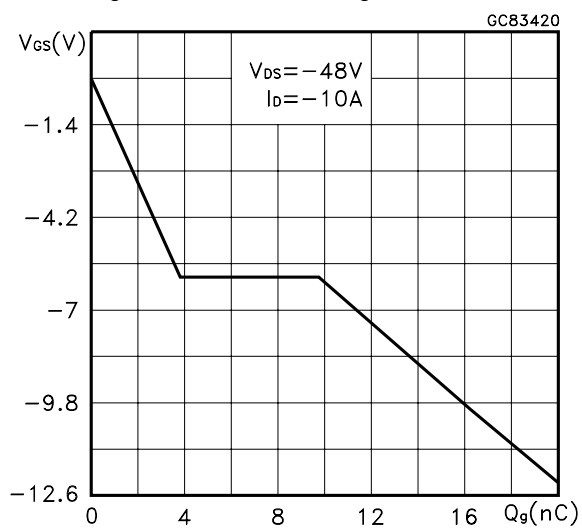

Capacitance Variations

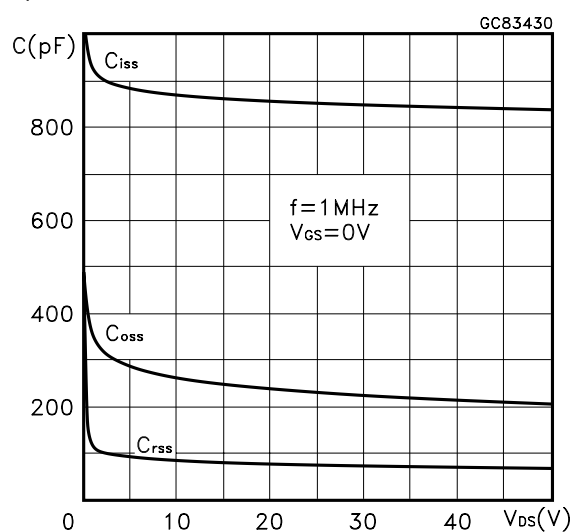

STD10PF06

Normalized Gate Threshold Voltage vs Temperature

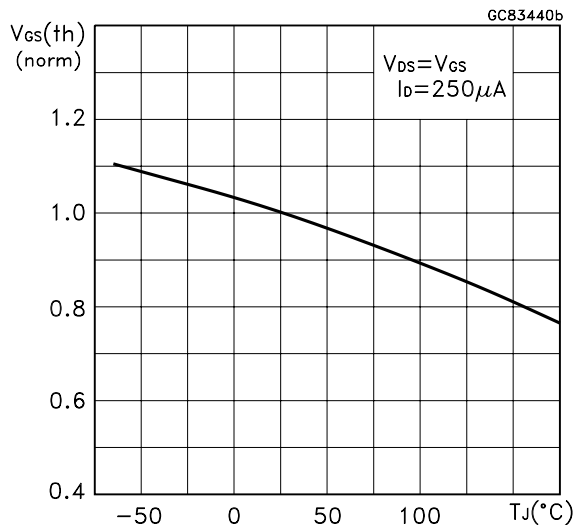

Normalized on Resistance vs Temperature

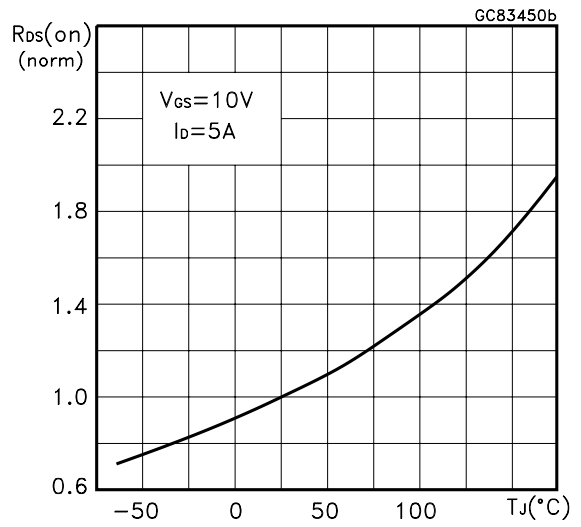

Source-drain Diode Forward Characteristics

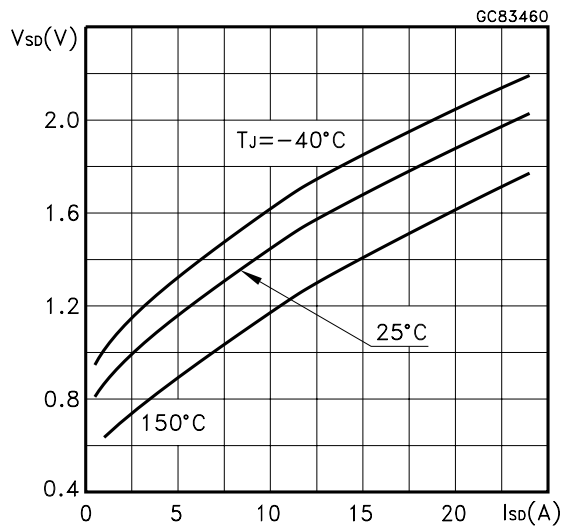

Normalized Breakdown Voltage Temperature

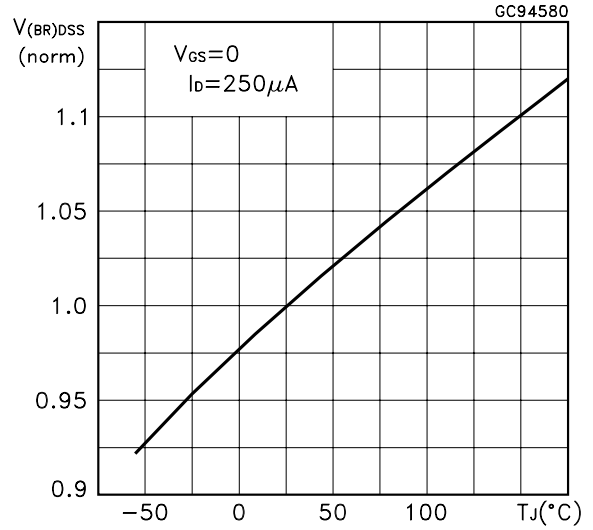

Fig. 1: Unclamped Inductive Load Test Circuit



Fig. 2: Unclamped Inductive Waveform



Fig. 3: Switching Times Test Circuits For Resistive Load



Fig. 4: Gate Charge test Circuit

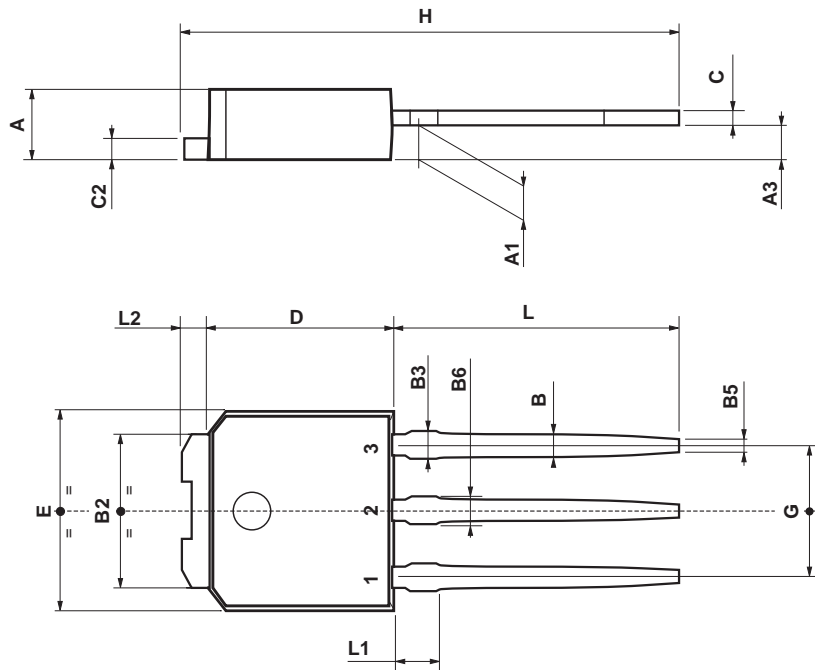

Fig. 5: Test Circuit For Inductive Load Switching And Diode Recovery Times



TO-251 (IPAK) MECHANICAL DATA

| DIM. | mm | | | inch | | |
|------|------|------|------|-------|-------|-------|
| | MIN. | TYP. | MAX. | MIN. | TYP. | MAX. |
| A | 2.2 | | 2.4 | 0.086 | | 0.094 |
| A1 | 0.9 | | 1.1 | 0.035 | | 0.043 |
| A3 | 0.7 | | 1.3 | 0.027 | | 0.051 |
| B | 0.64 | | 0.9 | 0.025 | | 0.031 |
| B2 | 5.2 | | 5.4 | 0.204 | | 0.212 |
| B3 | | | 0.85 | | | 0.033 |
| B5 | | 0.3 | | | 0.012 | |
| B6 | | | 0.95 | | | 0.037 |
| C | 0.45 | | 0.6 | 0.017 | | 0.023 |
| C2 | 0.48 | | 0.6 | 0.019 | | 0.023 |
| D | 6 | | 6.2 | 0.236 | | 0.244 |
| E | 6.4 | | 6.6 | 0.252 | | 0.260 |
| G | 4.4 | | 4.6 | 0.173 | | 0.181 |
| H | 15.9 | | 16.3 | 0.626 | | 0.641 |
| L | 9 | | 9.4 | 0.354 | | 0.370 |
| L1 | 0.8 | | 1.2 | 0.031 | | 0.047 |
| L2 | | 0.8 | 1 | | 0.031 | 0.039 |



0068771-E

TO-252 (DPAK) MECHANICAL DATA

| DIM. | mm | | | inch | | |
|------|------|------|------|-------|-------|-------|
| | MIN. | TYP. | MAX. | MIN. | TYP. | MAX. |
| A | 2.2 | | 2.4 | 0.086 | | 0.094 |
| A1 | 0.9 | | 1.1 | 0.035 | | 0.043 |
| A2 | 0.03 | | 0.23 | 0.001 | | 0.009 |
| B | 0.64 | | 0.9 | 0.025 | | 0.035 |
| B2 | 5.2 | | 5.4 | 0.204 | | 0.212 |
| C | 0.45 | | 0.6 | 0.017 | | 0.023 |
| C2 | 0.48 | | 0.6 | 0.019 | | 0.023 |
| D | 6 | | 6.2 | 0.236 | | 0.244 |
| E | 6.4 | | 6.6 | 0.252 | | 0.260 |
| G | 4.4 | | 4.6 | 0.173 | | 0.181 |
| H | 9.35 | | 10.1 | 0.368 | | 0.397 |
| L2 | | 0.8 | | | 0.031 | |
| L4 | 0.6 | | 1 | 0.023 | | 0.039 |



Information furnished is believed to be accurate and reliable. However, STMicroelectronics assumes no responsibility for the consequences of use of such information nor for any infringement of patents or other rights of third parties which may result from its use. No license is granted by implication or otherwise under any patent or patent rights of STMicroelectronics. Specifications mentioned in this publication are subject to change without notice. This publication supersedes and replaces all information previously supplied. STMicroelectronics products are not authorized for use as critical components in life support devices or systems without express written approval of STMicroelectronics.

The ST logo is registered trademark of STMicroelectronics
© 2002 STMicroelectronics - All Rights Reserved

All other names are the property of their respective owners.

STMicroelectronics GROUP OF COMPANIES

Australia - Brazil - Canada - China - Finland - France - Germany - Hong Kong - India - Israel - Italy - Japan - Malaysia - Malta - Morocco -
Singapore - Spain - Sweden - Switzerland - United Kingdom - United States.

<http://www.st.com>