

**Product Specification**

## SPECIFICATION FOR APPROVAL

- ( ) Preliminary Specification
- (◆) Final Specification

<b>Title</b>	<b>18.5" WXGA TFT LCD</b>
--------------	---------------------------





BUYER	Acer
MODEL	

SUPPLIER	LG Display Co., Ltd.
*MODEL	LM185WH1
SUFFIX	TLA1

\*When you obtain standard approval, please use the above model name without suffix

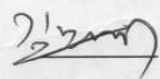
SIGNATURE	DATE
/	_____
/	_____
/	_____

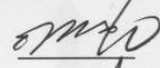
Please return 1 copy for your confirmation  
With your signature and comments.

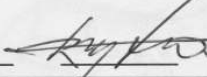
APPROVED BY	DATE
G.T. KIM / G.Manager	
<b>REVIEWED BY</b>	
K.H. Hwang / Manager [C]	
J. H. Lee / Manager [M]	
D.H. Kang / Manager [P]	
<b>PREPARED BY</b>	
S.H. Lee / Engineer	

**Product Engineering Dept.  
LG Display Co., Ltd**

**Product Specification**

# SPECIFICATION FOR APPROVAL

- ( ) Preliminary Specification
- (◆) Final Specification

Title	18.5" WXGA TFT LCD
-------	--------------------

BUYER	Acer
MODEL	

SUPPLIER	LG Display Co., Ltd.
*MODEL	LM185WH1
SUFFIX	TLA1

\*When you obtain standard approval, please use the above model name without suffix

SIGNATURE	DATE
/	_____
/	_____
/	_____

APPROVED BY	DATE
G.T. KIM / G.Manager	_____
<b>REVIEWED BY</b>	
K.H. Hwang / Manager [C]	_____
J. H. Lee / Manager [M]	_____
D.H. Kang / Manager [P]	_____
<b>PREPARED BY</b>	
S.H. Lee / Engineer	_____

Please return 1 copy for your confirmation  
With your signature and comments.

**Product Engineering Dept.  
LG Display Co., Ltd**

## Product Specification

### Contents

No	ITEM	Page
	COVER	1
	CONTENTS	2
	RECORD OF REVISIONS	3
1	GENERAL DESCRIPTION	4
2	ABSOLUTE MAXIMUM RATINGS	5
3	ELECTRICAL SPECIFICATIONS	6
	1) ELECTRICAL CHARACTERISTICS	6
	2) INTERFACE CONNECTIONS	9
	3) LVDS characteristics	12
	4) SIGNAL TIMING SPECIFICATIONS	15
	5) SIGNAL TIMING WAVEFORMS	16
	6) COLOR INPUT DATA REFERNECE	17
	7) POWER SEQUENCE	18
	8) POWER DIP CONDITION	19
4	OPTICAL SFECIFICATIONS	20
5	MECHANICAL CHARACTERISTICS	25
6	RELIABILITY	28
7	INTERNATIONAL STANDARDS	29
	1) SAFETY	29
	2) EMC	29
8	PACKING	30
	1) DESIGNATION OF LOT MARK	30
	2) PACKING FORM	30
9	PRECAUTIONS	31
	1) MOUNTING PRECAUTIONS	31
	2) OPERATING PRECAUTIONS	31
	3) ELECTROSTATIC DISCHARGE CONTROL	32
	4) PRECAUTIONS FOR STRONG LIGHT EXPOSURE	32
	5) STROAGE	32
	6) HANDLING PRECAUTIONS FOR PROTECTION FILM	32



**Product Specification**

**1. General description**

LM185WH1-TLA1 is a Color Active Matrix Liquid Crystal Display with an integral Cold Cathode Fluorescent Lamp(CCFL) backlight system. The matrix employs a-Si Thin Film Transistor as the active element. It is a transmissive type display operating in the normally white mode. It has a 18.5 inch diagonally measured active display area with WXGA resolution (768 vertical by 1366 horizontal pixel array) Each pixel is divided into Red, Green and Blue sub-pixels or dots which are arranged in vertical stripes. Gray scale or the brightness of the sub-pixel color is determined with a 8-bit gray scale signal for each dot, thus, presenting a palette of more than 16,7M colors with Advanced-FRC(Frame Rate Control). It has been designed to apply the interface method that enables low power, high speed, low EMI. FPD Link or compatible must be used as a LVDS(Low Voltage Differential Signaling) chip. It is intended to support applications where thin thickness, wide viewing angle, low power are critical factors and graphic displays are important. In combination with the vertical arrangement of the sub-pixels, the LM185WH1-TLA1 characteristics provide an excellent flat panel display for office automation products such as monitors.

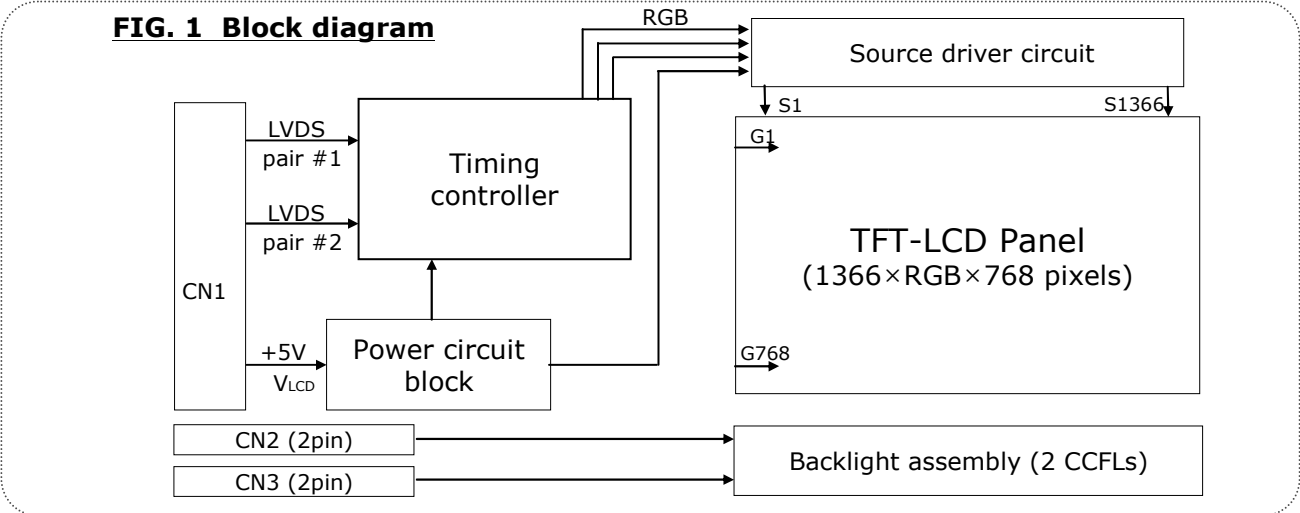

**General features**

Active screen size	18.51 inches (470.1mm) diagonal
Outline Dimension	430.4(H) x 254.6(V) x 13.0(D) mm(Typ.)
Pixel Pitch	0.10*RGB(H)mm x 0.30(V)mm
Pixel Format	1366 horizontal By 768 vertical Pixels. RGB stripe arrangement
Interface	LVDS 2Port
Color depth	16.7M colors
Luminance, white	300 cd/m <sup>2</sup> ( Center 1Point, typ)
Viewing Angle (CR>10)	R/L 170(Typ.), U/D 160(Typ.)
Power Consumption	Total 13.60W(Typ.), (3.10W@V <sub>LCD</sub> , 10.50 W@I <sub>BL</sub> =7.5mA)
Weight	1550 g (Typ.)
Display operating mode	Transmissive mode, Normally White
Surface treatments	Hard coating (3H), Anti-glare treatment of the front polarizer



**Product Specification**

**3. Electrical specifications**

**3-1. Electrical characteristics**

It requires two power inputs. One is employed to power the LCD electronics and to drive the TFT array and liquid crystal. The second input power for the CCFL/Backlight, is typically generated by an inverter. The inverter is an external unit to the LCDs.

**Table 2. Electrical characteristics**

Parameter	Symbol	Values			Unit	Notes
		Min	Typ	Max		
MODULE :						
Power Supply Input Voltage	$V_{LCD}$	4.5	5.0	5.5	Vdc	
Permissive Power Input Ripple	$V_{LCD}$	-	-	0.2	V	3
Power Supply Input Current	$I_{LCD-MOSAIC}$	-	620	715	mA	1
	$I_{LCD-BLACK}$	-	720	830	mA	2
Power Consumption	$P_{LCD}$	-	3.10	3.58	Watt	1
Inrush current	$I_{RUSH}$	-	-	3.0	A	3

Note :

1. The specified current and power consumption are under the  $V_{LCD}=5.0V$ ,  $25 \pm 2^{\circ}C$ ,  $f_v=60Hz$  condition whereas mosaic pattern(8 x 6) is displayed and  $f_v$  is the frame frequency.
2. The current is specified at the maximum current pattern.
3. Permissive power ripple should be measured under  $VCC=5.0V$ ,  $25^{\circ}C$ ,  $f_v$  (frame frequency)=75Hz condition and At that time, we recommend the bandwidth configuration of oscilloscope is to be under 20MHz.
4. The duration of rush current is about 5ms and rising time of power Input is  $500\mu s \pm 20\%$ .

**FIG.3 pattern for Electrical characteristics**

power consumption measurement

White : 255Gray  
Black : 0Gray

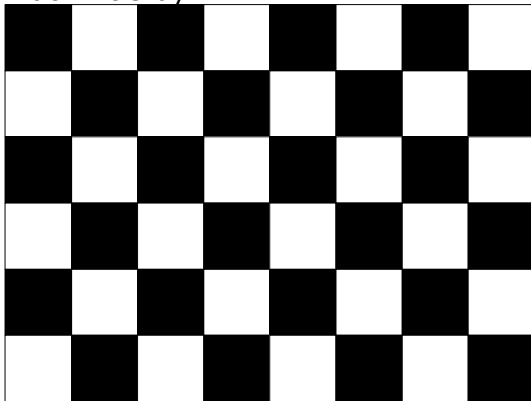

Mosaic Pattern(8 x 6)

power input ripple

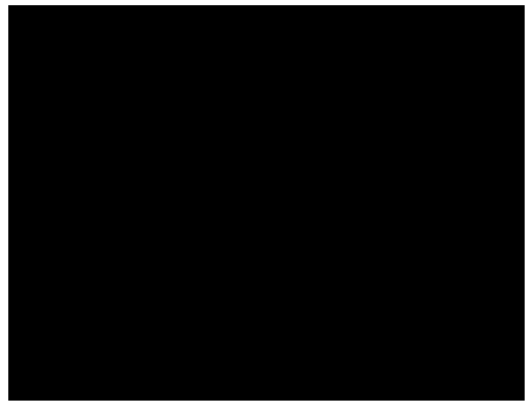

Full Black Pattern

## Product Specification

**Table 3. Electrical characteristics**

Parameter	Symbol	Values			Unit	Notes
		Min	Typ	Max		
<b>LAMP :</b>						
Operating Voltage	$V_{BL}$	685 (8.0mA)	700 (7.5mA)	860 (3.0mA)	$V_{RMS}$	1, 2
Operating Current	$I_{BL}$	3.0	7.5	8.0	$mA_{RMS}$	1
Established Starting Voltage	$V_S$					1, 3
	at 25 °C			1250	$V_{RMS}$	
	at 0 °C			1550	$V_{RMS}$	
Operating Frequency	$f_{BL}$	40	60	70	KHz	4
Discharge Stabilization Time	$T_S$	-	-	3	Min	1, 5
Power Consumption	$P_{BL}$		10.50	10.96	Watt	6
Life Time		50,000	-		Hrs	1, 7

**Note :**

The design of the inverter must have specifications for the lamp in LCD Assembly.

The performance of the Lamp in LCM, for example life time or brightness, is extremely influenced by the characteristics of the DC-AC inverter. So all the parameters of an inverter should be carefully designed so as not to produce too much leakage current from high-voltage output of the inverter.

When you design or order the inverter, please make sure unwanted lighting caused by the mismatch of the lamp and the inverter (no lighting, flicker, etc) never occurs. When you confirm it, the LCD-Assembly should be operated in the same condition as installed in you instrument.

- ※ Do not attach a conducting tape to lamp connecting wire. If the lamp wire attach to a conducting tape, TFT-LCD Module has a low luminance and the inverter has abnormal action.  
 Because leakage current is occurred between lamp wire and conducting tape.

1. Specified values are for a single lamp.
2. Operating voltage is measured at  $25 \pm 2^\circ\text{C}$ . The variance of the voltage is  $\pm 10\%$ .
3. The voltage above  $V_S$  should be applied to the lamps for more than 1 second for start-up.  
 (Inverter open voltage must be more than lamp starting voltage.)

Otherwise, the lamps may not be turned on. The used lamp current is the lamp typical current.

4. Lamp frequency may produce interface with horizontal synchronous frequency and as a result this may cause beat on the display. Therefore lamp frequency shall be as away possible from the horizontal synchronous frequency and from its harmonics in order to prevent interference.
5. Let's define the brightness of the lamp after being lighted for 5 minutes as 100%.  
 $T_S$  is the time required for the brightness of the center of the lamp to be not less than 95%.
6. The lamp power consumption shown above does not include loss of external inverter.  
 The used lamp current is the lamp typical current. ( $P_{BL} = V_{BL} \times I_{BL} \times N_{Lamp}$  )
7. The life is determined as the time at which brightness of the lamp is 50% compared to that of initial value at the typical lamp current on condition of continuous operating at  $25 \pm 2^\circ\text{C}$ .



**Product Specification**

Note :

8. The output of the inverter must have symmetrical(negative and positive) voltage waveform and symmetrical current waveform (Unsymmetrical ratio is less than 10%). Please do not use the inverter which has unsymmetrical voltage and unsymmetrical current and spike wave. Requirements for a system inverter design, which is intended to have a better display performance, a better power efficiency and a more reliable lamp, are following. It shall help increase the lamp lifetime and reduce leakage current.

a. The asymmetry rate of the inverter waveform should be less than 10%.

b. The distortion rate of the waveform should be within  $\sqrt{2} \pm 10\%$ .

\* Inverter output waveform had better be more similar to ideal sine wave.

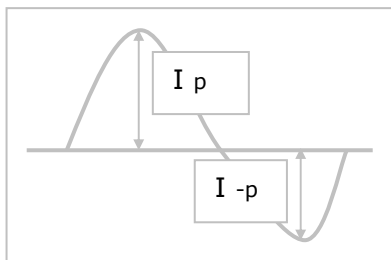

\* Asymmetry rate:

$$| I_p - I_{-p} | / I_{rms} \times 100\%$$

\* Distortion rate

$$I_p \text{ (or } I_{-p}) / I_{rms}$$

9. The inverter which is combined with this LCM, is highly recommended to connect coupling(ballast) condenser at the high voltage output side. When you use the inverter which has not coupling(ballast) condenser, it may cause abnormal lamp lighting because of biased mercury as time goes.

10. In case of edgy type back light with over 4 parallel lamps, input current and voltage wave form should be synchronized

## Product Specification

### 3-2. Interface connections

LCD connector(CN1) : IS100-L30B-C23 (UJU), 187024-30091 (P-TWO)

Mating connector : FI-X30H and FI-X30HL (JAE) or Equivalent

**Table 4. Module connector(CN1) pin configuration**

Pin No	Symbol	Description
1	RXO0-	Minus signal of 1st channel 0 (LVDS)
2	RXO0+	Plus signal of 1st channel 0 (LVDS)
3	RXO1-	Minus signal of 1st channel 1 (LVDS)
4	RXO1+	Plus signal of 1st channel 1 (LVDS)
5	RXO2-	Minus signal of 1st channel 2 (LVDS)
6	RXO2+	Plus signal of 1st channel 2 (LVDS)
7	GND	Ground (AGP)
8	RXOC-	Minus signal of 1st clock channel (LVDS)
9	RXOC+	Plus signal of 1st clock channel (LVDS)
10	RXO3-	Minus signal of 1st channel 3 (LVDS)
11	RXO3+	Plus signal of 1st channel 3 (LVDS)
12	RXE0-	Minus signal of 2nd channel 0 (LVDS)
13	RXE0+	Plus signal of 2nd channel 0 (LVDS)
14	GND	Ground
15	RXE1-	Minus signal of 2nd channel 1 (LVDS)
16	RXE1+	Plus signal of 2nd channel 1 (LVDS)
17	GND	Ground
18	RXE2-	Minus signal of 2nd channel 2 (LVDS)
19	RXE2+	Plus signal of 2nd channel 2 (LVDS)
20	RXEC-	Minus signal of 2nd clock channel (LVDS)
21	RXEC+	Plus signal of 2nd clock channel (LVDS)
22	RXE3-	Minus signal of 2nd channel 3 (LVDS)
23	RXE3+	Plus signal of 2nd channel 3 (LVDS)
24	GND	Ground
25	NC	No Connection (For LCD internal use only.)
26	NC	No Connection (For LCD internal use only.)
27	PWM_OUT	Reference signal for inverter control
28	V <sub>LCD</sub>	Power Supply (5.0V)
29	V <sub>LCD</sub>	Power Supply (5.0V)
30	V <sub>LCD</sub>	Power Supply (5.0V)

**Product Specification**

**FIG. 4 Connector diagram**

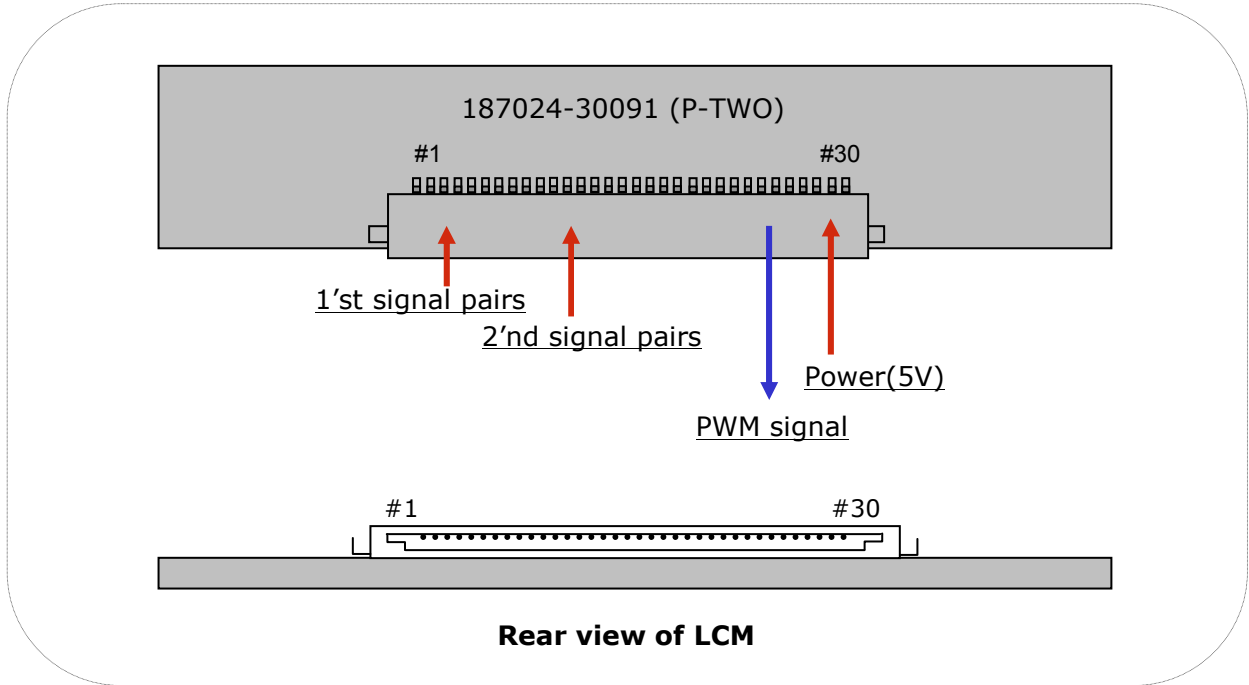

**Note:**

1. NC: No Connection.
2. All GND(ground) pins should be connected together and to Vss which should also be connected to the LCD's metal frame.
3. All V<sub>LCD</sub> (power input) pins should be connected together.
4. Input Level of LVDS signal is based on the IEA 664 Standard.
5. PWM\_OUT is a reference signal for inverter control.  
This PWM signal is synchronized with vertical frequency.  
Its frequency is 3 times of vertical frequency, and its duty ratio is 50%.  
If the system don't use this pin, do not connect.

**Product Specification**

The backlight interface connector is a model 35001HS-02LD manufactured by YEONHO. The mating connector part number are 35001WR-02L(2pin) or equivalent. The pin configuration for the connector is shown in the table below.

**Table 5. Backlight connector pin configuration(CN2,CN3)**

Pin	Symbol	Description	Notes
1	HV	High Voltage for Lamp	1
2	LV	Low Voltage for Lamp	2

Notes: 1. The high voltage power terminal is colored gray.  
2. The low voltage pin color is black.

**FIG. 5 Backlight connector diagram**

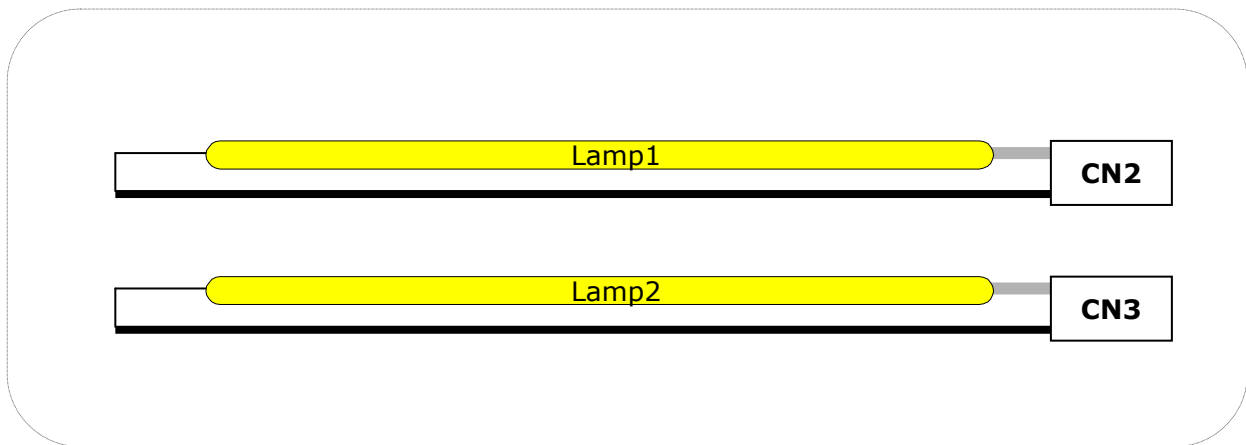

**Product Specification**

**3-3. LVDS characteristics**

**3-3-1. DC Specification**

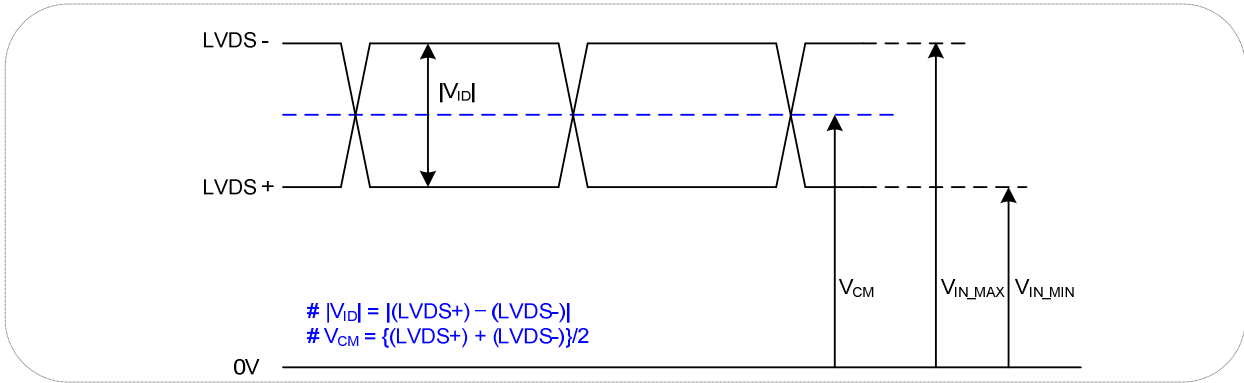

Description	Symbol	Min	Max	Unit	Notes
LVDS Differential Voltage	$ V_{ID} $	200	600	mV	-
LVDS Common mode Voltage	$V_{CM}$	0.6	1.8	V	-
LVDS Input Voltage Range	$V_{IN}$	0.3	2.1	V	-

**3-3-2. AC Specification**

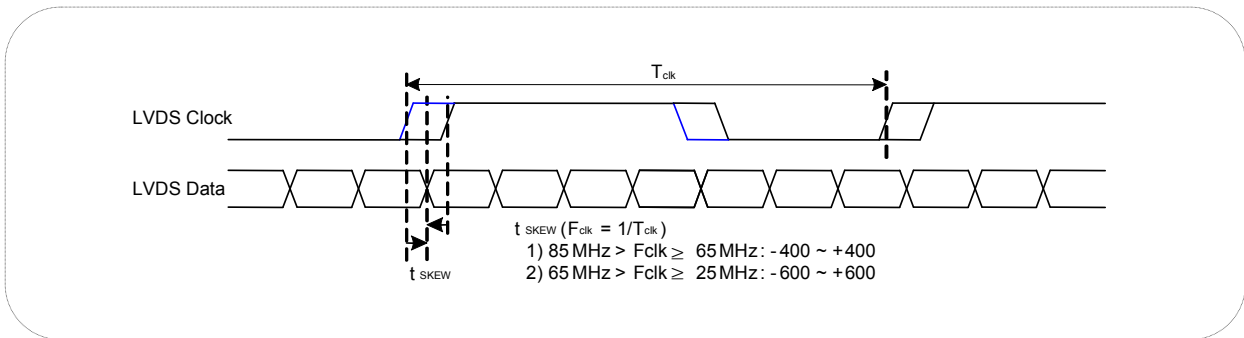

Description	Symbol	Min	Max	Unit	Notes
LVDS Clock to Data Skew Margin	$t_{SKEW}$	- 400	+ 400	ps	85MHz > Fclk ≥ 65MHz
	$t_{SKEW}$	- 600	+ 600	ps	65MHz > Fclk ≥ 25MHz
LVDS Clock to Clock Skew Margin (Even to Odd)	$t_{SKEW\_EO}$	- 1/7	+ 1/7	$T_{clk}$	-
Maximum deviation of input clock frequency during SSC	$F_{DEV}$	-	± 3	%	-
Maximum modulation frequency of input clock during SSC	$F_{MOD}$	-	200	KHz	-

**Product Specification**

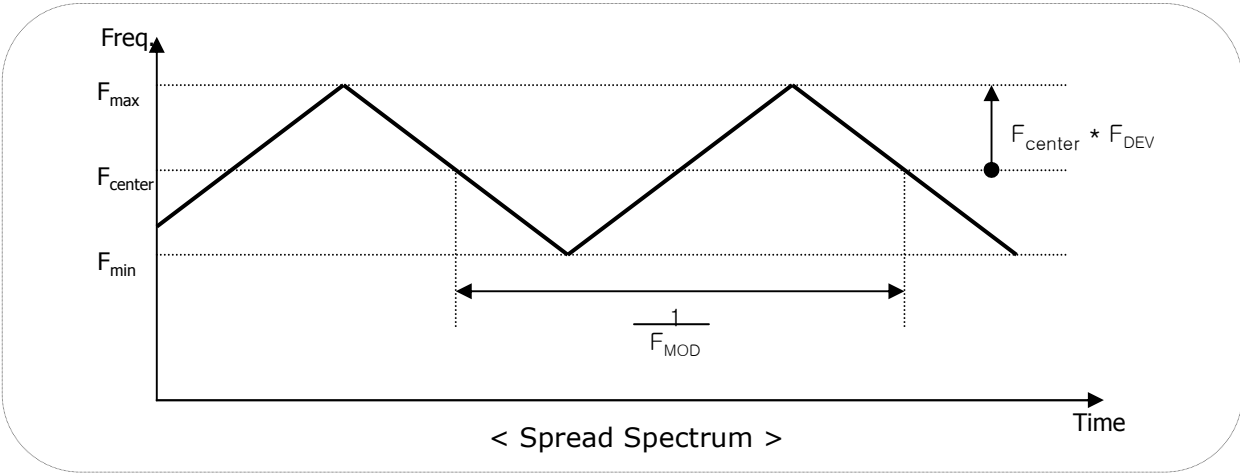
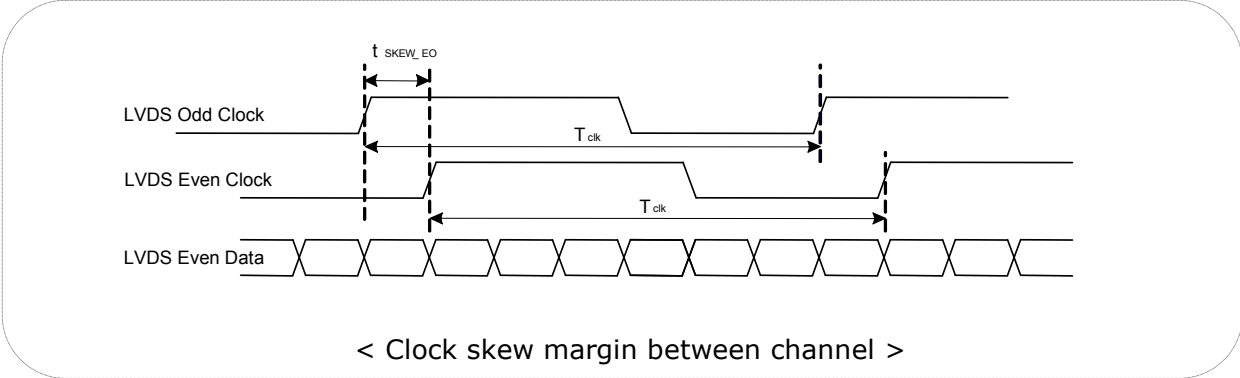

3-3-3. LVDS Data format

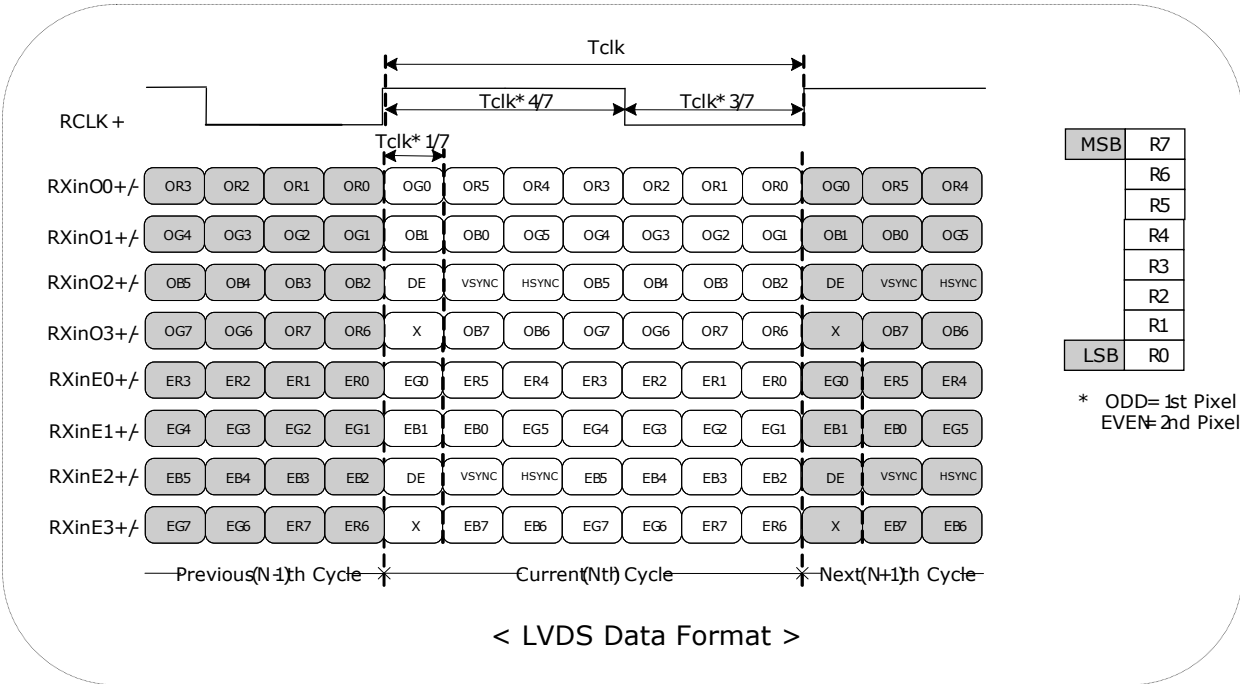

**Product Specification**
**Table 6. Required signal assignment for Flat Link(NS:DS90CF383) transmitter**

Pin #	Pin Name	Require Signal	Pin #	Pin Name	Require Signal
1	VCC	Power Supply for TTL Input	29	GND	Ground pin for TTL
2	D5	TTL Input (R7)	30	D26	TTL Input (DE)
3	D6	TTL Input (R5)	31	T <sub>x</sub> CLKIN	TTL Level clock Input
4	D7	TTL Input (G0)	32	PWR DWN	Power Down Input
5	GND	Ground pin for TTL	33	PLL GND	Ground pin for PLL
6	D8	TTL Input (G1)	34	PLL VCC	Power Supply for PLL
7	D9	TTL Input (G2)	35	PLL GND	Ground pin for PLL
8	D10	TTL Input (G6)	36	LVDS GND	Ground pin for LVDS
9	VCC	Power Supply for TTL Input	37	TxOUT3+	Positive LVDS differential data output 3
10	D11	TTL Input (G7)	38	TxOUT3-	Negative LVDS differential data output 3
11	D12	TTL Input (G3)	39	T <sub>x</sub> CLKOUT+	Positive LVDS differential clock output
12	D13	TTL Input (G4)	40	T <sub>x</sub> CLKOUT-	Negative LVDS differential clock output
13	GND	Ground pin for TTL	41	T <sub>x</sub> OUT2+	Positive LVDS differential data output 2
14	D14	TTL Input (G5)	42	T <sub>x</sub> OUT2-	Negative LVDS differential data output 2
15	D15	TTL Input (B0)	43	LVDS GND	Ground pin for LVDS
16	D16	TTL Input (B6)	44	LVDS VCC	Power Supply for LVDS
17	VCC	Power Supply for TTL Input	45	T <sub>x</sub> OUT1+	Positive LVDS differential data output 1
18	D17	TTL Input (B7)	46	T <sub>x</sub> OUT1-	Negative LVDS differential data output 1
19	D18	TTL Input (B1)	47	T <sub>x</sub> OUT0+	Positive LVDS differential data output 0
20	D19	TTL Input (B2)	48	T <sub>x</sub> OUT0-	Negative LVDS differential data output 0
21	GND	Ground pin for TTL Input	49	LVDS GND	Ground pin for LVDS
22	D20	TTL Input (B3)	50	D27	TTL Input (R6)
23	D21	TTL Input (B4)	51	D0	TTL Input (R0)
24	D22	TTL Input (B5)	52	D1	TTL Input (R1)
25	D23	TTL Input (RSVD)	53	GND	Ground pin for TTL
26	VCC	Power Supply for TTL Input	54	D2	TTL Input (R2)
27	D24	TTL Input (HSYNC)	55	D3	TTL Input (R3)
28	D25	TTL Input (VSYNC)	56	D4	TTL Input (R4)

Notes : Refer to LVDS Transmitter Data Sheet for detail descriptions.

## Product Specification

### 3-4. Signal timing specifications

This is the signal timing required at the input of the User connector. All of the interface signal timing should be satisfied with the following specifications for its proper operation.

**Table 7. Timing table**

Parameter		Symbol	Min.	Typ.	Max.	Unit	Notes
D <sub>CLK</sub>	Period	t <sub>CLK</sub>	18.4	23.4	28.0	ns	Pixel frequency : Typ.85.8MHz (2pixel / clk)
	Frequency	f <sub>CLK</sub>	35.7	42.9	54.4	MHz	
Horizontal	Horizontal Valid	t <sub>HV</sub>	683	683	683	t <sub>CLK</sub>	
	H Period Total	t <sub>HP</sub>	723	896	1023		
	Hsync Frequency	f <sub>H</sub>	39.9	47.9	60.6		
Vertical	Vertical Valid	t <sub>VV</sub>	768	768	768	t <sub>HP</sub>	
	V Period Total	t <sub>VP</sub>	776	798	1108		
	Vsync Frequency	f <sub>V</sub>	50	60	76		
DE (Data Enable)	DE Setup Time	t <sub>SI</sub>	4	-	-	ns	For D <sub>CLK</sub>
	DE Hold Time	t <sub>HI</sub>	4	-	-		
Data	Data Setup Time	t <sub>SD</sub>	4	-	-	ns	For D <sub>CLK</sub>
	Data Hold Time	t <sub>HD</sub>	4	-	-		

**Note:**

1. LM185WH1-TLA1 is DE Only mode operation. The input of Hsync & Vsync signal does not have an effect on LCD normal operation.
2. The performance of the electro-optical characteristics may be influenced by variance of the vertical refresh rates.
3. Horizontal period should be even.



**Product Specification**

**3-5. Signal timing waveforms**

1. DCLK, DE, DATA waveforms

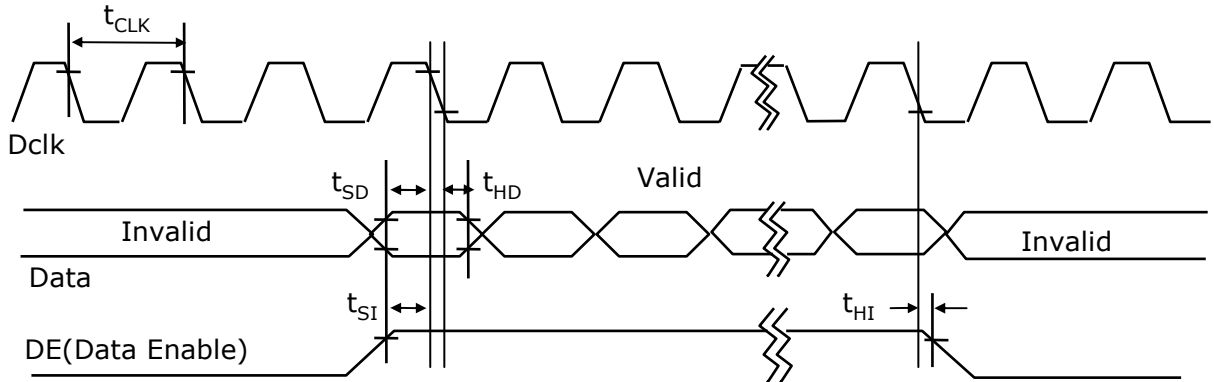

2. Horizontal waveform

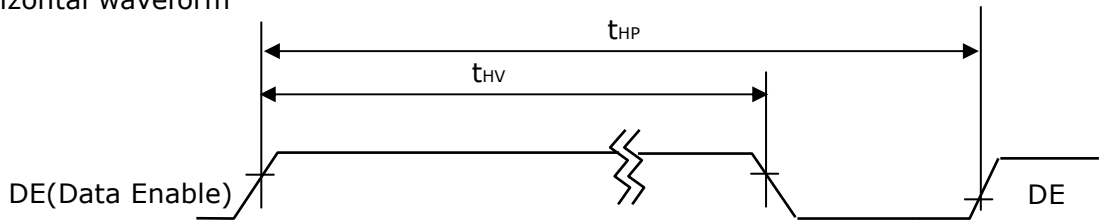

3. Vertical waveform

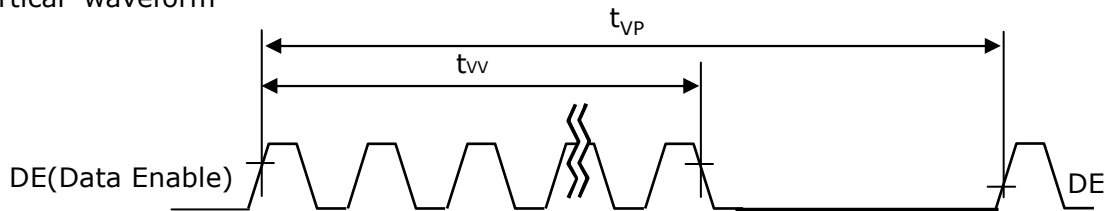

**Product Specification**

**3-6. Color input data reference**

The brightness of each primary color (red, green and blue) is based on the 8bit gray scale data input for the color ; the higher the binary input, the brighter the color. The table below provides a reference for color versus data input.

**Table 8. Color data reference**

Color		Input Color Data																							
		Red								Green								Blue							
		MSB				LSB				MSB				LSB				MSB				LSB			
		R7	R6	R5	R4	R3	R2	R1	R0	G7	G6	G5	G4	G3	G2	G1	G0	B7	B6	B5	B4	B3	B2	B1	B0
Basic Color	Black	0	0	0	0	0	0	0	0	0	0	0	0	0	0	0	0	0	0	0	0	0	0	0	0
	Red (255)	1	1	1	1	1	1	1	1	0	0	0	0	0	0	0	0	0	0	0	0	0	0	0	0
	Green (255)	0	0	0	0	0	0	0	0	1	1	1	1	1	1	1	1	0	0	0	0	0	0	0	0
	Blue (255)	0	0	0	0	0	0	0	0	0	0	0	0	0	0	0	0	1	1	1	1	1	1	1	1
	Cyan	0	0	0	0	0	0	0	0	1	1	1	1	1	1	1	1	1	1	1	1	1	1	1	1
	Magenta	1	1	1	1	1	1	1	1	0	0	0	0	0	0	0	0	1	1	1	1	1	1	1	1
	Yellow	1	1	1	1	1	1	1	1	1	1	1	1	1	1	1	1	0	0	0	0	0	0	0	0
	White	1	1	1	1	1	1	1	1	1	1	1	1	1	1	1	1	1	1	1	1	1	1	1	1
Red	Red(000) Dark	0	0	0	0	0	0	0	0	0	0	0	0	0	0	0	0	0	0	0	0	0	0	0	0
	Red(001)	0	0	0	0	0	0	0	1	0	0	0	0	0	0	0	0	0	0	0	0	0	0	0	0
	Red(002)	0	0	0	0	0	0	1	0	0	0	0	0	0	0	0	0	0	0	0	0	0	0	0	0
	-----	-	-	-	-	-	-	-	-	-	-	-	-	-	-	-	-	-	-	-	-	-	-	-	-
	-----	-	-	-	-	-	-	-	-	-	-	-	-	-	-	-	-	-	-	-	-	-	-	-	-
	Red(253)	1	1	1	1	1	1	0	1	0	0	0	0	0	0	0	0	0	0	0	0	0	0	0	0
	Red(254)	1	1	1	1	1	1	1	0	0	0	0	0	0	0	0	0	0	0	0	0	0	0	0	0
	Red(255) Bright	1	1	1	1	1	1	1	1	0	0	0	0	0	0	0	0	0	0	0	0	0	0	0	0
Green	Green(000) Dark	0	0	0	0	0	0	0	0	0	0	0	0	0	0	0	0	0	0	0	0	0	0	0	0
	Green(001)	0	0	0	0	0	0	0	0	0	0	0	0	0	0	1	0	0	0	0	0	0	0	0	0
	Green(002)	0	0	0	0	0	0	0	0	0	0	0	0	0	1	0	0	0	0	0	0	0	0	0	0
	-----	-	-	-	-	-	-	-	-	-	-	-	-	-	-	-	-	-	-	-	-	-	-	-	-
	-----	-	-	-	-	-	-	-	-	-	-	-	-	-	-	-	-	-	-	-	-	-	-	-	-
	Green(253)	0	0	0	0	0	0	0	1	1	1	1	1	1	1	0	1	0	0	0	0	0	0	0	0
	Green(254)	0	0	0	0	0	0	0	1	1	1	1	1	1	1	1	0	0	0	0	0	0	0	0	0
	Green(255) Bright	0	0	0	0	0	0	0	1	1	1	1	1	1	1	1	1	0	0	0	0	0	0	0	0
Blue	Blue(000) Dark	0	0	0	0	0	0	0	0	0	0	0	0	0	0	0	0	0	0	0	0	0	0	0	0
	Blue(001)	0	0	0	0	0	0	0	0	0	0	0	0	0	0	0	0	0	0	0	0	0	0	0	1
	Blue(002)	0	0	0	0	0	0	0	0	0	0	0	0	0	0	0	0	0	0	0	0	0	0	1	0
	-----	-	-	-	-	-	-	-	-	-	-	-	-	-	-	-	-	-	-	-	-	-	-	-	-
	-----	-	-	-	-	-	-	-	-	-	-	-	-	-	-	-	-	-	-	-	-	-	-	-	-
	Blue(253)	0	0	0	0	0	0	0	0	0	0	0	0	0	0	0	1	1	1	1	1	1	1	0	1
	Blue(254)	0	0	0	0	0	0	0	0	0	0	0	0	0	0	0	1	1	1	1	1	1	1	1	0
	Blue(255) Bright	0	0	0	0	0	0	0	0	0	0	0	0	0	0	0	1	1	1	1	1	1	1	1	1

**Product Specification**

**3-7. Power sequence**

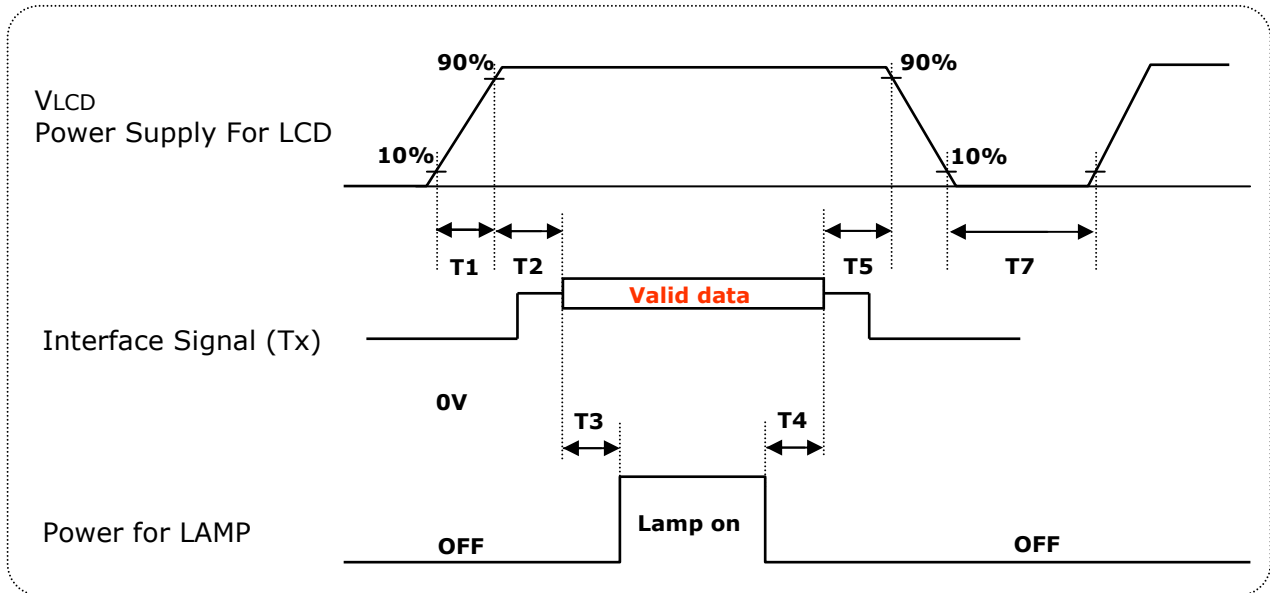

**Table 9. Power sequence**

Parameter	Values			Units
	Min	Typ	Max	
T1	0.5	-	10	ms
T2	0.01	-	50	ms
T3	500	-	-	ms
T4	200	-	-	ms
T5	0.01	-	50	ms
T7	1	-	-	s

Notes :

1. Please avoid floating state of interface signal at invalid period.
2. When the interface signal is invalid, be sure to pull down the power supply for LCD  $V_{LCD}$  to 0V.
3. Lamp power must be turn on after power supply for LCD an interface signal are valid.

**Product Specification**

**3-8.  $V_{LCD}$  Power dip condition**

**FIG. 6 Power dip condition**

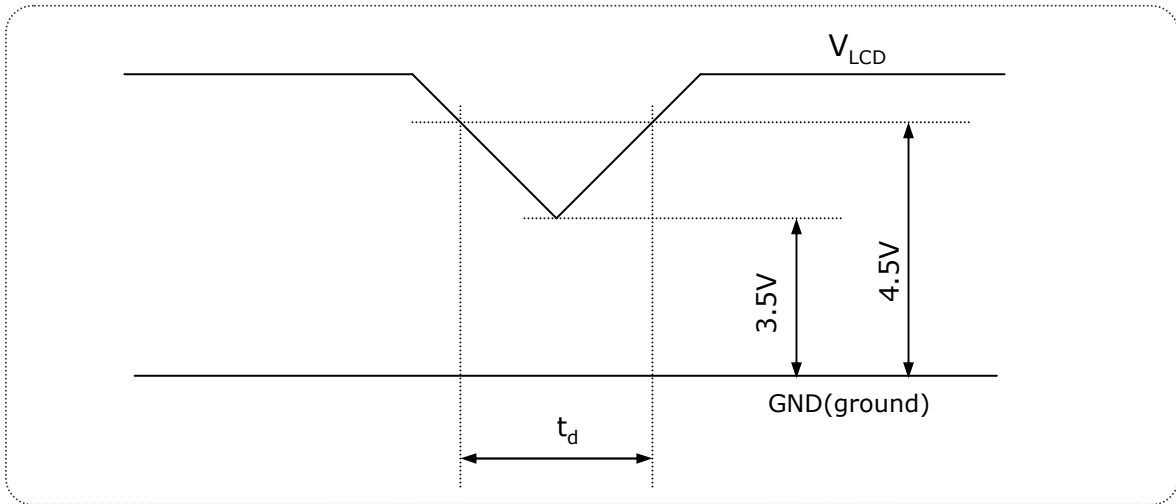

1) Dip condition

$$3.5V \leq V_{LCD} < 4.5V, t_d \leq 20ms$$

2)  $V_{LCD} < 3.5V$

$V_{LCD}$ -dip conditions should also follow the Power On/Off conditions for supply voltage.

**Product Specification**

**4. Optical specification**

Optical characteristics are determined after the unit has been 'ON' for 30 minutes in a dark environment at 25°C. The values specified are at an approximate distance 50cm from the LCD surface at a viewing angle of  $\phi$  and  $\theta$  equal to 0°.

FIG. 7 presents additional information concerning the measurement equipment and method.

**FIG. 7 Optical characteristic measurement equipment and method**

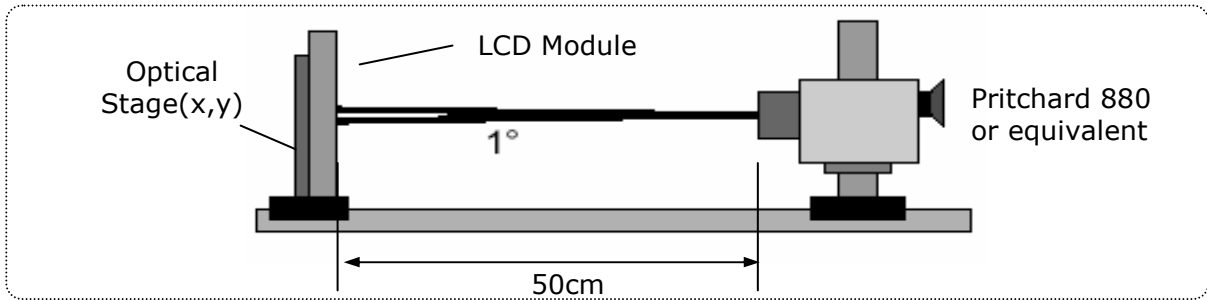

**Table 10. Optical characteristics**

Ta= 25°C, V<sub>LCD</sub>=5.0V, fV=60Hz f<sub>CLK</sub>= 42.9MHz, IBL=7.5mA

Parameter	Symbol	Values			Units	Notes	
		Min	Typ	Max			
Contrast Ratio	CR	600	1000	-		1	
Surface Luminance, white	L <sub>WH</sub>	250	300	-	cd/m <sup>2</sup>	2	
Luminance Variation	$\delta_{\text{WHITE}}$ 9P	75			%	3	
Response Time	Rise Time	Tr <sub>R</sub>	1.1	2.6	ms	4	
	Decay Time	Tr <sub>D</sub>	3.9	7.4	ms	4	
Color Coordinates [CIE1931]	RED	Rx	Typ -0.03	0.642	Typ +0.03		
		Ry		0.334			
	GREEN	Gx		0.304			
		Gy		0.608			
	BLUE	Bx		0.146			
		By		0.073			
	WHITE	Wx		0.313			
		Wy		0.329			
Viewing Angle (CR>5)							
	x axis, right( $\phi=0^\circ$ )	$\theta_r$	75	88		Degree	5
	x axis, left ( $\phi=180^\circ$ )	$\theta_l$	75	88			
	y axis, up ( $\phi=90^\circ$ )	$\theta_u$	70	85			
	y axis, down ( $\phi=270^\circ$ )	$\theta_d$	70	85			
Viewing Angle (CR>10)							
	x axis, right( $\phi=0^\circ$ )	$\theta_r$	70	85		Degree	5
	x axis, left ( $\phi=180^\circ$ )	$\theta_l$	70	85			
	y axis, up ( $\phi=90^\circ$ )	$\theta_u$	60	75			
	y axis, down ( $\phi=270^\circ$ )	$\theta_d$	70	85			
Crosstalk				1.5	%		
Luminance uniformity - Angular dependence (TCO'03)	LR	-	-	1.7		6	
Color grayscale linearity	$\Delta u'v'$		0.018			8	

**Product Specification**

Notes :

1. Contrast ratio(CR) is defined mathematically as :It is measured at center point(1)

$$\text{Contrast ratio} = \frac{\text{Surface luminance with all white pixels}}{\text{Surface luminance with all black pixels}}$$

2. Surface luminance is the luminance value at center 1 point(1) across the LCD surface 50cm from the surface with all pixels displaying white. For more information see FIG 8.

3. The variation in surface luminance ,  $\delta_{\text{WHITE}}$  is defined as

$$\delta_{\text{WHITE}} = \frac{\text{Minimum (P1,P2 .....P9)}}{\text{Maximum (P1,P2 .....P9)}} * 100$$

For more information see Figure 8.

**FIG. 8 Luminance measuring point**

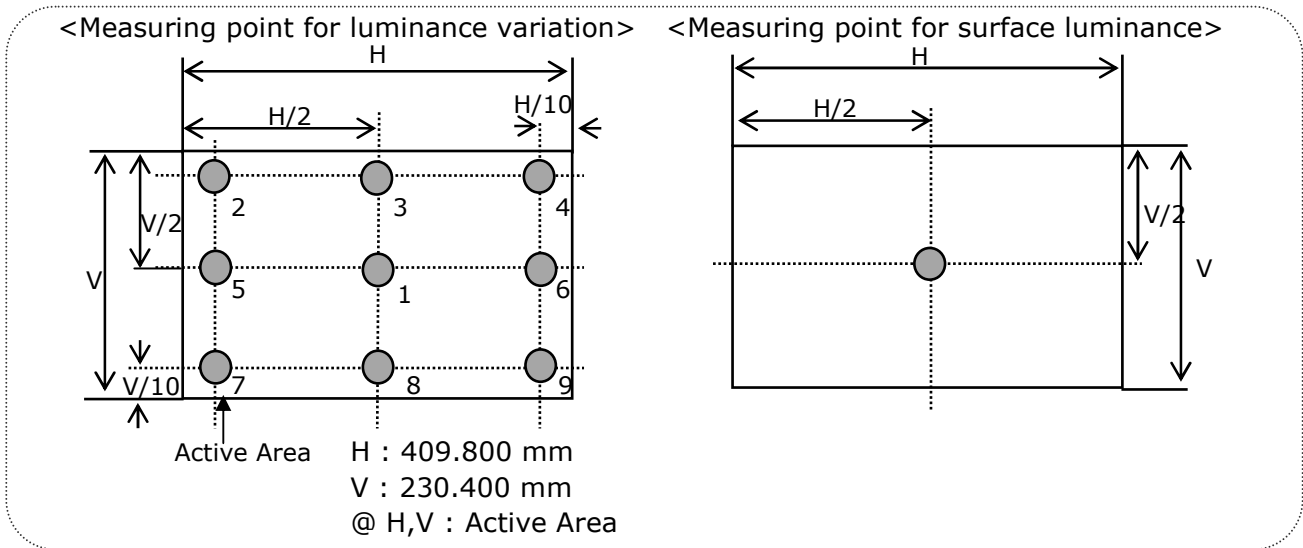



**Product Specification**

Notes :

**6. Luminance Uniformity - angular – dependence (LR& TB)**

TCO '03 Luminance uniformity – angular dependence, is the capacity of the VDU to present the same Luminance level independently of the viewing direction. The angular-dependent luminance uniformity is calculated as the ratio of maximum luminance to minimum luminance in the specified measurement areas.

- Test pattern : 80% white pattern
- Test point : 2-point
- Test distance :  $D * 1.5 = 70.52\text{cm}$
- Test method :  $L_R = ((L_{\text{max.}+30\text{deg.}} / L_{\text{min.}+30\text{deg.}}) + (L_{\text{max.}-30\text{deg.}} / L_{\text{min.}-30\text{deg.}})) / 2$   
 $T_B = ((L_{\text{max.}+15\text{deg.}} / L_{\text{min.}+15\text{deg.}})$

**FIG. 11 Luminance Uniformity angular dependence**

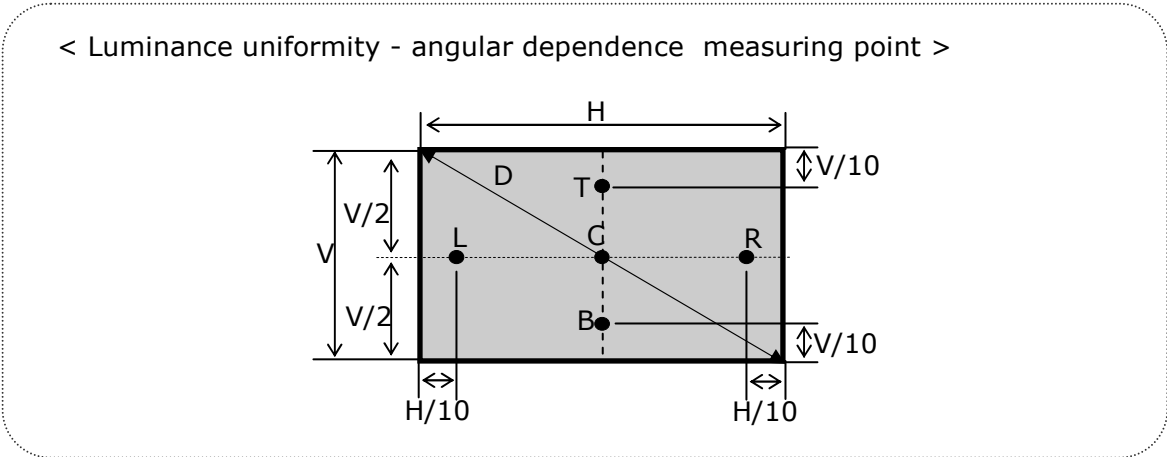

**7. Gray scale specification**

**Table 11. Gray scale**

Gray level	Luminance [%] (Typ)
L0	0.11
L31	1.17
L63	4.80
L95	11.10
L127	20.53
L159	34.44
L191	54.53
L223	78.66
L255	100



**Product Specification**

Notes :

8. Color grayscale linearity ,  $\Delta u'v'$  is defined as

$$\sqrt{(u'_{A} - u'_{B})^2 + (v'_{A} - v'_{B})^2}$$

Where indices A and B are the two gray levels found to have the largest color differences between them.

i.e. get the largest  $\Delta u'$  and  $\Delta v'$  of each 6pairs of  $u'$  and  $v'$  and calculate  $\Delta u'v'$  .

-Test pattern :

100% full white pattern with a test pattern as shown FIG.12  
Squares of 40mm by 40mm in size, filled with 255, 225, 195, 165, 135 and 105 grayscale steps should be arranged in the center of the screen.

-Test method :

First gray step :

Move a square of 255 gray level should be moved into the center of the screen and measure luminance and  $u'$  and  $v'$  coordinates.

Next gray step :

Move a 255 gray square into the center and measure both luminance and  $u'$  and  $v'$  coordinates.

The same procedure shall then be repeated for gray steps 195, 165, 135 and 105.

**FIG. 12 Color grayscale linearity**

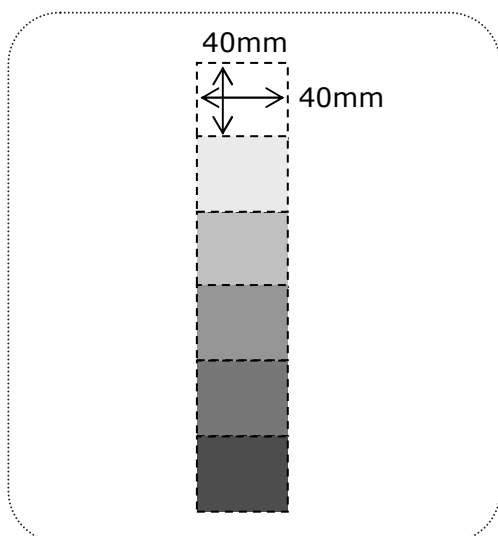

## Product Specification

### 5. Mechanical characteristics

The contents provide general mechanical characteristics. In addition the figures in the next page are detailed mechanical drawing of the LCD.

**Table 12. Mechanical characteristics**

Outline dimension	Horizontal	430.4 mm
	Vertical	254.6 mm
	Depth	13.0 mm
Bezel area	Horizontal	413.4 mm
	Vertical	234.0 mm
Active display area	Horizontal	409.800 mm
	Vertical	230.400 mm
Weight	1550 g (Typ.) 1650 g (Max)	
Surface treatment	Hard coating(3H) Anti-glare treatment of the front polarizer	

Notes : Please refer to a mechanic drawing in terms of tolerance at the next page.

**Product Specification**

**<FRONT VIEW>**

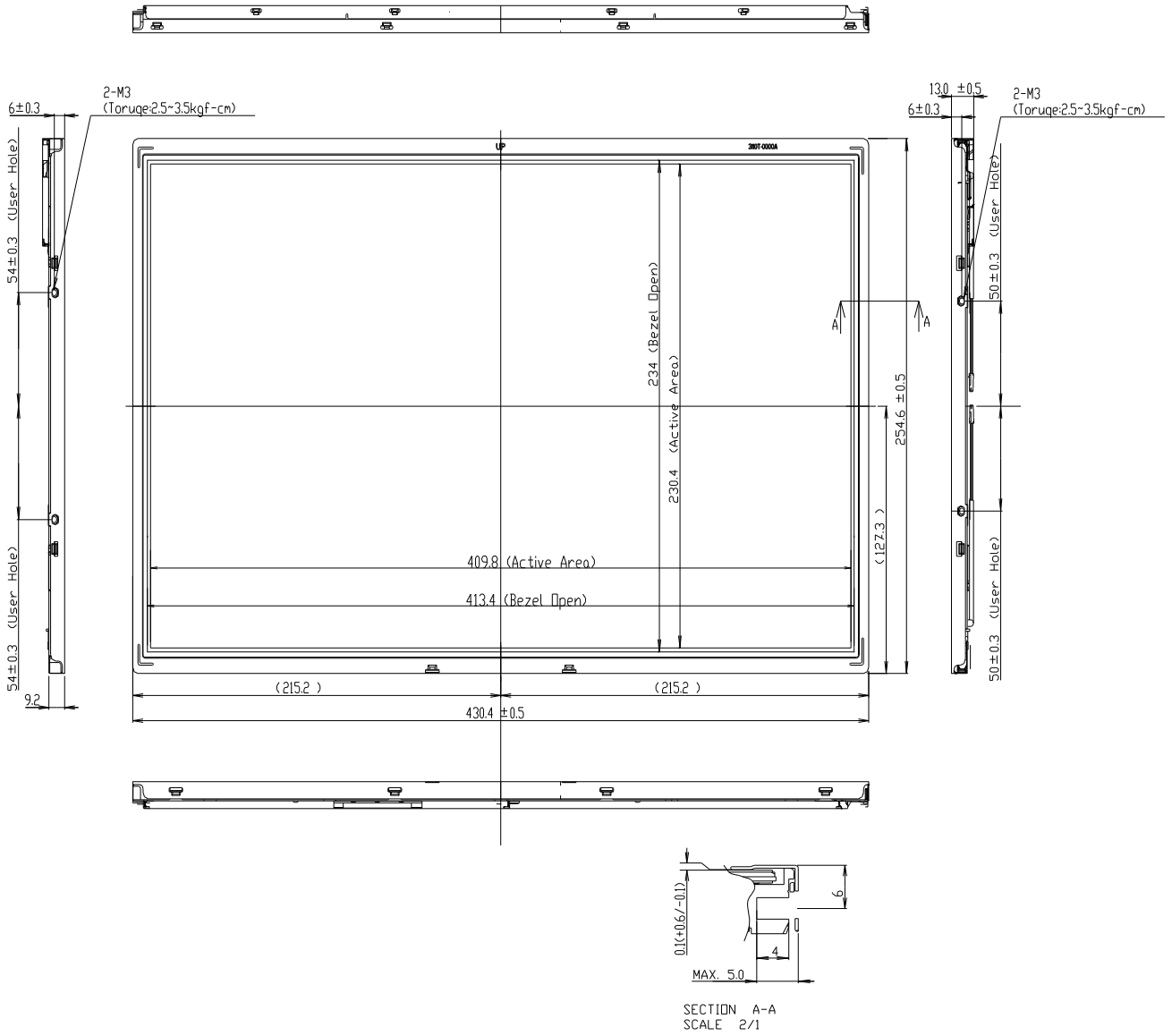

**Product Specification**

**<REAR VIEW>**

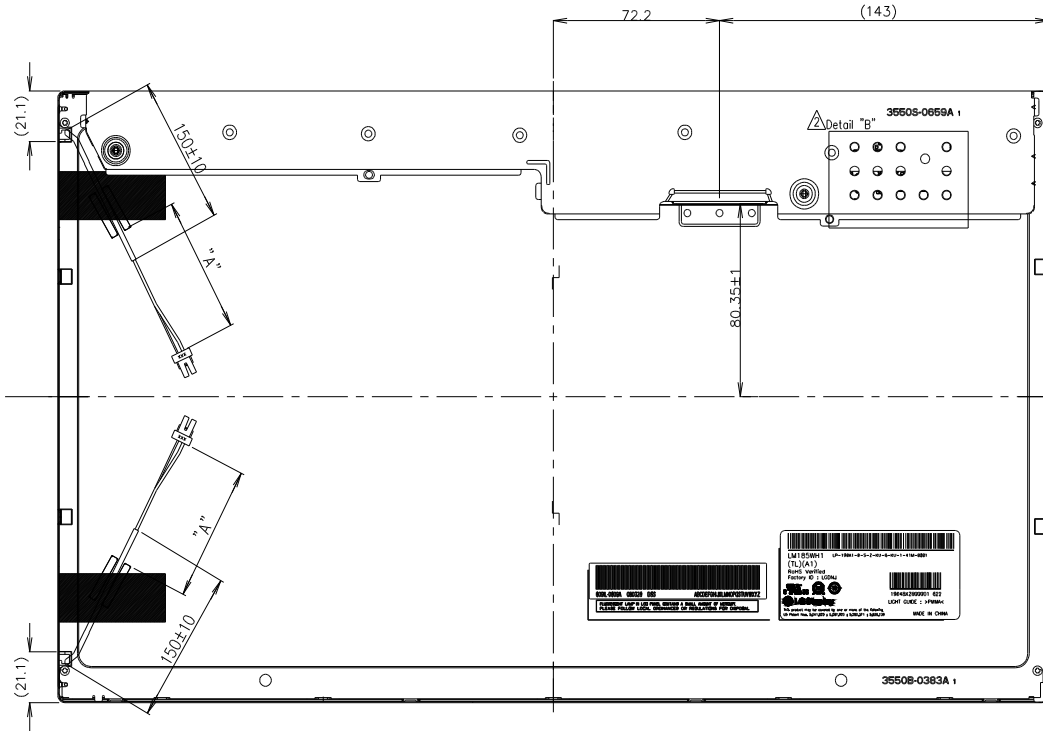

**Notes**

1. Backlight : 2 Cold Cathode Fluorescent Lamps
2. I/F Connector Specification : 187024-30091(P-TWO) or compatible
3. Lamp Connector Specification  
-35001HS-02LD(Yeonho) <2pin>
4. Torque of user hole : 3.0~4.0kgf-cm
5. Tilt and partial disposition tolerance of display area as following
  - (1) Y-Direction : IA-BI <= 1.0
  - (2) X-Direction : IC-DI <= 1.0

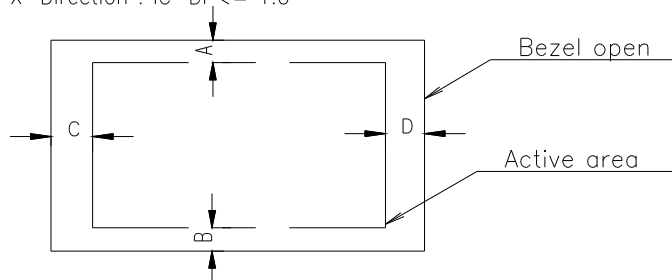

6. Lamp(CCFL) lot No. is marked at backlight connector
7. Do not wind conductive tape around the backlight wires
8. Unspecified tolerances to be  $\pm 0.5\text{mm}$
9. The COF Protecting area is weak & sensitive,  
So, please don't press the COF Protecting area.

**Product Specification**
**6. Reliability**
**Table 13. Environment test conditions**

No	Test Item	Condition
1	High temperature storage test	Ta= 60°C 240hrs
2	Low temperature storage test	Ta= -20°C 240hrs
3	High temperature operation test	Ta= 50°C 50%RH 240hrs
4	Low temperature operation test	Ta= 0°C 240hrs
5	Vibration test (non-operating)	Wave form : random Vibration level : 1.0GRMS Bandwidth : 10-300Hz Duration : X,Y,Z, 30 min One time each direction
6	Shock test (non-operating)	Shock level : 120G Waveform : half sine wave, 2msec Direction : ±X, ±Y, ±Z One time each direction
7	Altitude operating storage / shipment	0 - 10,000 feet(3,048m) 0 - 40,000 feet(12,192m)

{ Result evaluation criteria }

There should be no change which might affect the practical display function when the display quality test is conducted under normal operating condition.

**Product Specification****7. International standards****7-1. Safety**

- a) UL 60950-1:2003, First Edition, Underwriters Laboratories, Inc.,  
Standard for Safety of Information Technology Equipment.
- b) CAN/CSA C22.2, No. 60950-1-03 1st Ed. April 1, 2003, Canadian Standards Association,  
Standard for Safety of Information Technology Equipment.
- c) EN 60950-1:2001, First Edition,  
European Committee for Electro-technical Standardization(CENELEC)  
European Standard for Safety of Information Technology Equipment.
- d) RoHS, Directive 2002/95/EC of the European Parliament and of the council of 27  
January 2003

**7-2. EMC**

- a) ANSI C63.4 "Methods of Measurement of Radio-Noise Emissions from Low-Voltage  
Electrical and Electrical Equipment in the Range of 9kHz to 40GHz. "American National  
Standards Institute(ANSI),1992
- b) C.I.S.P.R "Limits and Methods of Measurement of Radio Interface Characteristics of  
Information Technology Equipment." International Special Committee on Radio  
Interference.
- c) EN 55022 "Limits and Methods of Measurement of Radio Interface Characteristics of  
Information Technology Equipment." European Committee for Electro-technical  
Standardization.(CENELEC), 1998 ( Including A1: 2000 )

**Product Specification**

**8. Packing**

**8-1. Designation of lot mark**

a) Lot mark

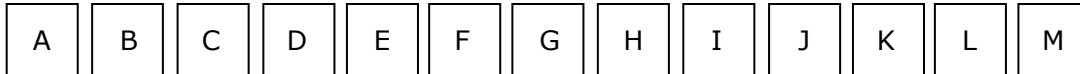

A,B,C : Size (Inch)  
E : Month

D : Year  
F ~ M : Serial No.

Note:

1. Year

Year	2001	2002	2003	2004	2005	2006	2007	2008	2009	2010
Mark	1	2	3	4	5	6	7	8	9	0

2. Month

Month	Jan	Feb	Mar	Apr	May	Jun	Jul	Aug	Sep	Oct	Nov	Dec
Mark	1	2	3	4	5	6	7	8	9	A	B	C

b) Location of lot mark

Serial No. is printed on the label. The label is attached to the backside of the LCD module. This is subject to change without prior notice.

**8-2. Packing form**

- a) Package quantity in one box : 10 pcs
- b) Box size : 540 mm X 312 mm X 315 mm

**Product Specification****9. Precautions**

Please pay attention to the followings when you use this TFT LCD module.

**9-1. Mounting Precautions**

- (1) You must mount a module using holes arranged in four corners or four sides.
- (2) You should consider the mounting structure so that uneven force (ex. Twisted stress) is not applied to the Module. And the case on which a module is mounted should have sufficient strength so that external force is not transmitted directly to the module.
- (3) Please attach the surface transparent protective plate to the surface in order to protect the polarizer. Transparent protective plate should have sufficient strength in order to the resist external force.
- (4) You should adopt radiation structure to satisfy the temperature specification.
- (5) Acetic acid type and chlorine type materials for the cover case are not desirable because the former generates corrosive gas of attacking the polarizer at high temperature and the latter causes circuit break by electro-chemical reaction.
- (6) Do not touch, push or rub the exposed polarizers with glass, tweezers or anything harder than HB pencil lead. And please do not rub with dust clothes with chemical treatment. Do not touch the surface of polarizer for bare hand or greasy cloth. (Some cosmetics are detrimental to the polarizer.)
- (7) When the surface becomes dusty, please wipe gently with absorbent cotton or other soft materials like chamois soaks with petroleum benzene. Normal-hexane is recommended for cleaning the adhesives used to attach front / rear polarizers. Do not use acetone, toluene and alcohol because they cause chemical damage to the polarizer.
- (8) Wipe off saliva or water drops as soon as possible. Their long time contact with polarizer causes deformations and color fading.
- (9) Do not open the case because inside circuits do not have sufficient strength.

**9-2. Operating precautions**

- (1) The spike noise causes the mis-operation of circuits. It should be lower than following voltage :  $V = \pm 200\text{mV}$  (Over and under shoot voltage)
- (2) Response time depends on the temperature. (In lower temperature, it becomes longer.)
- (3) Brightness depends on the temperature. (In lower temperature, it becomes lower.) And in lower temperature, response time (required time that brightness is stable after turned on) becomes longer.
- (4) Be careful for condensation at sudden temperature change. Condensation makes damage to polarizer or electrical contacted parts. And after fading condensation, smear or spot will occur.
- (5) When fixed patterns are displayed for a long time, remnant image is likely to occur.
- (6) Module has high frequency circuits. Sufficient suppression to the electromagnetic interference shall be done by system manufacturers. Grounding and shielding methods may be important to minimized the interference.
- (7) Please do not give any mechanical and/or acoustical impact to LCM. Otherwise, LCM can not be operated its full characteristics perfectly.
- (8) A screw which is fastened up the steels should be a machine screw (if not, it causes metal foreign material and deal LCM a fatal blow)
- (9) Please do not set LCD on its edge.



## Product Specification

### 9-3. Electrostatic discharge control

Since a module is composed of electronic circuits, it is not strong to electrostatic discharge. Make certain that treatment persons are connected to ground through wrist band etc. And don't touch interface pin directly.

### 9-4. Precautions for strong light exposure

Strong light exposure causes degradation of polarizer and color filter.

### 9-5. Storage

When storing modules as spares for a long time, the following precautions are necessary.

- (1) Store them in a dark place. Do not expose the module to sunlight or fluorescent light. Keep the temperature between 5°C and 35°C at normal humidity.
- (2) The polarizer surface should not come in contact with any other object.  
It is recommended that they be stored in the container in which they were shipped.

### 9-6. Handling precautions for protection film

- (1) The protection film is attached to the bezel with a small masking tape.  
When the protection film is peeled off, static electricity is generated between the film and polarizer. This should be peeled off slowly and carefully by people who are electrically grounded and with well ion-blown equipment or in such a condition, etc.
- (2) When the module with protection film attached is stored for a long time, sometimes there remains a very small amount of glue still on the bezel after the protection film is peeled off.
- (3) You can remove the glue easily. When the glue remains on the bezel surface or its vestige is recognized, please wipe them off with absorbent cotton waste or other soft material like chamois soaked with normal-hexane.