

Wideband RF LDMOS Integrated Power Amplifier 40 W, 28 V, 1800 – 2100 MHz

Description

The PTMA180402M is a matched, wideband, 2-stage, 40-watt LDMOS integrated amplifier intended for base station applications in the 1800 to 2100 MHz frequency band. This device is offered in a 20-pin, thermally-enhanced, overmolded plastic package for cool and reliable operation.

PTMA180402M
Package PG-DSO-20-63

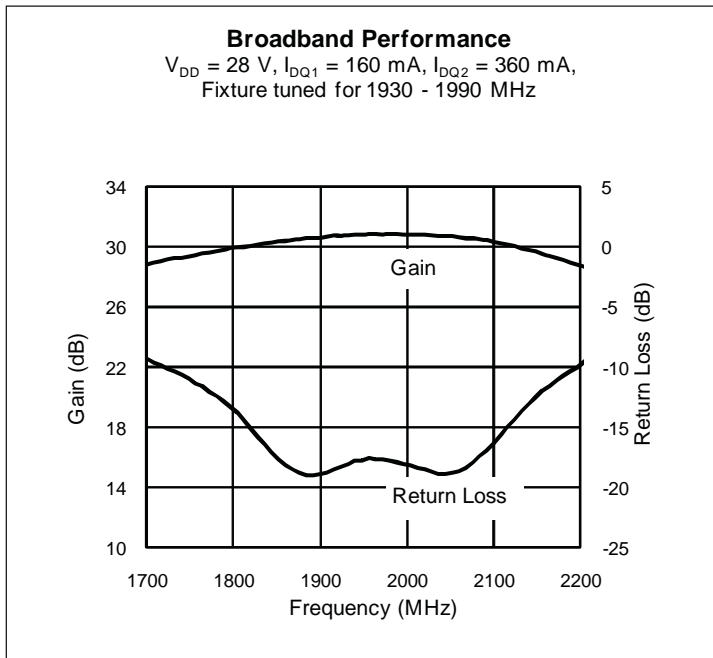

Features

- Designed for wide RF bandwidth and low memory effects
- On-chip matching, integrated input DC block, 50-ohm input and ~4-ohm output
- Typical single-carrier CDMA performance at 1960 MHz, 28 V
 - Average output power = 5 W
 - Linear gain = 30 dB
 - Efficiency = 16%
 - Adjacent channel power = -52 dBc
- Typical two-tone CW performance at 1960 MHz, 28 V
 - Output power (PEP) = 40 W at IMD3 = -30 dBc
 - Efficiency = 34%
- Capable of handling 10:1 VSWR @ 28 V, 40 W (CW) output power
- Integrated ESD protection. Meets HBM Class 1B (minimum), per JESD22-A114F
- Thermally-enhanced, RoHS-compliant package

RF Characteristics

CDMA Measurements (tested in Infineon production test fixture)

$V_{DD} = 28\text{ V}$, $I_{DQ1} = 160\text{ mA}$, $I_{DQ2} = 360\text{ mA}$, $P_{OUT} = 4\text{ W}$ average, $f = 1960\text{ MHz}$, CDMA IS-95, 9 channels

Characteristic	Symbol	Min	Typ	Max	Unit
Gain	G_{ps}	28	30	—	dB
Drain Efficiency	η_D	14	16	—	%
Adjacent Channel Power Ratio	ACPR	—	-52	-50	dBc

RF Characteristics continued next page

All published data at $T_{CASE} = 25^\circ\text{C}$ unless otherwise indicated

ESD: Electrostatic discharge sensitive device—observe handling precautions!

RF Characteristics (cont.)

Two-tone Specifications (not subject to production test—verified by design/characterization in Infineon test fixture)
 $V_{DD} = 28\text{ V}$, $I_{DQ1} = 160\text{ mA}$, $I_{DQ2} = 360\text{ mA}$, $P_{OUT} = 40\text{ W PEP}$, $f = 1960\text{ MHz}$, tone spacing = 1 MHz

Characteristic	Symbol	Min	Typ	Max	Unit
Gain	G_{ps}	—	30	—	dB
Power Added Efficiency	PAE	—	34	—	%
Third Order Intermodulation Distortion	IMD3	—	-32	—	dBc

DC Characteristics

Stage 1 Characteristics	Conditions	Symbol	Min	Typ	Max	Unit
Drain Leakage Current	$V_{DS} = 28\text{ V}$, $V_{GS} = 0\text{ V}$	I_{DSS}	—	—	1.0	μA
	$V_{DS} = 63\text{ V}$, $V_{GS} = 0\text{ V}$	I_{DSS}	—	—	10.0	μA
Gate Leakage Current	$V_{GS} = 10\text{ V}$, $V_{DS} = 0\text{ V}$	I_{GSS}	—	—	1.0	μA
On-state Resistance	$V_{GS} = 10\text{ V}$, $V_{DS} = 0.1\text{ V}$	$R_{DS(on)}$	—	1.6	—	Ω
Operating Gate Voltage	$V_{DS} = 28\text{ V}$, $I_{DQ1} = 160\text{ mA}$,	V_{GS}	2.0	2.5	3.0	V

Stage 2 Characteristics	Conditions	Symbol	Min	Typ	Max	Unit
Drain-source Breakdown Voltage	$V_{GS} = 0\text{ V}$, $I_{DS} = 10\text{ mA}$	$V_{(BR)DSS}$	65	—	—	V
Drain Leakage Current	$V_{DS} = 28\text{ V}$, $V_{GS} = 0\text{ V}$	I_{DSS}	—	—	1.0	μA
	$V_{DS} = 63\text{ V}$, $V_{GS} = 0\text{ V}$	I_{DSS}	—	—	10.0	μA
Gate Leakage Current	$V_{GS} = 10\text{ V}$, $V_{DS} = 0\text{ V}$	I_{GSS}	—	—	1.0	μA
On-state Resistance	$V_{GS} = 10\text{ V}$, $V_{DS} = 0.1\text{ V}$	$R_{DS(on)}$	—	0.21	—	Ω
Operating Gate Voltage	$V_{DS} = 28\text{ V}$, $I_{DQ2} = 360\text{ mA}$	V_{GS}	2.0	2.5	3.0	V

Maximum Ratings

Parameter	Symbol	Value	Unit
Drain-Source Voltage	V_{DSS}	65	V
Gate-Source Voltage	V_{GS}	-0.5 to +12	V
Junction Temperature	T_J	200	°C
Total Device Dissipation	P_D	175	W
Above 25°C derate by		1.0	W/°C
Storage Temperature Range	T_{STG}	-40 to +150	°C
Overall Thermal Resistance ($T_{CASE} = 70^\circ\text{C}$, 40 W CW)	Stage 1 $R_{\theta JC}$	3.6	°C/W
$P_{OUT} = 40\text{ W}$, $I_{DQ1} = 160\text{ mA}$, $I_{DQ2} = 360\text{ mA}$	Stage 2 $R_{\theta JC}$	1.5	°C/W

Moisture Sensitivity Level

Level	Test Standard	Package Temperature	Unit
3	IPC/JEDEC J-STD-020	260	°C

Ordering Information

Type and Version	Package Outline	Package Description	Shipping
PTMA180402M V1	PG-DSO-20-63	Copper heat slug, plastic EMC body	Tape

Typical Performance, circuit tuned for 2140 MHz (data taken in Infineon test fixture)

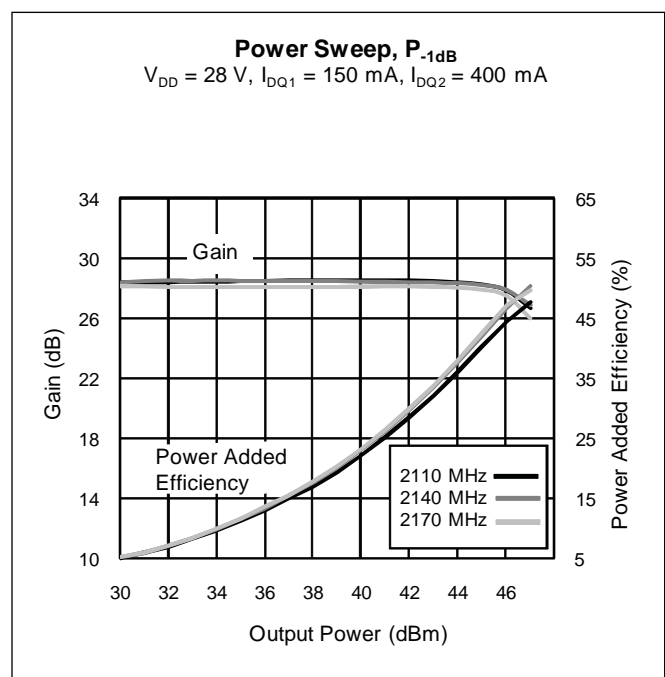
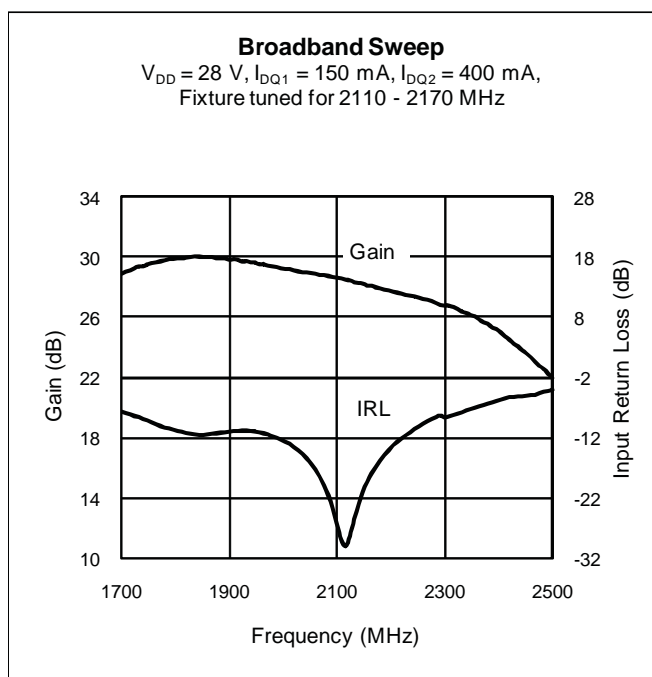

Typical Performance, circuit tuned for 2140 MHz (cont.)

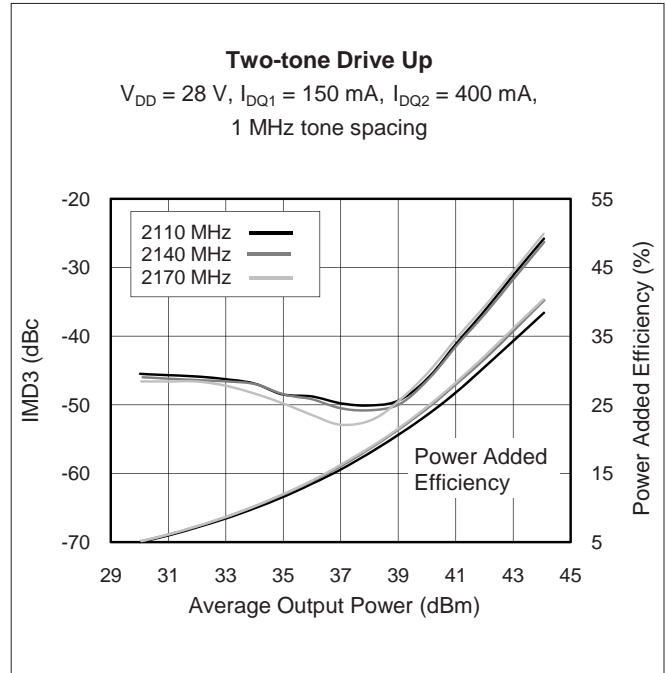
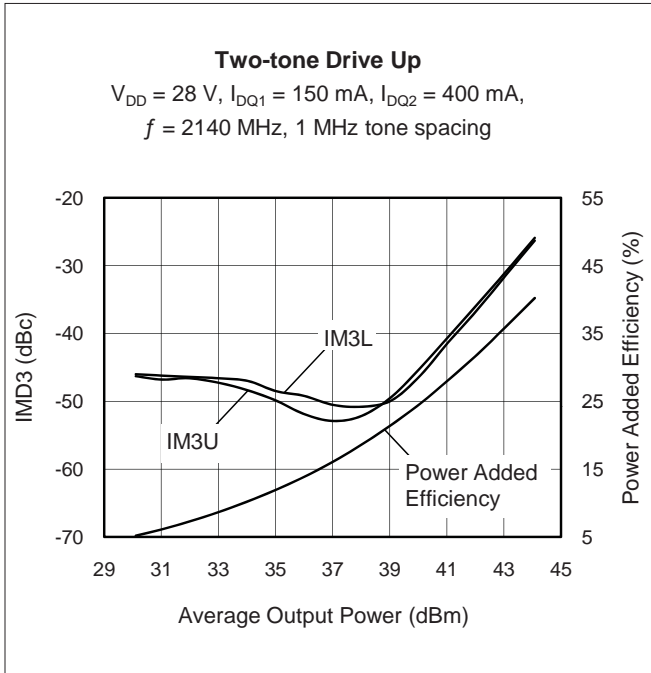

Broadband Circuit Impedance — 2140 MHz

Frequency MHz	Z Load Ω	
	R	jX
1900	5.76	-6.18
1920	5.63	-6.13
1940	5.51	-6.09
1960	5.39	-6.04
1980	5.27	-5.99
2000	5.15	-5.93
2020	5.03	-5.88
2040	4.92	-5.82
2060	4.80	-5.76
2080	4.68	-5.69
2100	4.57	-5.63
2120	4.45	-5.56
2140	4.34	-5.49
2160	4.23	-5.41
2180	4.12	-5.34
2200	4.01	-5.26

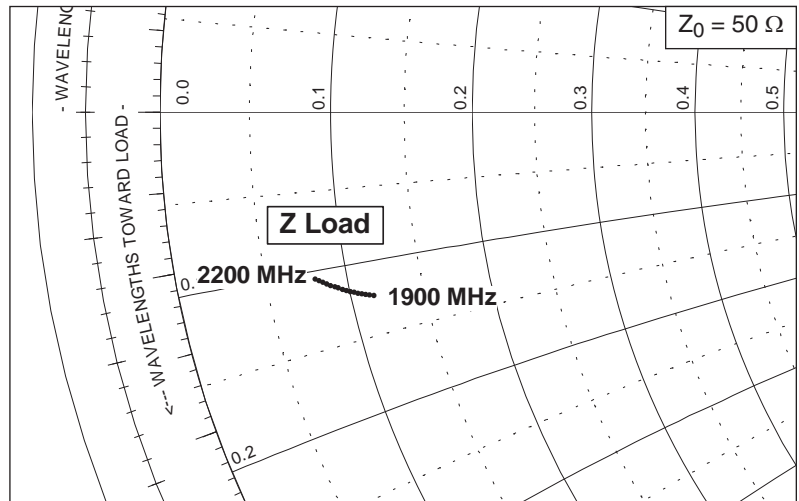
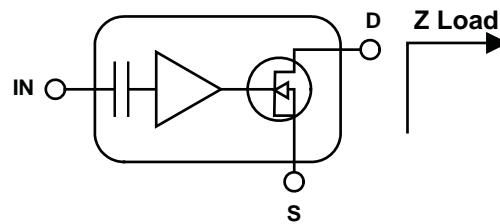

Reference Circuit, tuned for 2140 MHz

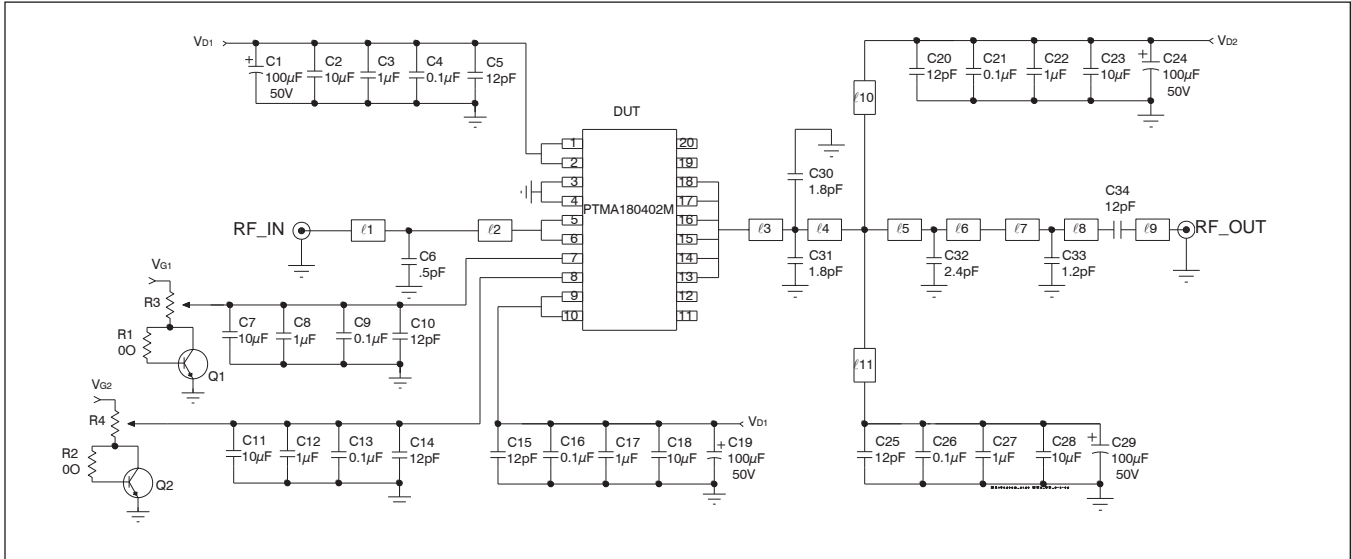

Reference circuit schematic for $f = 2140$ MHz

Circuit Description

DUT	PTMA180402M	LDMOS IC
PCB	Rogers RO4350, 0.76 mm [.030"] thick, $\epsilon_r = 3.48$, 1 oz. copper	
Test fixture part no.	LTN/PTMA180402M	
Find Gerber files for this test fixture on the Infineon Web site at http://www.infineon.com/rfpower		

Circuit Assembly Information

Microstrip	Electrical Characteristics at 2140 MHz	Dimensions: L x W (mm)	Dimensions: L x W (in.)
ℓ1	0.150 λ , 50.0 Ω	12.73 x 1.70	0.501 x 0.067
ℓ2	0.177 λ , 50.0 Ω	15.04 x 1.70	0.592 x 0.067
ℓ3	0.026 λ , 10.4 Ω	2.01 x 13.00	0.079 x 0.512
ℓ4	0.026 λ , 10.4 Ω	2.06 x 13.00	0.081 x 0.512
ℓ5	0.026 λ , 34.2 Ω	2.13 x 3.00	0.084 x 0.118
ℓ6	0.054 λ , 34.2 Ω	4.45 x 3.00	0.175 x 0.118
ℓ7	0.066 λ , 43.5 Ω	5.56 x 2.11	0.219 x 0.083
ℓ8	0.178 λ , 43.5 Ω	14.96 x 2.11	0.589 x 0.083
ℓ9	0.059 λ , 50.0 Ω	5.03 x 1.70	0.198 x 0.067
ℓ10, ℓ11	0.137 λ , 47.8 Ω	11.56 x 1.83	0.455 x 0.072

Reference Circuit — 2140 MHz (cont.)

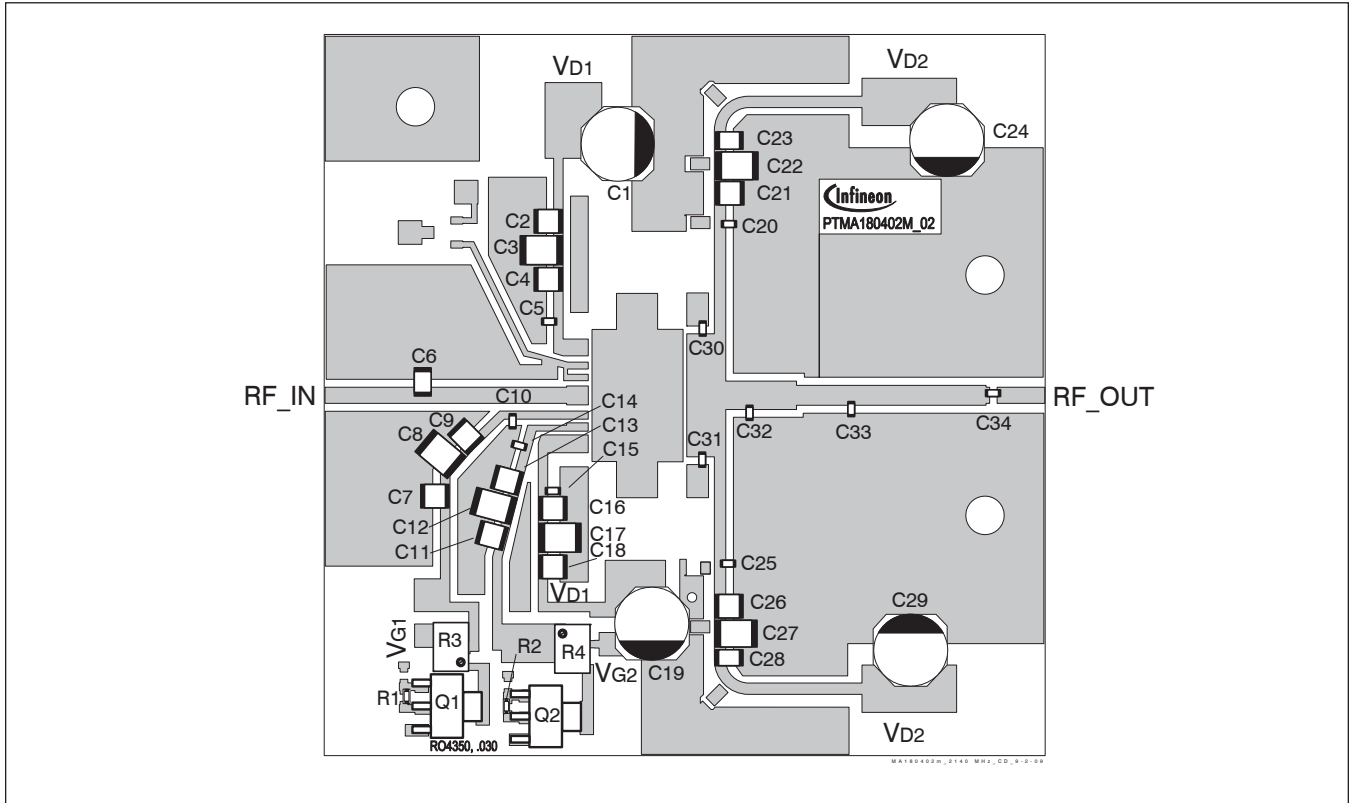

Assembly diagram for 2140 MHz reference circuit (not to scale)

Component	Description	Suggested Manufacturer	P/N or Comment
C1, C19, C24, C29	Electrolytic capacitor, 100 μ F, 50 V	Digi-Key	PCE3718CT-ND
C2, C7, C11, C18, C23, C28	Ceramic capacitor, 10 μ F	Murata	GRM422Y5V106Z050AL
C3, C8, C12, C17, C22, C27	Ceramic capacitor, 1 μ F	Digi-Key	445-1411-2-ND
C4, C9, C13, C16, C21, C26	Capacitor, 0.1 μ F	Digi-Key	399-1267-2-ND
C5, C10, C12, C15, C20, C25, C34	Ceramic capacitor, 12 pF	ATC	600S120JT
C6	Ceramic capacitor, 0.5 pF	ATC	100B 0R5
C30, C31	Ceramic capacitor, 1.8 pF	ATC	600S1R8CT
C32	Ceramic capacitor, 2.4 pF	ATC	100B 2R4
C33	Ceramic capacitor, 1.2 pF	ATC	100B 1R2
Q1, Q2	Transistor	Infineon Technologies	BCP56
R1, R2	Resistor, 0 Ω	Digi-Key	603
R3, R4	Potentiometer, 2k Ω	Digi-Key	3224W-202ETR-ND

Typical Performance, circuit tuned for 1960 MHz (data taken in a production test fixture)

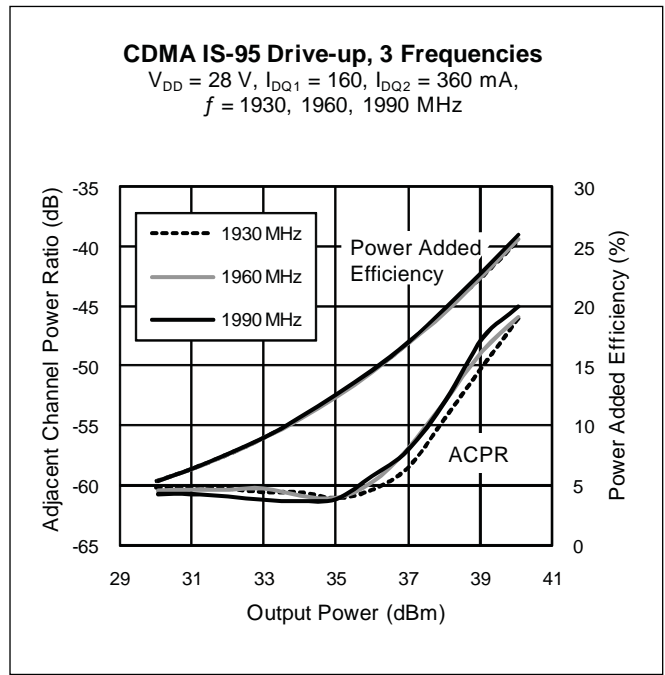
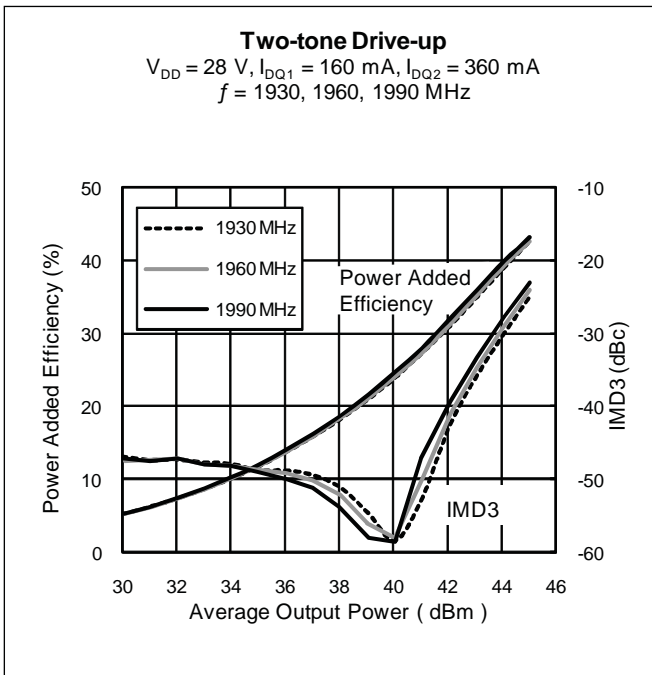
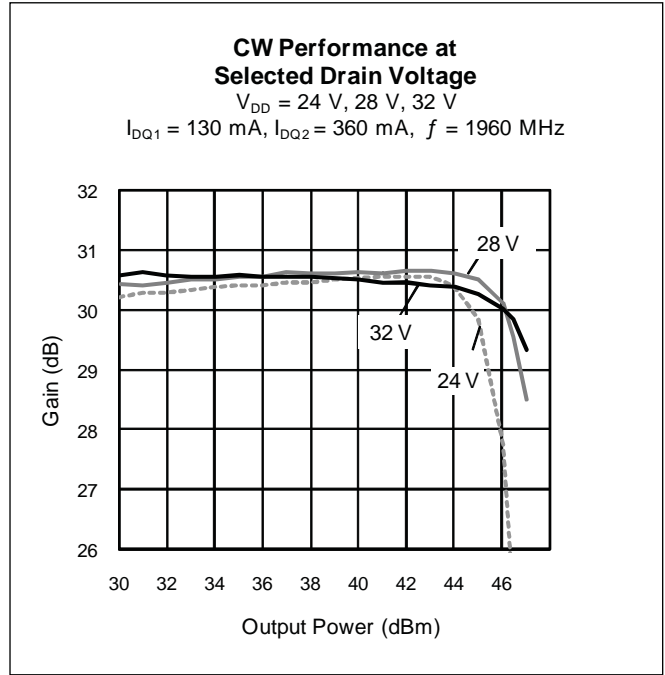
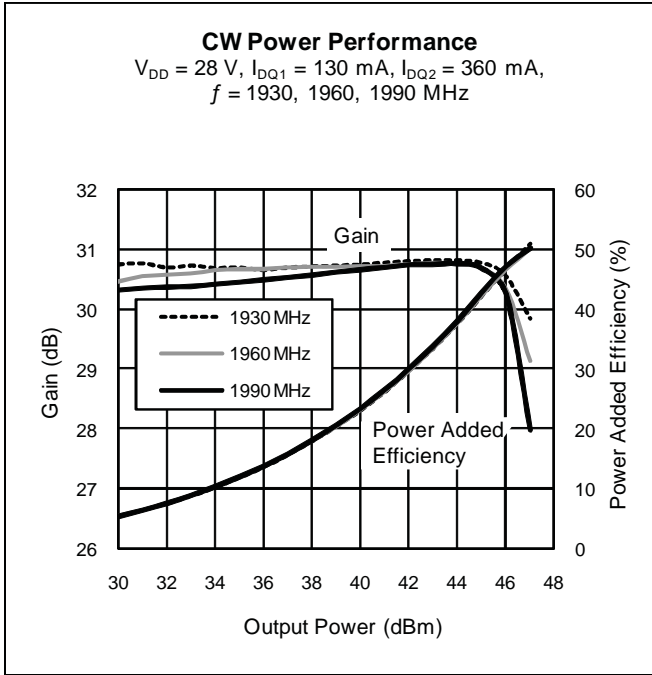

Typical Performance —1960 MHz (cont.)

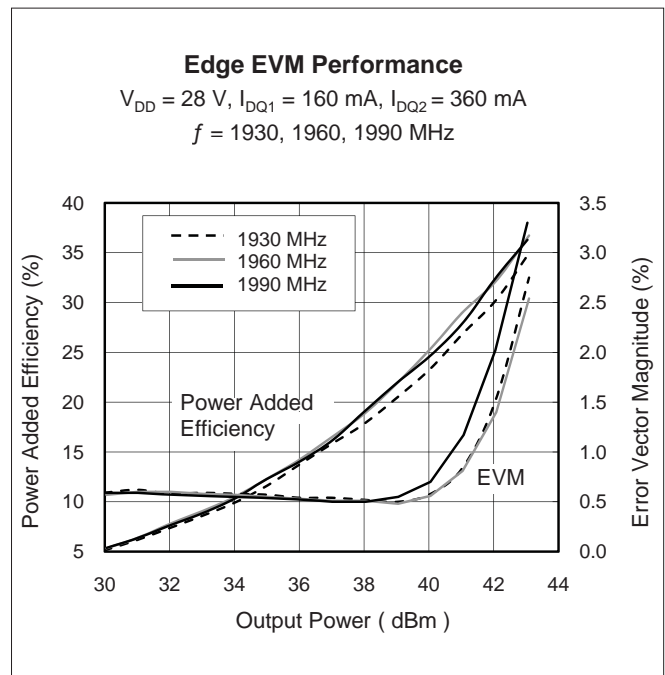
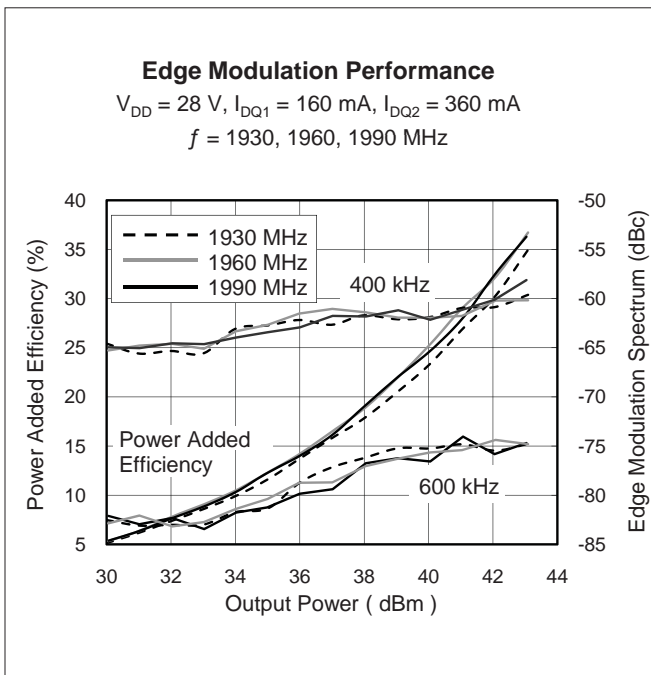
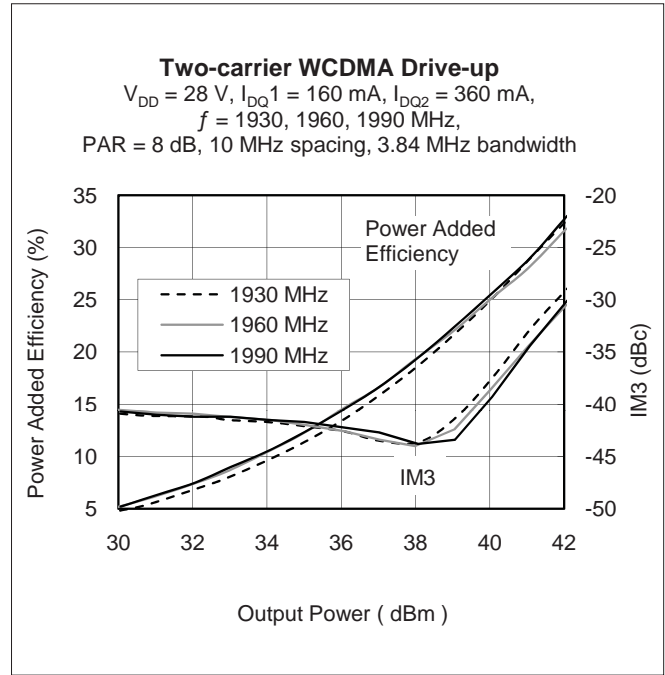
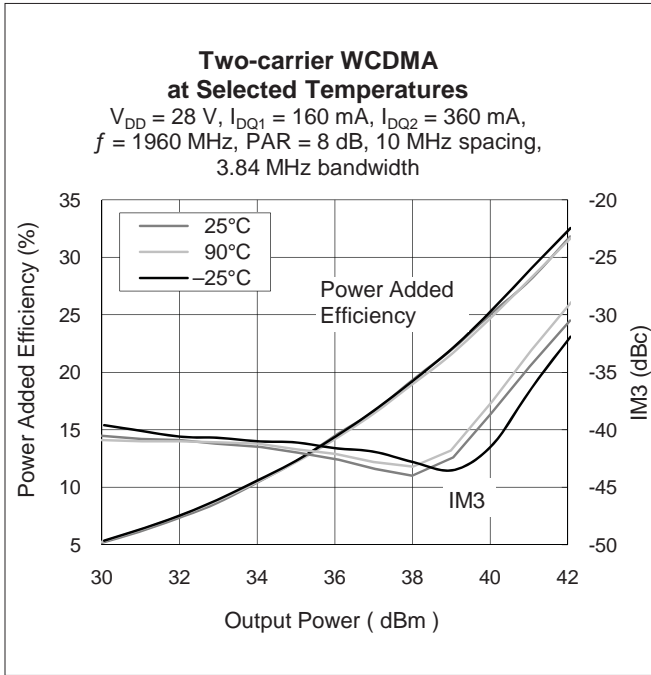

Broadband Circuit Impedance — 1960 MHz

Frequency MHz	Z Load Ω	
	R	jX
1800	5.56	-6.95
1810	5.48	-6.91
1820	5.39	-6.87
1830	5.31	-6.83
1840	5.23	-6.79
1850	5.15	-6.75
1860	5.07	-6.70
1870	4.99	-6.66
1880	4.91	-6.61
1890	4.84	-6.56
1900	4.76	-6.51
1910	4.69	-6.47
1920	4.61	-6.42
1930	4.54	-6.36
1940	4.47	-6.31
1950	4.40	-6.26
1960	4.33	-6.21
1970	4.26	-6.15
1980	4.19	-6.10
1990	4.12	-6.04
2000	4.06	-5.99

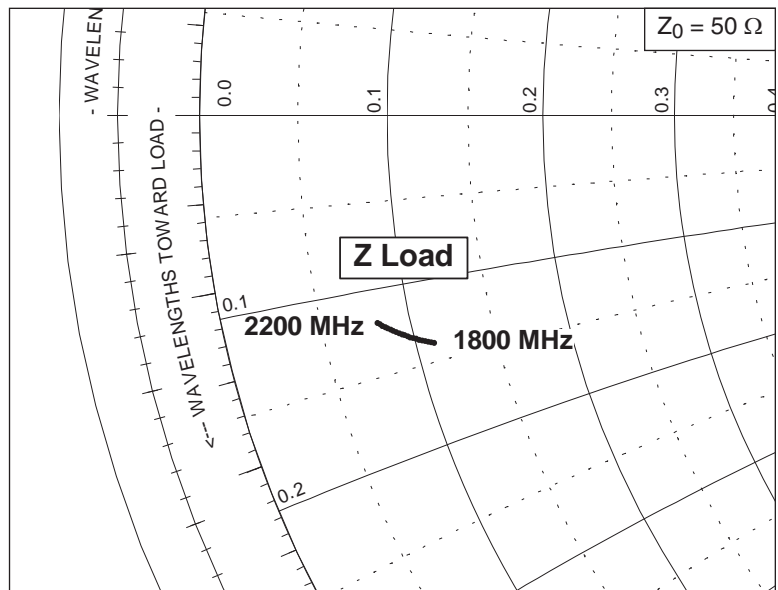
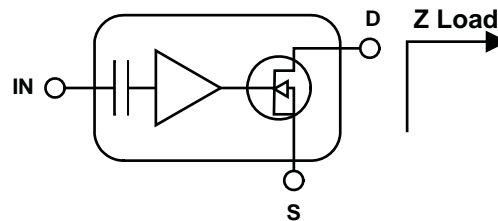

Reference Circuit, tuned for 1960 MHz

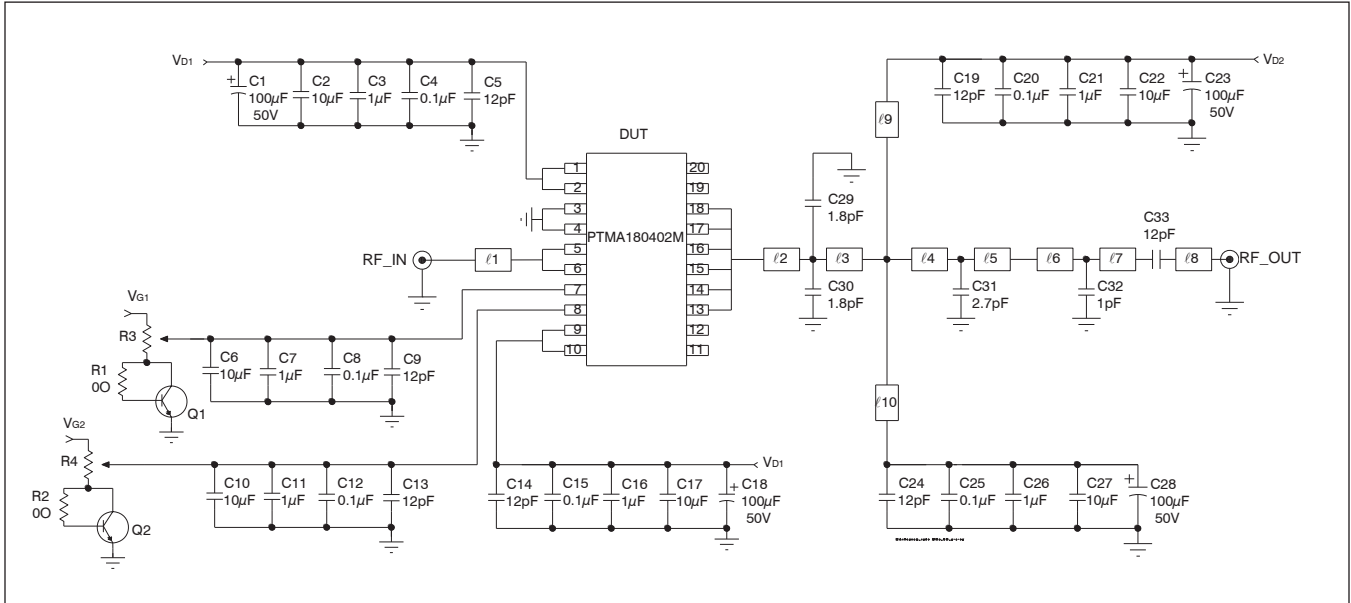

Reference circuit schematic for $f = 1960$ MHz

Circuit Description

DUT	PTMA180402M	LD MOS IC
PCB	Rogers RO4350, 0.76 mm [.030"] thick, $\epsilon_r = 3.48$, 1 oz. copper	
Test Fixture Part No.	LTN/PTMA180402M	
Find Gerber files for this test fixture on the Infineon Web site at http://www.infineon.com/rfpower		

Microstrip	Electrical Characteristics at 1960 MHz	Dimensions: L x W (mm)	Dimensions: L x W (in.)
l1	$0.300 \lambda, 50.0 \Omega$	27.76 x 1.70	1.093 x 0.067
l2	$0.024 \lambda, 10.4 \Omega$	2.01 x 13.00	0.079 x 0.512
l3	$0.024 \lambda, 10.4 \Omega$	2.06 x 13.00	0.081 x 0.512
l4	$0.037 \lambda, 34.2 \Omega$	3.35 x 3.00	0.132 x 0.118
l5	$0.046 \lambda, 34.2 \Omega$	4.11 x 3.00	0.162 x 0.118
l6	$0.097 \lambda, 34.2 \Omega$	8.76 x 3.00	0.345 x 0.118
l7	$0.127 \lambda, 43.6 \Omega$	11.63 x 2.11	0.458 x 0.083
l8	$0.054 \lambda, 50.0 \Omega$	5.03 x 1.70	0.198 x 0.067
l9, l10	$0.125 \lambda, 47.8 \Omega$	11.56 x 1.83	0.455 x 0.072

Reference Circuit — 1960 MHz (cont.)

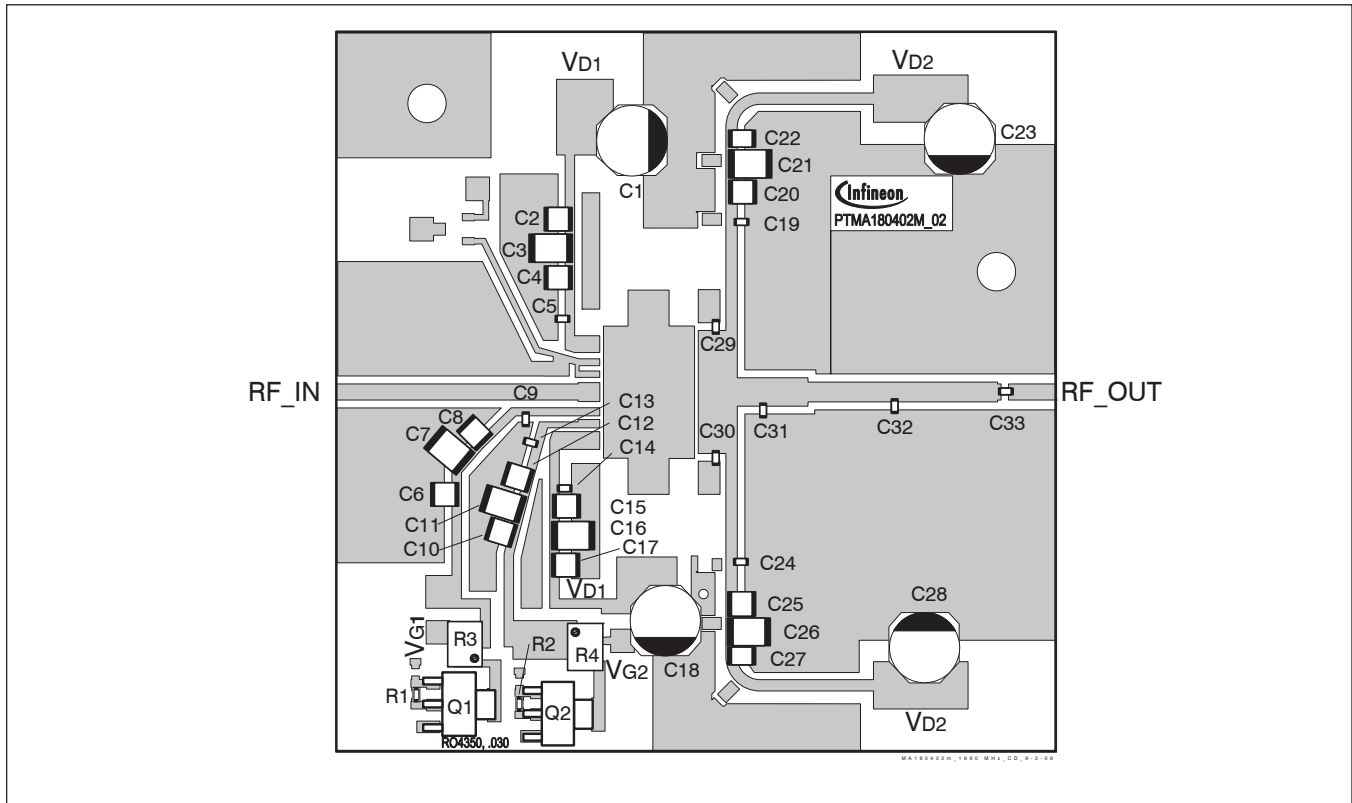

Assembly diagram for 1960 MHz reference circuit (not to scale)

Component	Description	Suggested Manufacturer	P/N or Comment
C1, C18, C23, C28	Electrolytic capacitor, 100 μ F, 50 V	Digi-Key	PCE3718CT-ND
C2, C6, C10, C17, C22, C27	Ceramic capacitor, 10 μ F	Murata	GRM422Y5V106Z050AL
C3, C7, C11, C16, C21, C26	Ceramic capacitor, 1 μ F		Digi-Key 445-1411-2-ND
C4, C8, C12, C15, C20, C25	Capacitor, 0.1 μ F	Digi-Key	399-1267-2-ND
C5, C9, C13, C14, C19, C24, C33	Ceramic capacitor, 12 pF	ATC	600S120JT
C29, C30, C31	Ceramic capacitor, 1.8 pF	ATC	600S1R8CT
C32	Ceramic capacitor, 1.0 pF	ATC	100B 1R0
Q1, Q2	Transistor	Infineon Technologies	BCP56
R1, R2	Resistor, 0 Ω	Digi-Key	603
R3, R4	Potentiometer, 2k Ω	Digi-Key	3224W-202ETR-ND

Pinout Diagram

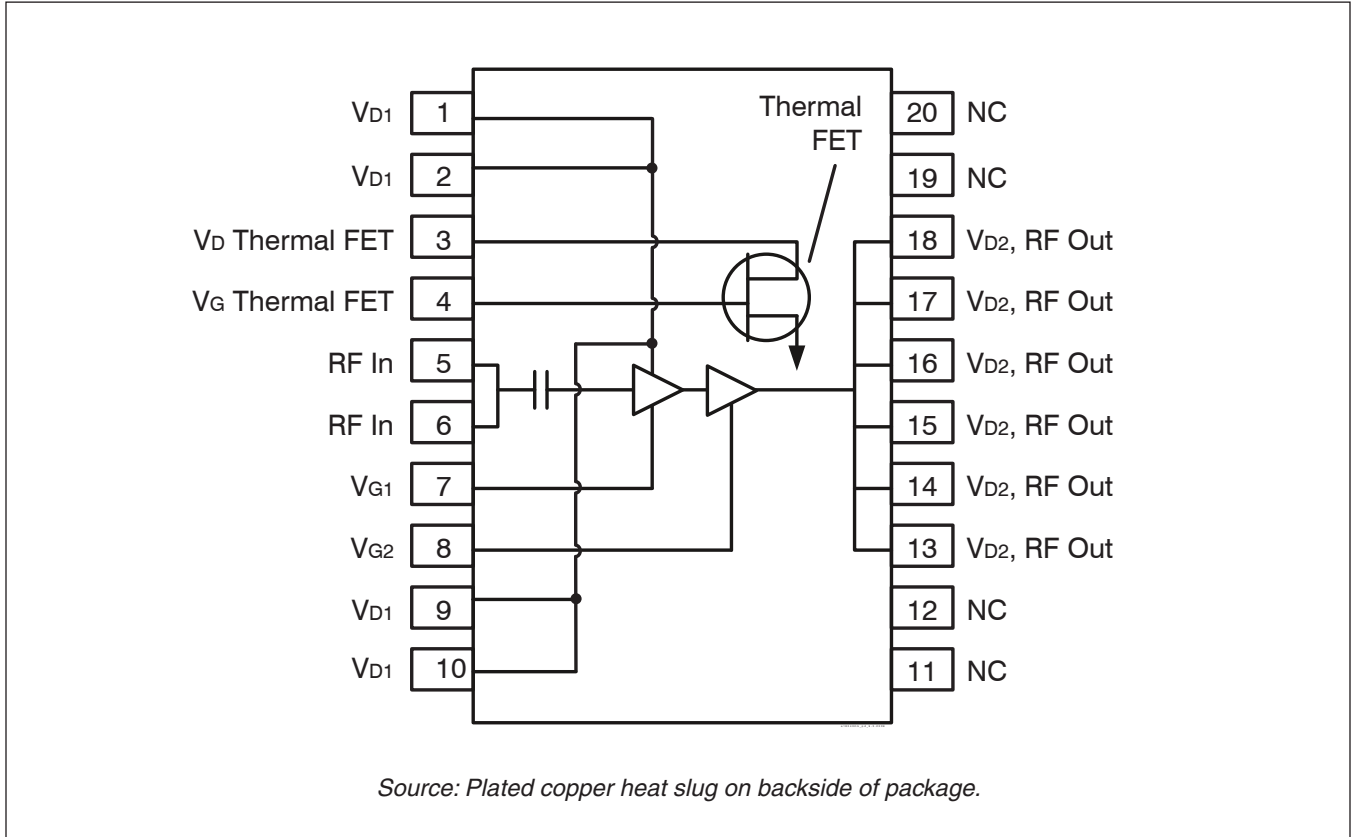

Package Outline Specifications

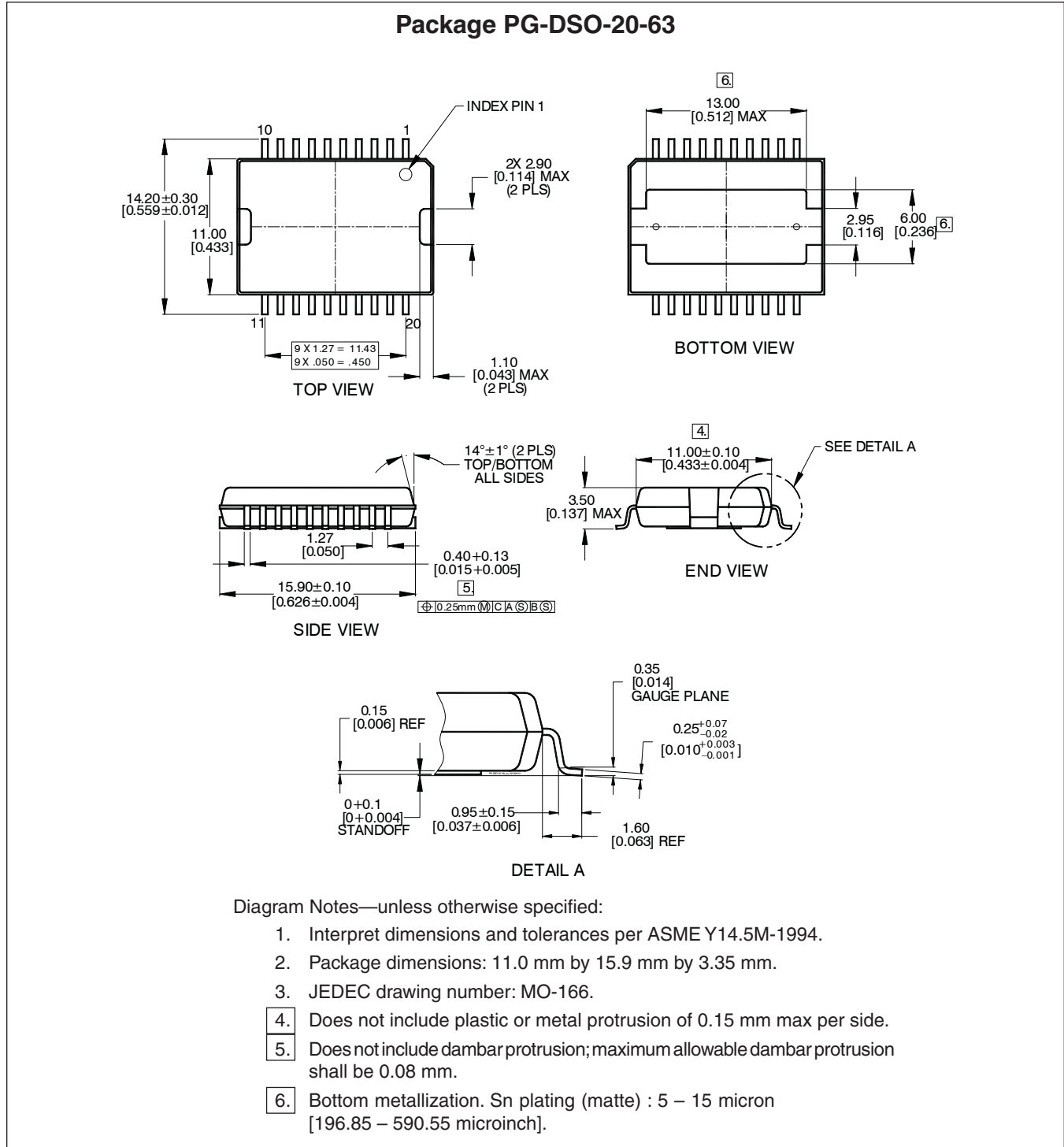

Refer to Application Note "Recommendations for Printed Circuit Board Assembly of Infineon DSO and SSOP Packages" for additional information.

Page	Subjects (major changes since last revision)
1	Revisions to RF characteristics.
2	Changes to $V_{(BR)DSS}$ and $R_{DS(on)}$, DC table
3, 11	Corrected typos.
9	Removed voltage vs. temperature graph.
all	Miscellaneous cosmetic adjustments.

We Listen to Your Comments

Any information within this document that you feel is wrong, unclear or missing at all?
Your feedback will help us to continuously improve the quality of this document.
Please send your proposal (including a reference to this document) to:

highpowerRF@infineon.com

To request other information, contact us at:
+1 877 465 3667 (1-877-GO-LDMOS) USA
or +1 408 776 0600 International

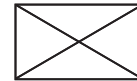

Edition 2011-08-10

Published by
Infineon Technologies AG
81726 Munich, Germany

© 2008 Infineon Technologies AG
All Rights Reserved.

Legal Disclaimer

The information given in this document shall in no event be regarded as a guarantee of conditions or characteristics. With respect to any examples or hints given herein, any typical values stated herein and/or any information regarding the application of the device, Infineon Technologies hereby disclaims any and all warranties and liabilities of any kind, including without limitation, warranties of non-infringement of intellectual property rights of any third party.

Information

For further information on technology, delivery terms and conditions and prices, please contact the nearest Infineon Technologies Office (www.infineon.com/rfpower).

Warnings

Due to technical requirements, components may contain dangerous substances. For information on the types in question, please contact the nearest Infineon Technologies Office.

Infineon Technologies components may be used in life-support devices or systems only with the express written approval of Infineon Technologies, if a failure of such components can reasonably be expected to cause the failure of that life-support device or system or to affect the safety or effectiveness of that device or system. Life support devices or systems are intended to be implanted in the human body or to support and/or maintain and sustain and/or protect human life. If they fail, it is reasonable to assume that the health of the user or other persons may be endangered.