

T-1^{3/4} (5 mm), T-1 (3 mm) Blue LED Lamps

Technical Data

Features

- Popular T-1^{3/4} and T-1 Diameter Packages
- General Purpose Leads
- Reliable and Rugged
- Available on Tape and Reel
- Binned for Color and Intensity

Applications

- Status Indicators
- Small Message Panel
- Running and Decorative Lights for Commercial Use

Description

These blue LEDs are designed in industry standard T-1 and T-1^{3/4} package with clear and non diffused optics. They are also available in tape and reel, and ammo-pack option for ease of handling and use.

These blue lamps are ideal for use as indicators and for general purpose lighting. Blue lamps offer color differentiation as blue is attractive and not widely available.

HLMP-DB25-B00xx
HLMP-KB45-A00xx



Package Dimensions

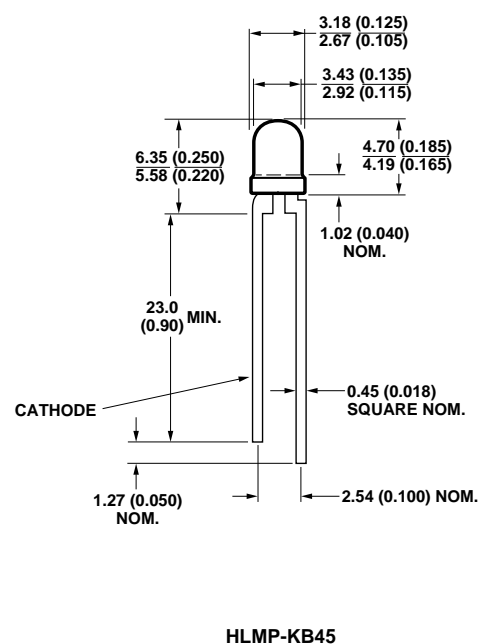
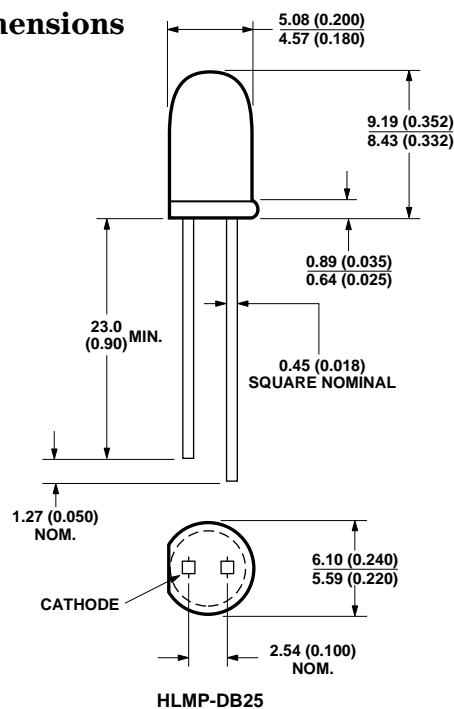

- NOTES:
1. ALL DIMENSIONS ARE IN MILLIMETERS (INCHES).
 2. EPOXY MENISCUS MAY EXTEND ABOUT 1 mm (0.040") DOWN THE LEADS.

CAUTION: Devices are Class II ESD sensitive. Please observe appropriate precautions during handling and processing. Refer to Application Note AN-1142 for additional details.

Selection Guide

Part Number	Package	Viewing Angle	Luminous Intensity Iv (mcd)	
			Min.	Max.
HLMP-KB45-A00xx	T-1	40	30	–
HLMP-DB25-B00xx	T-1 3/4	25	40	–

Part Numbering System

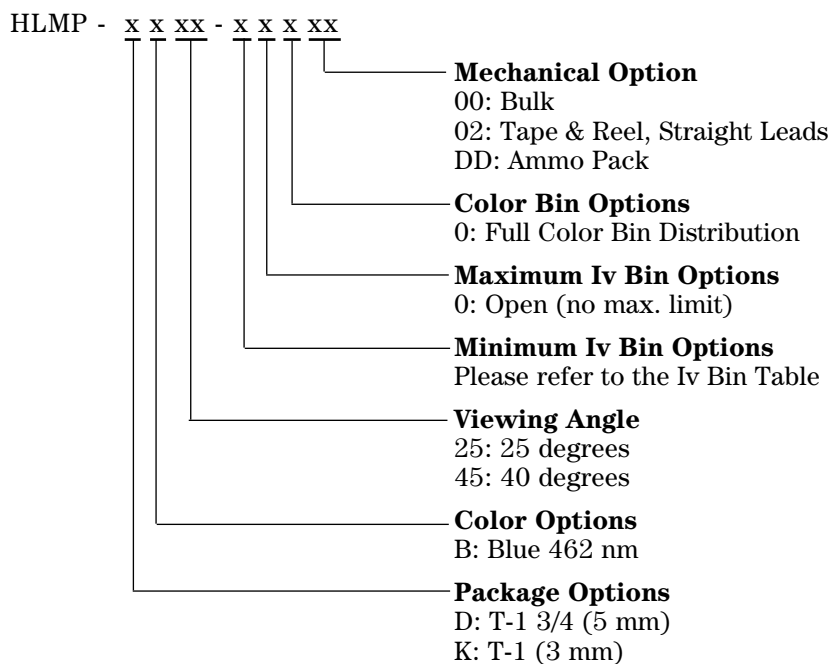

Absolute Maximum Ratings at $T_A = 25^\circ\text{C}$

Parameter	Blue	Units
Peak Forward Current	70	mA
DC Current ^[1]	30	mA
Reverse Voltage ($I_R = 100\ \mu\text{A}$)	5	V
Transient Forward Current ^[2] (10 μsec Pulse)	350	mA
LED Junction Temperature	115	$^\circ\text{C}$
Operating Temperature	-20 to +80	$^\circ\text{C}$
Storage Temperature	-30 to +100	$^\circ\text{C}$
Lead Soldering Temperature [1.6 mm (0.063 in.) from body]	260 $^\circ\text{C}$ for 5 seconds	

Notes:

- Derate linearly from 50 $^\circ\text{C}$ as shown in Figure 6.
- The transient peak current is the maximum non-recurring peak current that can be applied to the device without damaging the LED die and wirebond. It is not recommended that this device be operated at peak currents above the Absolute Maximum Peak Forward Current.

Optical Characteristics at $T_A = 25^\circ\text{C}$

Part Number	Luminous Intensity I_V (mcd) @ $I_F = 20\text{ mA}$		Color, Dominant Wavelength $\lambda_d^{[1]}$ (nm) Typ.	Peak Wavelength λ_{PEAK} (nm) Typ.	Viewing Angle $2\theta_{1/2}^{[2]}$ Degrees Typ.
	Min.	Typ.			
HLMP-DB25-B00xx	40	100	462	426	25
HLMP-KB45-A00xx	30	45	462	426	40

Notes:

1. The dominant wavelength, λ_d , is derived from the CIE chromaticity diagram and represents the single wavelength which defines the color of the device.
2. $\theta_{1/2}$ is the off-axis angle at which the luminous intensity is half of the axial luminous intensity.

Electrical Characteristics at $T_A = 25^\circ\text{C}$

Part Number	Forward Voltage V_F (Volts) @ $I_F = 20\text{ mA}$		Reverse Breakdown V_R (Volts) @ $I_R = 100\ \mu\text{A}$		Speed Response τ_s (ns) Typ.	Capacitance C (pF), $V_F = 0$, $f = 1\text{ MHz}$ Typ.	Thermal Resistance $R\theta_{J-PIN}$ ($^\circ\text{C}/\text{W}$) Junction to Cathode Lead Typ.
	Typ.	Max.	Min.	Typ.			
HLMP-DB25-B00xx	4.0	5.0	5.0	30	500	97	260
HLMP-KB45-A00xx	4.0	5.0	5.0	30	500	97	290

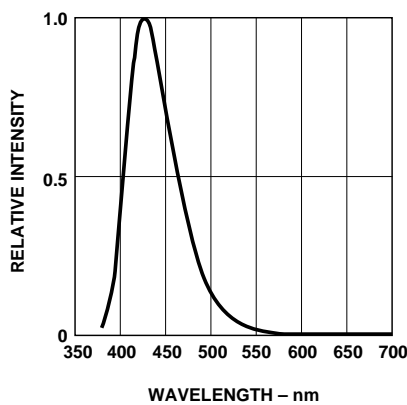

Figure 1. Relative Intensity vs. Wavelength.

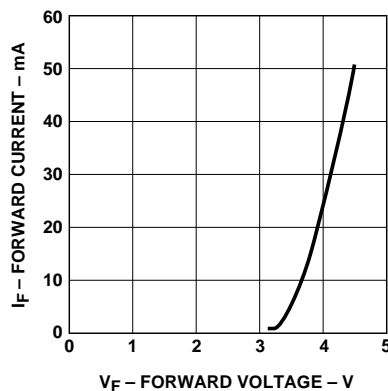

Figure 2. Forward Current vs. Forward Voltage.

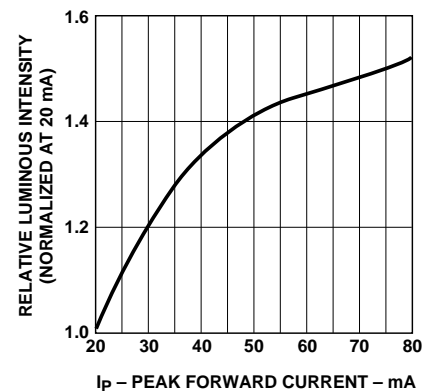

Figure 3. Relative Intensity vs. Peak Forward Current (300 μs pulse width, 10 ms period).

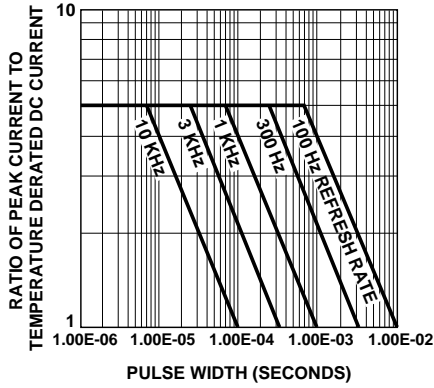

Figure 4. Forward Current vs. Forward Voltage.

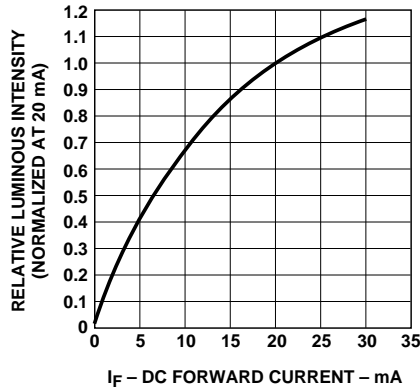

Figure 5. Relative Luminous Intensity vs. Forward Current.

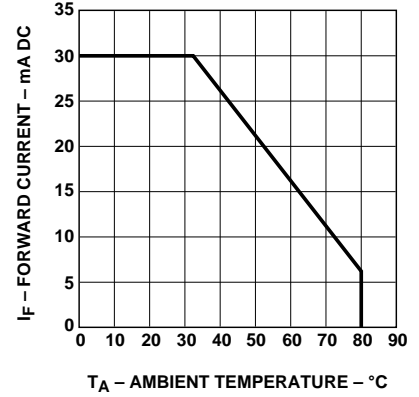

Figure 6. Maximum DC Forward Current vs. Ambient Temperature. Derating Based on T_j Max. = 115 °C.

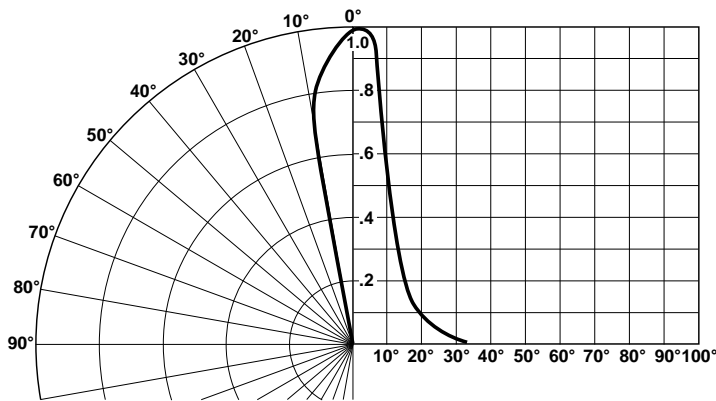

Figure 7. Relative Luminous Intensity vs. Angular Displacement for HLMP-DB25.

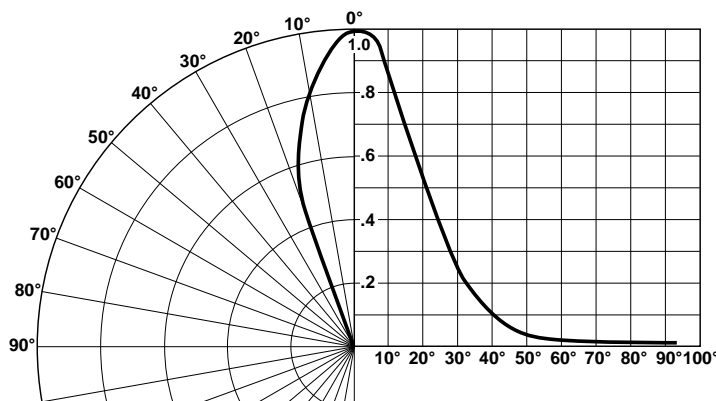

Figure 8. Relative Luminous Intensity vs. Angular Displacement for HLMP-KB45.

Soldering/Cleaning

Cleaning agents from the ketone family (acetone, methyl ethyl ketone, etc.) and from the chlorinated hydrocarbon family (methylene chloride, trichloroethylene, carbon tetrachloride, etc.) are not recommended for cleaning LED parts. All of these various solvents attack or dissolve the encapsulating epoxies used to form the package of plastic LED parts.

For information on soldering LEDs, please refer to Application Note 1027.

Intensity Bin Limits

Bin	Intensity Range (mcd)	
	Min.	Max.
A	30.0	40.0
B	40.0	50.0
C	50.0	65.0
D	65.0	85.0
E	85.0	110.0
F	110.0	140.0
G	140.0	180.0
H	180.0	240.0
J	240.0	310.0
K	310.0	400.0
L	400.0	520.0
M	520.0	680.0
N	680.0	880.0

Color Bin Limits (nm at 20 mA)

Blue	nm @ 20 mA	
Bin ID	Min.	Max.
1	460.0	464.0
2	464.0	468.0
3	468.0	472.0
4	472.0	476.0
5	476.0	480.0

Tolerance for each bin limit will be $\pm 0.5\text{nm}$.

Mechanical Option Matrix

Mechanical Option Code	Definition
00	Bulk Packaging, minimum increment 500 pcs/bag
02	Tape & Reel, straight leads, minimum increment 1300 pcs/bag
DD	Ammo Pack, straight leads with minimum increment

Note:

All categories are established for classification of products. Products may not be available in all categories. Please contact your local Agilent representative for further clarification/information.



Agilent Technologies

www.agilent.com/semiconductors

For product information and a complete list of distributors, please go to our web site.

For technical assistance call:

Americas/Canada: +1 (800) 235-0312 or
(408) 654-8675

Europe: +49 (0) 6441 92460

China: 10800 650 0017

Hong Kong: (+65) 6756 2394

India, Australia, New Zealand: (+65) 6755 1939

Japan: (+81 3) 3335-8152 (Domestic/International), or 0120-61-1280 (Domestic Only)

Korea: (+65) 6755 1989

Singapore, Malaysia, Vietnam, Thailand,
Philippines, Indonesia: (+65) 6755 2044

Taiwan: (+65) 6755 1843

Data subject to change.

Copyright © 2003 Agilent Technologies, Inc.

Obsoletes 5988-2226EN

May 12, 2003

5988-9507EN