



UT6402

Power MOSFET

N-CHANNEL ENHANCEMENT MODE

■ DESCRIPTION

The **UT6402** is N-Channel enhancement mode Power MOSFET, designed with high density cell, with fast switching speed, low on-resistance, excellent thermal and electrical capabilities, operation with low gate voltages.

This device is suitable for use as a load switch or in PWM applications.

■ SYMBOL

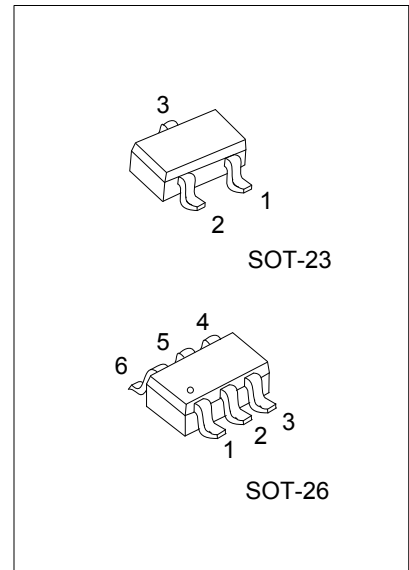
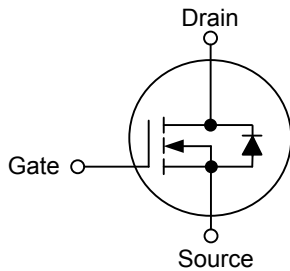

■ ORDERING INFORMATION

Ordering Number		Package	Pin Assignment						Packing
Lead Free Plating	Halogen-Free		1	2	3	4	5	6	
UT6402L-AE3-R	UT6402G-AE3-R	SOT-23	S	G	D	-	-	-	Tape Reel
UT6402L-AG6-R	UT6402G-AG6-R	SOT-26	D	D	G	S	D	D	Tape Reel

<p>UT6402L-AE3-R</p> <p>(1)Packing Type</p> <p>(2)Package Type</p> <p>(3)Lead Plating</p>	<p>(1) R: Tape Reel</p> <p>(2) AE3: SOT-23, AG6: SOT-26</p> <p>(3) L: Lead Free Plating, G: Halogen Free</p>
---	--

■ MARKING

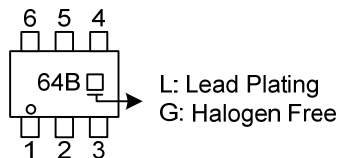
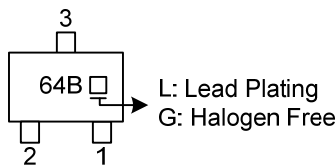

■ ABSOLUTE MAXIMUM RATINGS ($T_A = 25^\circ\text{C}$, unless otherwise specified)

PARAMETER	SYMBOL	RATINGS	UNIT
Drain-Source Voltage	V_{DSS}	30	V
Gate-Source Voltage	V_{GSS}	± 20	V
Continuous Drain Current (Note 3)	I_D	6.9	A
Pulsed Drain Current (Note 2)	I_{DM}	20	A
Power Dissipation	P_D	2	W
Junction Temperature	T_J	+150	$^\circ\text{C}$
Storage Temperature	T_{STG}	-55 ~ +150	$^\circ\text{C}$

Note: Absolute maximum ratings are those values beyond which the device could be permanently damaged.
Absolute maximum ratings are stress ratings only and functional device operation is not implied.

■ THERMAL DATA

PARAMETER	SYMBOL	MIN	TYP	MAX	UNIT
Junction to Ambient (Note 3)	θ_{JA}		74	110	$^\circ\text{C}/\text{W}$

■ ELECTRICAL CHARACTERISTICS ($T_J = 25^\circ\text{C}$, unless otherwise specified)

PARAMETER	SYMBOL	TEST CONDITIONS	MIN	TYP	MAX	UNIT
OFF CHARACTERISTICS						
Drain-Source Breakdown Voltage	BV_{DSS}	$V_{GS} = 0\text{ V}, I_D = 250\mu\text{A}$	30			V
Drain-Source Leakage Current	I_{DSS}	$V_{DS} = 30\text{V}, V_{GS} = 0\text{ V}$			1	μA
Gate-Source Leakage Current	I_{GSS}	$V_{DS} = 0\text{ V}, V_{GS} = \pm 20\text{V}$			± 100	nA
ON CHARACTERISTICS						
Gate Threshold Voltage	$V_{GS(TH)}$	$V_{DS} = V_{GS}, I_D = 250\mu\text{A}$	1	1.9	3	V
On State Drain Current	$I_{D(ON)}$	$V_{DS} = 5\text{V}, V_{GS} = 4.5\text{V}$	20			A
Static Drain-Source On-Resistance (Note 2)	$R_{DS(ON)}$	$V_{GS} = 10\text{V}, I_D = 6.9\text{A}$		22.5	28	m Ω
		$V_{GS} = 4.5\text{V}, I_D = 5.0\text{A}$		34.5	42	m Ω
DYNAMIC CHARACTERISTICS						
Input Capacitance	C_{ISS}	$V_{DS} = 15\text{ V}, V_{GS} = 0\text{V}, f = 1\text{MHz}$		680	820	pF
Output Capacitance	C_{OSS}			102		
Reverse Transfer Capacitance	C_{RSS}			77	108	
SWITCHING CHARACTERISTICS						
Turn-ON Delay Time (Note 2)	$t_{D(ON)}$	$V_{GS} = 10\text{V}, V_{DS} = 15\text{V}, R_L = 2.2\Omega, R_G = 3\Omega$		4.6		ns
Turn-ON Rise Time	t_R			4.1		
Turn-OFF Delay Time	$t_{D(OFF)}$			20.6		
Turn-OFF Fall-Time	t_F			5.2		
Total Gate Charge (Note 2)	Q_G	$V_{DS} = 15\text{V}, V_{GS} = 10\text{V}, I_D = 6.9\text{A}$	11.5	13.88	16.7	nC
Gate Source Charge	Q_{GS}			1.82		
Gate Drain Charge	Q_{GD}			3.2		
SOURCE- DRAIN DIODE RATINGS AND CHARACTERISTICS						
Drain-Source Diode Forward Voltage	V_{SD}	$I_S = 1\text{A}$		0.76	1	V
Maximum Body-Diode Continuous Current	I_S				3	A
Reverse Recovery Time	t_{RR}	$I_F = 6.9\text{ A}, dI/dt = 100\text{A}/\mu\text{s}$		16.5	20	ns
Reverse Recovery Charge	Q_{RR}	$I_F = 6.9\text{ A}, dI/dt = 100\text{A}/\mu\text{s}$		7.8		nC

- Notes: 1. Pulse width limited by $T_{J(MAX)}$
 2. Pulse width $\leq 300\mu\text{s}$, duty cycle $\leq 0.5\%$.
 3. Surface mounted on 1 in² copper pad of FR4 board.

TYPICAL CHARACTERISTICS

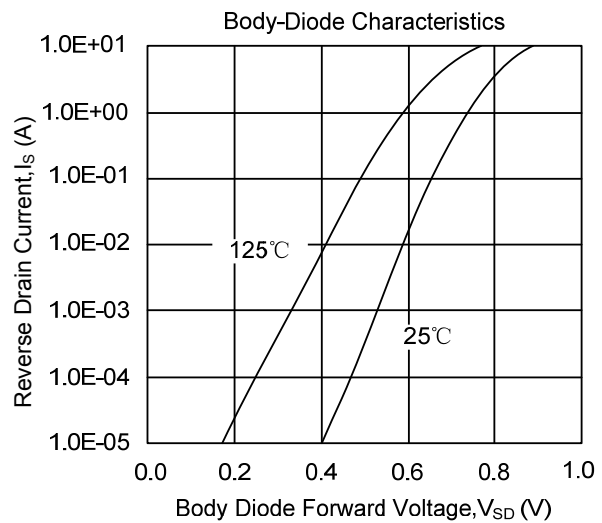
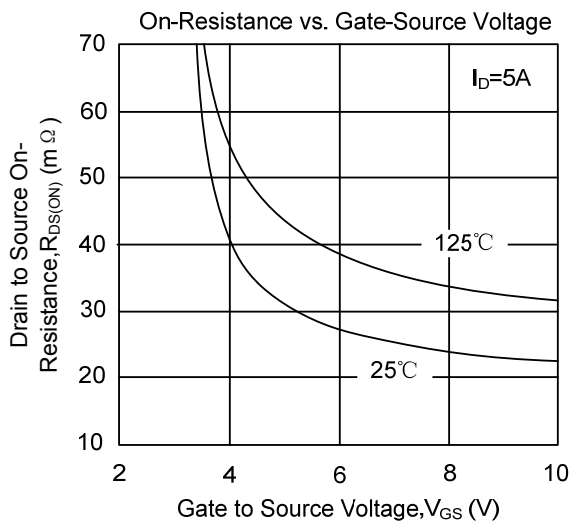
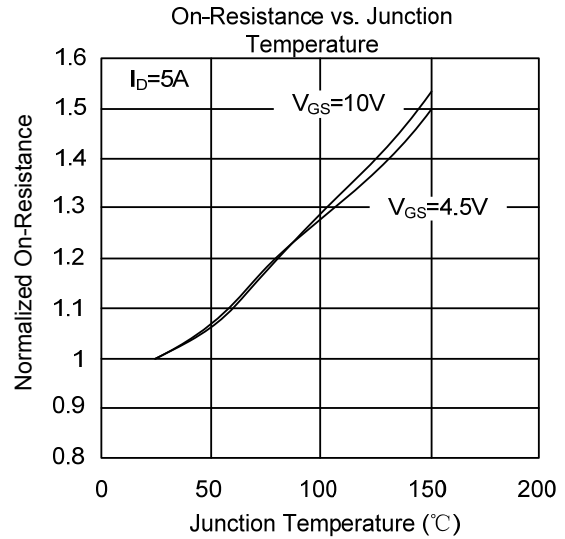
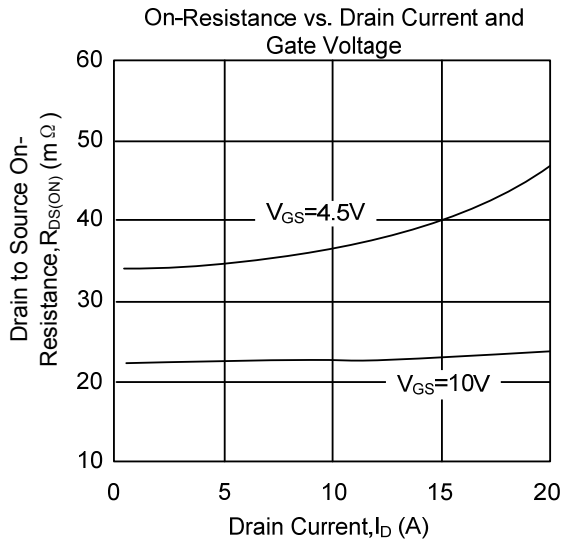
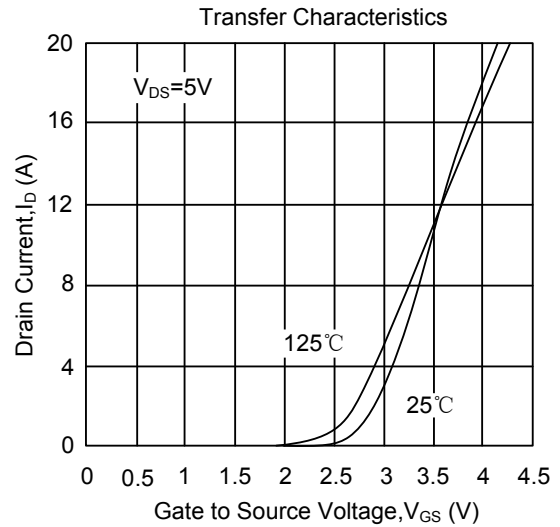
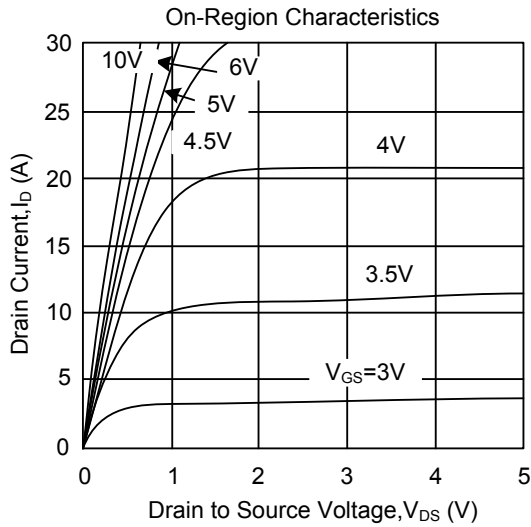

TYPICAL CHARACTERISTICS(Cont.)

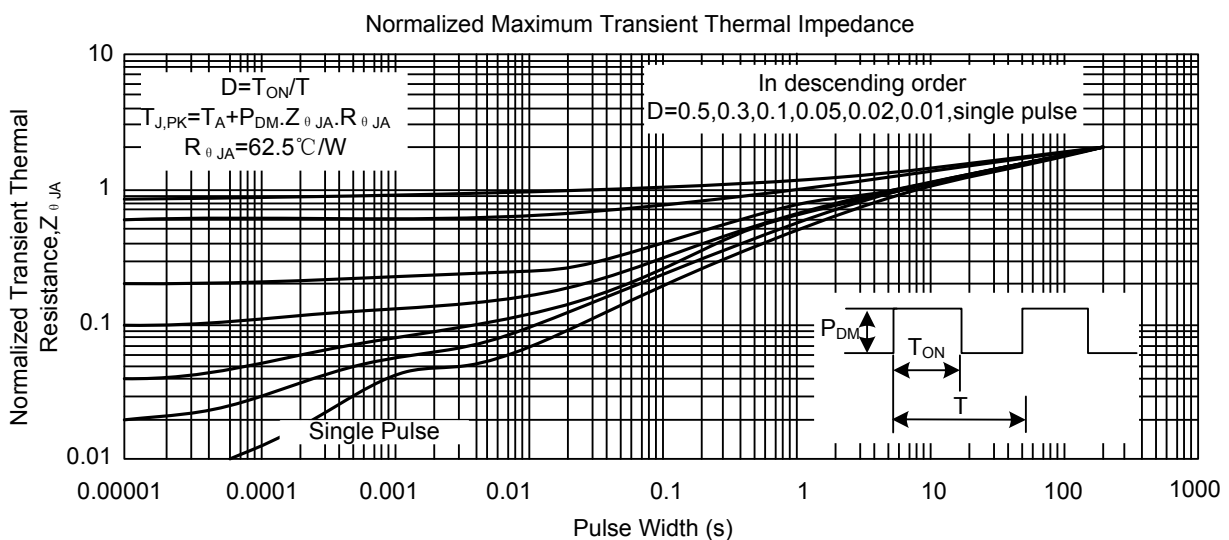
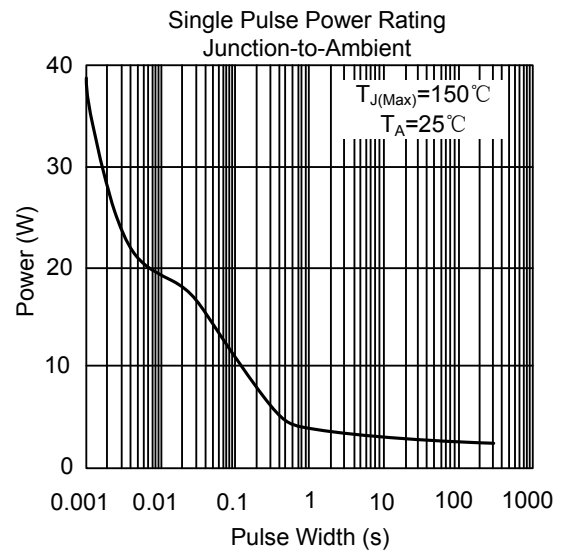
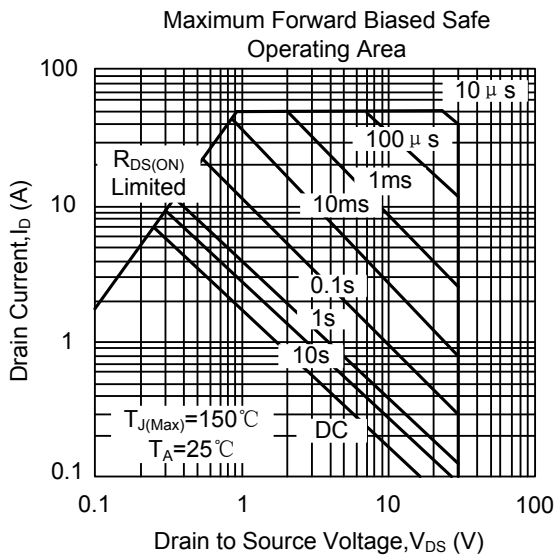
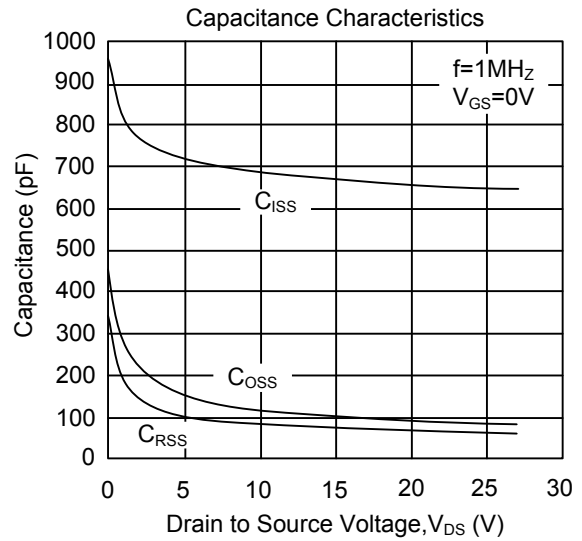
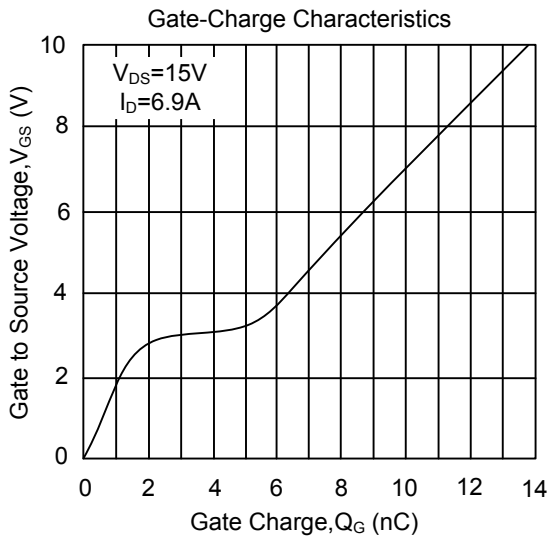

UTC assumes no responsibility for equipment failures that result from using products at values that exceed, even momentarily, rated values (such as maximum ratings, operating condition ranges, or other parameters) listed in products specifications of any and all UTC products described or contained herein. UTC products are not designed for use in life support appliances, devices or systems where malfunction of these products can be reasonably expected to result in personal injury. Reproduction in whole or in part is prohibited without the prior written consent of the copyright owner. The information presented in this document does not form part of any quotation or contract, is believed to be accurate and reliable and may be changed without notice.