



























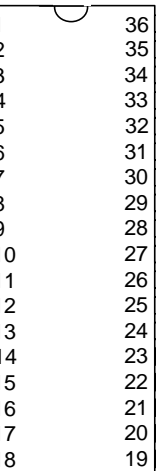









FEATURES

- Fully compliant with Ultra2, Ultra3, and Ultra 160/m SCSI
- Provides Multimode Low Voltage Differential/Single-Ended (LVD/SE) termination for 9 signal line pairs
- Auto-selection of LVD or SE termination
- 5% tolerance on SE and LVD termination resistance
- Low power down capacitance of 3 pF
- Onboard thermal shutdown circuitry
- SCSI bus hot plug compatible
- Fully supports actively negated SE SCSI signals

PIN ASSIGNMENT

VREF  1 NC  2 NC  3 R1P  4 R1N  5 R2P  6 R2N  7 HS GND  8 HS GND  9 HS GND  10 R3P  11 R3N  12 R4P  13 R4N  14 R5P  15 R5N  16 ISO  17 GND  18		36  TPWR 35  HVD 34  LVD 33  SE 32  R9N 31  R9P 30  R8N 29  R8P 28  HS GND 27  HS GND 26  HS GND 25  R7N 24  R7P 23  R6N 22  R6P 21  DIFF_CAP 20  DIFFSENSE 19  MSTR/SLV
---	--	---

DS2117MB 36-Pin SSOP

DESCRIPTION

The DS2117M Ultra3 LVD/SE SCSI Terminator is both a Low Voltage Differential (LVD) and Single-Ended (SE) terminator. The multimode operation enables the designer to implement LVD in current products while allowing the end-user SE backward compatibility with legacy devices. If the device is connected in an LVD-only bus, the DS2117M will use LVD termination. If any SE devices are connected to the bus, the DS2117M will use SE termination. This is accomplished automatically inside the part by sensing the voltage on the SCSI bus DIFFSENS line.

For the LVD termination, the DS2117M integrates two current sources with nine precision resistor strings. For the SE termination, one regulator and nine precision 110-ohm resistors are used. Three DS2117M terminators are needed for a wide SCSI bus.

REFERENCE DOCUMENTS

Small Computer Systems Interface (SCSI-3)	SCSI Parallel Interface (SPI)	Project: 0855-M, 1995
Small Computer Systems Interface (SCSI-3)	SCSI Parallel Interface 2 (SPI-2)	Project: 1142-M, 1998
Small Computer Systems Interface (SCSI-3)	SCSI Parallel Interface 3 (SPI-3)	Project: 1302-D, 1999
Small Computer Systems Interface (SCSI-3)	SCSI Parallel Interface 4 (SPI-4)	Project: 1365-D, xxxx

Available from:

American National Standards Institute (ANSI) Phone: (212) 642-4900
 Global Engineering Documents 15 Inverness Way East; Englewood, CO 80112 Phone: (800) 854-7179

FUNCTIONAL DESCRIPTION

The DS2117 combines LVD and SE termination with DIFFSENSE sourcing and detection.

A bandgap reference is fed into two amplifiers, which creates a 1.25V reference voltage and a 2.85V reference voltage. The control logic determines which of these references will be applied to the termination resistors. If the SCSI bus is in LVD mode, then the 1.25V reference will be used. If the SCSI bus is in SE mode, then the 2.85V reference will be used. That same control logic will switch in/out parallel resistors to change the total termination resistance accordingly. Finally, in SE mode the Rp pins will be switched to ground.

The DIFFSENSE circuitry decodes trinary logic. There will be one of three voltages on the SCSI control line called DIFFSENS. Two comparators and a NAND gate determine if the voltage is below 0.6V, above 2.15V, or in between. That indicates the mode of the bus to be HVD, SE, or LVD, respectively.

The DS2117M's DIFF_CAP pin monitors the DIFFSENS line to determine the proper operating mode of the device; this mode is indicated by the SE/LVD/HVD outputs. The DIFFSENSE pin can also drive the SCSI DIFFSENS line (when MSTR/SLV = 1) to determine the SCSI bus operating mode. The DS2117M switches to the termination mode that is appropriate for the bus based on the value of the DIFFSENS voltage. These modes are:

LVD mode LVD termination is provided by a precision laser trimmed resistor string with two current sources. This configuration yields a 105Ω differential and 150Ω common mode impedance. A fail-safe bias of 112 mV is maintained when no drivers are connected to the SCSI bus.

SE mode When the external driver for a given signal line turns off, the active terminator will pull that signal line to 2.85 volts (quiescent state). When used with an active negation driver, the power amp can sink 22 mA per line while keeping the voltage reference in regulation. The terminating resistors maintain their 110Ω value.

HVD Isolation Mode The DS2117M identifies that there is an HVD (high voltage differential) device on the SCSI bus and isolates the termination pins from the bus.

When ISO is pulled high, the termination pins are isolated from the SCSI bus, Vref is grounded, and the bus mode indicators (SE/LVD/HVD) remain active. During thermal shutdown, the termination pins are isolated from the SCSI bus, Vref is grounded, and the bus mode indicators (SE/LVD/HVD) remain active. The DIFFSENSE driver is shut down during either of these two events.

To ensure proper operation, the TPWR pin should be connected to the SCSI bus TERMPWR line. As with all analog circuitry, the TERMPWR and VDD lines should be bypassed locally. A 2.2 μF capacitor and a 0.01 μF high frequency capacitor is recommended between TPWR and ground and placed as close as possible to the DS2117M. The DS2117M should be placed as close as possible to the SCSI connector to minimize signal and power trace length, thereby resulting in less input capacitance and reflections which can degrade the bus signals.

To maintain the specified regulation, a 4.7 μF capacitor is required between the Vref pin (VREF) and ground of each DS2117M. A high frequency cap (0.1 μF ceramic recommended) can also be placed on the Vref pin in applications that use fast rise/fall time drivers. A typical SCSI bus configuration is shown in Figure 2.

DIFFSENS noise filtering The DS2117M incorporates a digital filter to remove high frequency transients on the DIFFSENS control line, thereby eliminating erroneous switching between modes. This filter eliminates the need for the external capacitor and resistor, which heretofore performed this function. The external filter may be used in addition to the digital filter if the DS2117M and DS2118M are to be used interchangeably.

NOTE:

DIFFSENS – Refers to the SCSI bus signal.

DIFFSENSE – Refers to the DS2117M pin name and internal circuitry capable of driving the DIFFSENS line.

DIFF_CAP - Refers to the DS2117M pin name and internal circuitry relating to monitoring the DIFFSENS line.

DS2117M BLOCK DIAGRAM Figure 1

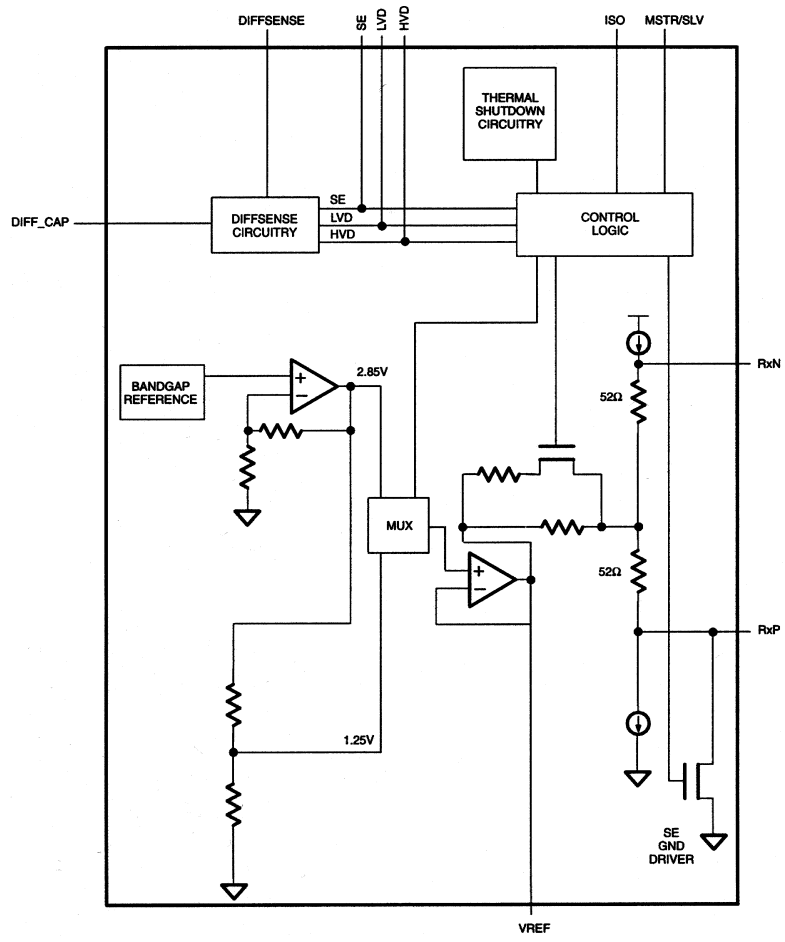

SCSI BUS CONFIGURATION Figure 2

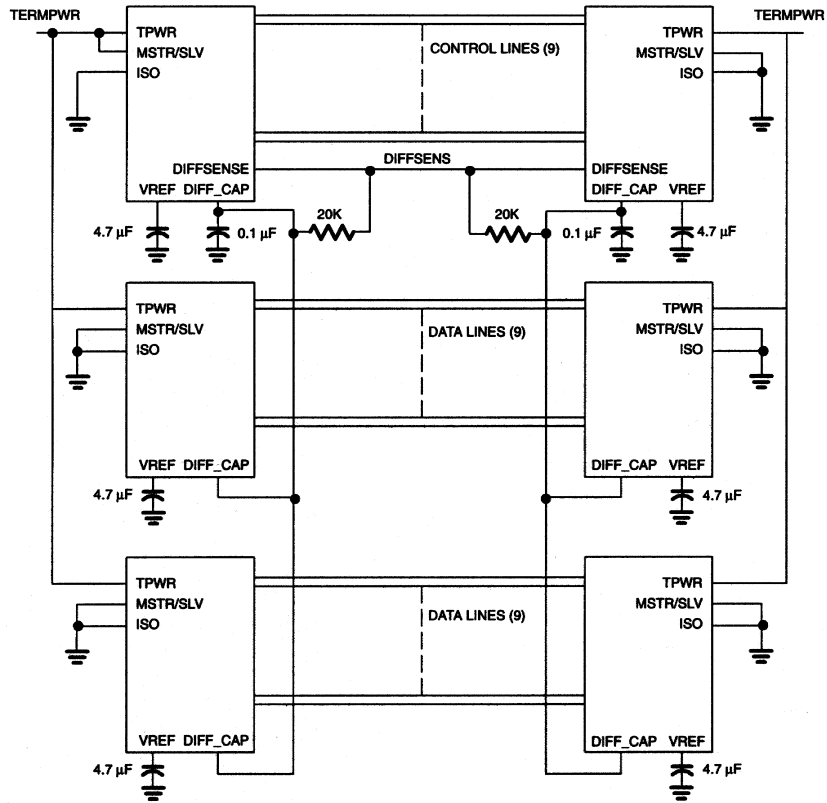

PIN DESCRIPTION Table 1

PIN	SYMBOL	DESCRIPTION
1	VREF	Reference Voltage. 2.85 volt reference in SE mode and 1.25 volt reference in LVD mode; must be decoupled with a 4.7 μ F cap.
2, 3	NC	No Connect. Do not connect these pins.
4-7, 11-16, 22-25, 29-32	RxP RxN	Signal Termination. Connect to SCSI bus signal lines.
8, 10, 26, 9, 28, 27	HS GND	Heat Sink Ground. Internally connected to the mounting pad. Should be grounded.
17	ISO	Isolation. When pulled high, the DS2117M isolates its bus pins (RxP, RxN) from the SCSI bus.
18	GND	Ground. Signal ground; 0.0 volts.
19	MSTR/SLV	Master/slave. Mode select for the non-controlling terminator. When pulled high (MSTR), the DIFFSENSE driver is enabled.
20	DIFFSENSE	DIFFSENSE. Output to drive the SCSI bus DIFFSENS line.
21	DIFF_CAP	DIFFSENSE CAPACITOR. Connect 0.1 μ F capacitor for DIFFSENSE filter. Input to detect the type of device (differential or single-ended) on the SCSI bus.
33	SE	Single-ended. SE output of DIFFSENSE receiver; output high indicates SE bus operation.
34	LVD	Low Voltage Differential. LVD output of DIFFSENSE receiver; output high indicates LVD bus operation.
35	HVD	High Voltage Differential. HVD output of DIFFSENSE receiver; output high indicates HVD bus operation or thermal shutdown.
36	TPWR	Termination Power. Connect to the SCSI TERMPWR line and decouple with 2.2 μ F capacitor.

RECOMMENDED OPERATING CONDITIONS

PARAMETER	SYMBOL	MIN	TYP	MAX	UNITS	NOTES
Termpower Voltage	SE mode	$V_{tpwr(SE)}$	4.0		5.5	V
	LVD mode	$V_{tpwr(LVD)}$	2.7		5.5	V
Logic 0	V_{il}	-0.3		+0.8	V	
Logic 1	V_{ih}	2.0		$V_{tpwr} + 0.3$	V	
Operating Temperature	V_{amb}	0		70	$^{\circ}$ C	

SINGLE ENDED CHARACTERISTICS

PARAMETER	SYMBOL	MIN	TYP	MAX	UNITS	NOTES
SE Termination Resistance	Rse	104.5	110	115.5	Ohms	1
SE Voltage Reference	Vref	2.7		3.0	Volts	
SE Output Current	Iose			25.4	mA	2
Output Capacitance	Cout			3	pF	3

LOW VOLTAGE DIFFERENTIAL CHARACTERISTICS

PARAMETER	SYMBOL	MIN	TYP	MAX	UNITS	NOTES
Differential Mode Termination Resistance	Rdm	100		110	Ohms	
Common Mode Termination Resistance	Rcm	110		190	Ohms	
Differential Mode Bias	Vdm	100		125	mV	4
Common Mode Bias	Vcm	1.125		1.375	V	

DC CHARACTERISTICS

PARAMETER	SYMBOL	MIN	TYP	MAX	UNITS	NOTES
Termpower Current	I _{tpmr}		12		mA	4
Input Leakage High	I _{ih}	-1.0			μA	
Input Leakage Low	I _{il}			1.0	μA	
Output Current High	I _{oh}	-1.0			mA	5, 7
Output Current Low	I _{ol}	4.0			mA	6, 7
DIFFSENS SE Operating Range	V _{seor}	-0.3		0.5	V	
DIFFSENS LVD Operating Range	V _{lvdor}	0.7		1.9	V	
DIFFSENS HVD Operating Range	V _{hvdor}	2.4		V _{tpwr} + 0.3	V	
DIFFSENSE Driver Output Voltage	V _{dso}	1.2		1.4	V	8, 9
DIFFSENSE Driver Source Current	I _{dsh}	5		15	mA	8, 10, 12
DIFFSENSE Driver Sink Current	I _{dsl}	20		200	μA	8, 11
Thermal Shutdown			150		°C	3

REGULATOR CHARACTERISTICS

PARAMETER	SYMBOL	MIN	TYP	MAX	UNITS	NOTES
Line Regulation	L_{REG}		1.0	2.5	%	
Load Regulation	L_{OREG}		1.3	3.5	%	
Current Limit	I_{LIM}		550		mA	
Sink Current	I_{SINK}	200			mA	

NOTES:

1. $V_{line} = 0-3.0$ volts.
2. $V_{line} = 0.2$ volts.
3. Guaranteed by design.
4. All lines open.
5. $V_{OUT} = 2.4$ volts.
6. $V_{OUT} = 0.4$ volts.
7. SE/LVD/HVD pins only.
8. $MSTR/SLV = 1$.
9. $I_{ds} = 0-5$ mA.
10. $V_{dso} = 0.0$ volts.
11. $V_{dso} = 2.75$ volts.
12. $TPWR = 5.5V$

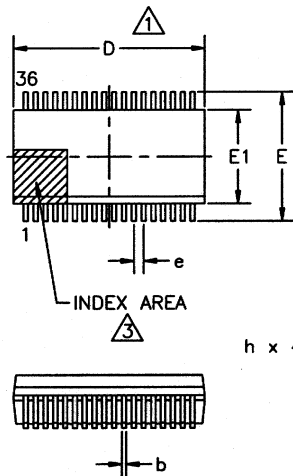
DS2117M 36-PIN SSOP PACKAGE

△1 DIMENSIONS D AND E1 INCLUDE MOLD MISMATCH, BUT DO NOT INCLUDE MOLD FLASH, PROTRUSIONS OR GATE BURRS. MOLD FLASH, PROTRUSIONS OR GATE BURRS SHALL NOT EXCEED 0.254 MM PER SIDE.

△2 SECTION A-A DIMENSIONS APPLY TO THE FLAT SECTION OF THE LEAD BETWEEN 0.13 TO 0.25 MM FROM THE LEAD TIP.

△3 THE CHAMFER ON THE BODY IS OPTIONAL. IF IT IS NOT PRESENT, A VISUAL INDEX FEATURE MUST BE LOCATED WITHIN THE CROSS-HATCHED AREA.

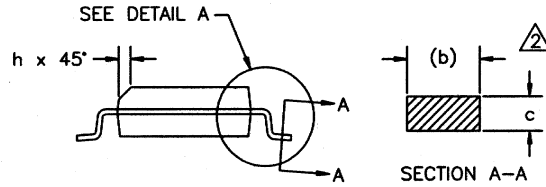

DIM	MIN	MAX
A	2.44	2.64
A1	0.12	-
b	0.29	0.43
c	0.23	0.32
D	15.20	15.54
E	10.11	10.52
E1	7.40	7.60
e	0.80 BSC	
h	0.25	0.71
L	0.51	1.02

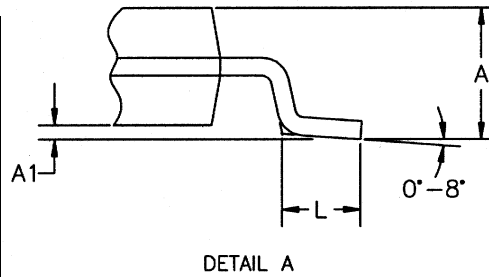

DIMENSIONS ARE IN MILLIMETERS

CSP option - mechanical drawing

Please check the following web location for latest information on our Chip Scale Package (a.k.a "solder bump") "<http://www.dalsemi.com/DocControl/Chips/index.html>"