



2SA928A

PNP SILICON TRANSISTOR

AUDIO POWER AMPLIFIER

■ FEATURES

- * Collector Dissipation $P_C=1$ W
- * 3 W Output Application
- * Complement of 2SC2328A

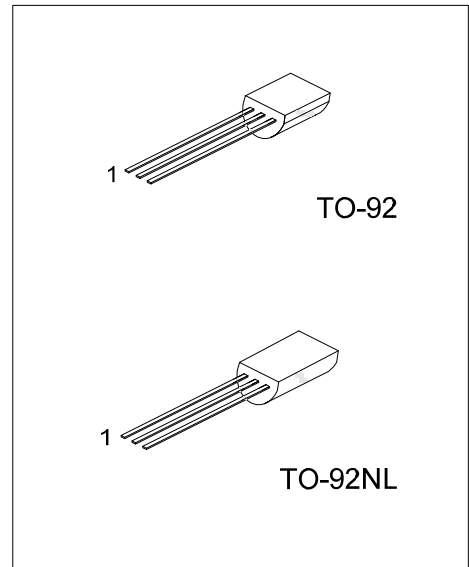

■ ORDERING INFORMATION

Ordering Number			Package	Pin Assignment			Packing
Normal	Lead Free	Halogen Free		1	2	3	
2SA928A-x-T92-B	2SA928AL-x-T92-B	2SA928AG-x-T92-B	TO-92	E	C	B	Tape Box
2SA928A-x-T92-K	2SA928AL-x-T92-K	2SA928AG-x-T92-K	TO-92	E	C	B	Bulk
2SA928A-x-T9N-B	2SA928AL-x-T9N-B	2SA928AG-x-T9N-B	TO-92NL	E	C	B	Tape Box
2SA928A-x-T9N-K	2SA928AL-x-T9N-K	2SA928AG-x-T9N-K	TO-92NL	E	C	B	Bulk

<p>2SA928AL-x-T92-B</p>	<p>(1) B: Tape Box, K: Bulk</p> <p>(2) T92: TO-92, T9N: TO-92NL</p> <p>(3) x: refer to Classification of h_{FE}</p> <p>(4) G: Halogen Free, L: Lead Free, Blank: Pb/Sn</p>
-------------------------	---

■ ABSOLUTE MAXIMUM RATINGS (Ta=25°C, unless otherwise specified)

PARAMETER	SYMBOL	RATINGS	UNIT
Collector- Base Voltage	V_{CBO}	-30	V
Collector-Emitter Voltage	V_{CEO}	-30	V
Emitter-Base Voltage	V_{EBO}	-5	V
Collector Current	I_C	-2	A
Collector Dissipation	P_C	1	W
Junction Temperature	T_J	+150	°C
Storage Temperature	T_{STG}	-55 ~ +150	°C

Note: Absolute maximum ratings are those values beyond which the device could be permanently damaged. Absolute maximum ratings are stress ratings only and functional device operation is not implied.

■ ELECTRICAL CHARACTERISTICS (Ta=25°C, unless otherwise specified)

PARAMETER	SYMBOL	TEST CONDITIONS	MIN	TYP	MAX	UNIT
Collector-Base Breakdown Voltage	BV_{CBO}	$I_C = -100\mu A, I_E = 0$	-30			V
Collector-Emitter Breakdown Voltage	BV_{CEO}	$I_C = -1mA, I_B = 0$	-30			V
Emitter-Base Breakdown Voltage	BV_{EBO}	$I_E = -1mA, I_C = 0$	-5			V
Collect Cut-off Current	I_{CBO}	$V_{CB} = -30V, I_E = 0$			-100	nA
Emitter Cut-off Current	I_{EBO}	$V_{BE} = -5V, I_C = 0$			-100	nA
DC Current Ratio	h_{FE}	$V_{CE} = -2V, I_C = -500mA$	100		320	
Base-Emitter on Voltage	$V_{BE(ON)}$	$V_{CE} = -2V, I_C = -500mA$			-1	V
Collector-Emitter Saturation Voltage	$V_{CE(SAT)}$	$I_C = -1.5A, I_B = -30mA$			-2	V
Output Capacitance	C_{OB}	$V_{CB} = -10V, I_E = 0, f = 1MHz$		48		pF
Current Gain Bandwidth Product	f_T	$V_{CE} = -2V, I_C = -500mA$		120		MHz

■ CLASSIFICATION OF h_{FE}

RANK	Q	Y
RANGE	100 ~ 200	160 ~ 320

TYPICAL CHARACTERISTICS

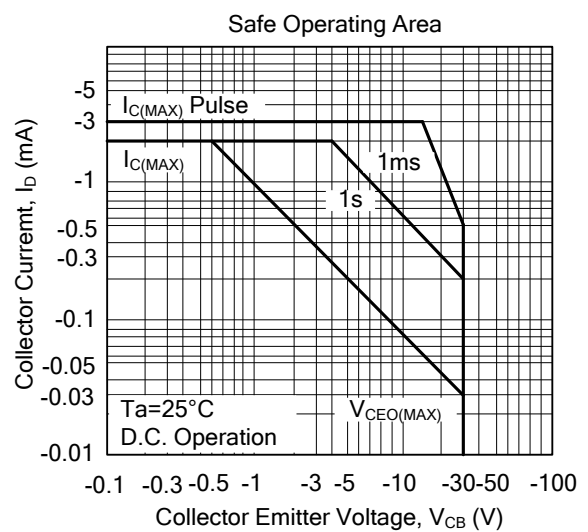
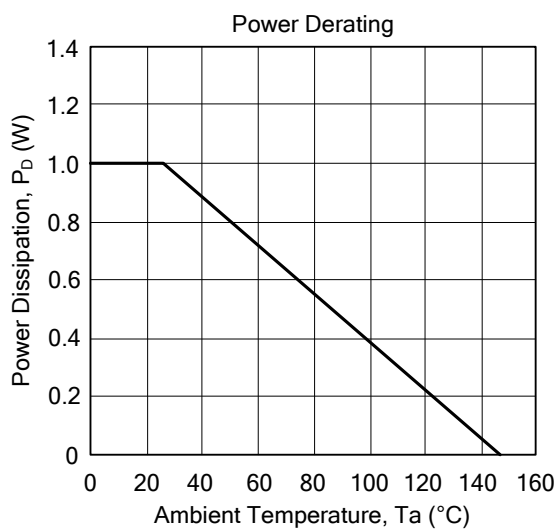
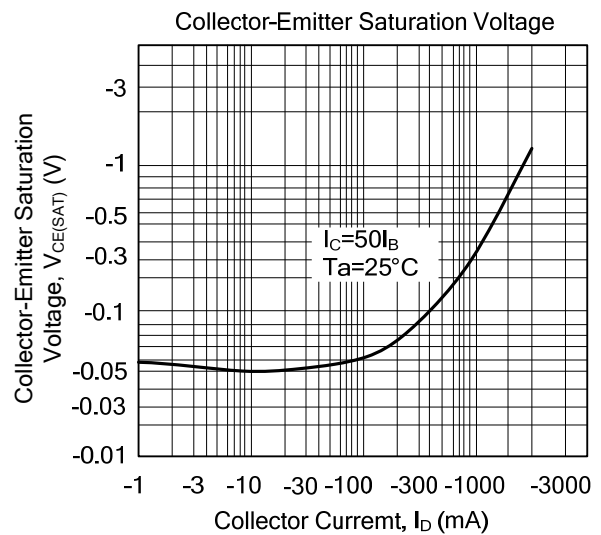
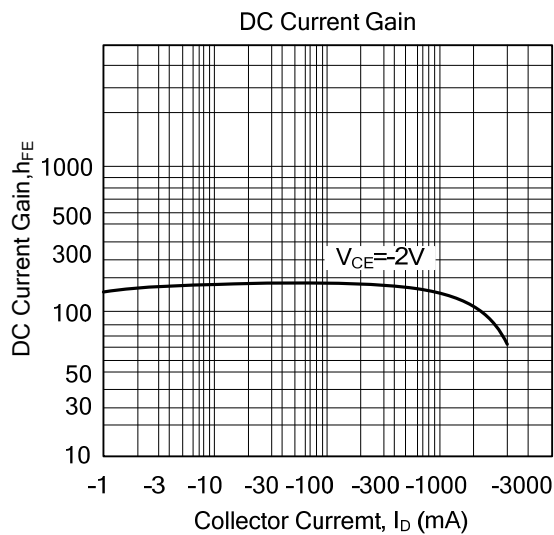
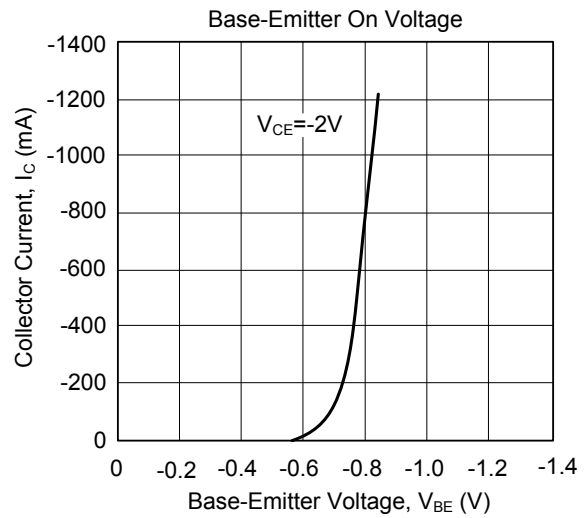
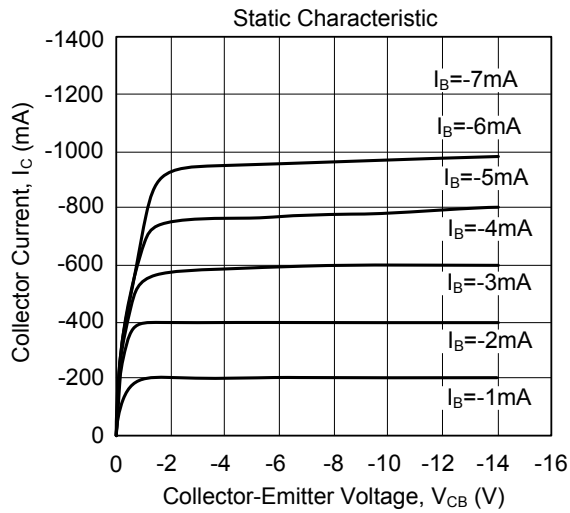

UTC assumes no responsibility for equipment failures that result from using products at values that exceed, even momentarily, rated values (such as maximum ratings, operating condition ranges, or other parameters) listed in products specifications of any and all UTC products described or contained herein. UTC products are not designed for use in life support appliances, devices or systems where malfunction of these products can be reasonably expected to result in personal injury. Reproduction in whole or in part is prohibited without the prior written consent of the copyright owner. The information presented in this document does not form part of any quotation or contract, is believed to be accurate and reliable and may be changed without notice.