



# PRODUCT SPECIFICATION

**Model No : CSM-58211M9/58221M9**

## Descriptions:

- 2.3 Inch 5X8 Dot-Matrix Display
- Dot Pitch 7.62mm
- CSM-58221: Column Anode, Row Cathode
- CSM-58221: Column Cathode, Row Anode
- Emitting Color: Super Bright Green



CUSTOMER APPROVED SIGNATURES	APPROVED BY	CHECKED BY	PREPARED BY

**CHINA SEMICONDUCTOR CORPORATION**  
Address:2FL. NO.909,Chung-Cheng Road,  
Chung-Ho City Taipei Hsien,Taiwan.

Tel:886-2-2223-9696  
Fax:886-2-2223-9377

**OPTO PLUS TECHNOLOGIES CO.,LTD**  
Address:696 Shun jiang Rd.,Ji Shan St.Shaoxing,  
ZheJiang,China

Tel:86-0575-8623888  
Fax:86-0575-8623112



**Model No : CSM-58211/58221M9**

**■ Features -**

1. 2.3 inch (58.34mm) Matrix height.
2. Case mold type.
3. RoHs compliant.
4. Low power consumption.
5. Easy mounting on P.C. board or socket.

**■ Device Selection Guide -**

Part No.	Chip		Column	Row
	Material	Emitted Color		
CSM-58211M9	AlGaInP	Super Bright Green	Anode	Cathode
CSM-58221M9	AlGaInP	Super Bright Green	Cathode	Anode

**■ Package Dimensions -**

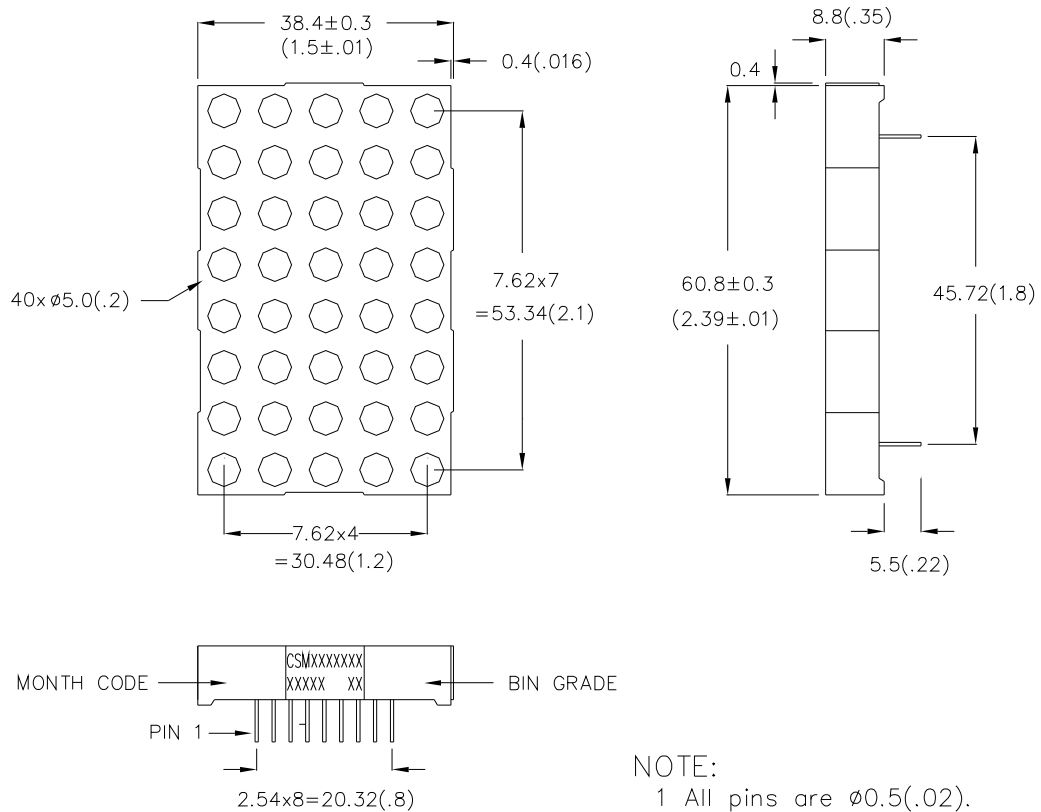

**NOTE:**

- 1 All pins are  $\phi 0.5$  (.02).
- 2 Dimension in millimeters (inch), tolerance is  $\pm 0.25$  (.01) unless otherwise noted.



Model No : CSM-58211/58221M9

Internal Circuit Diagrams -

CSM-58221

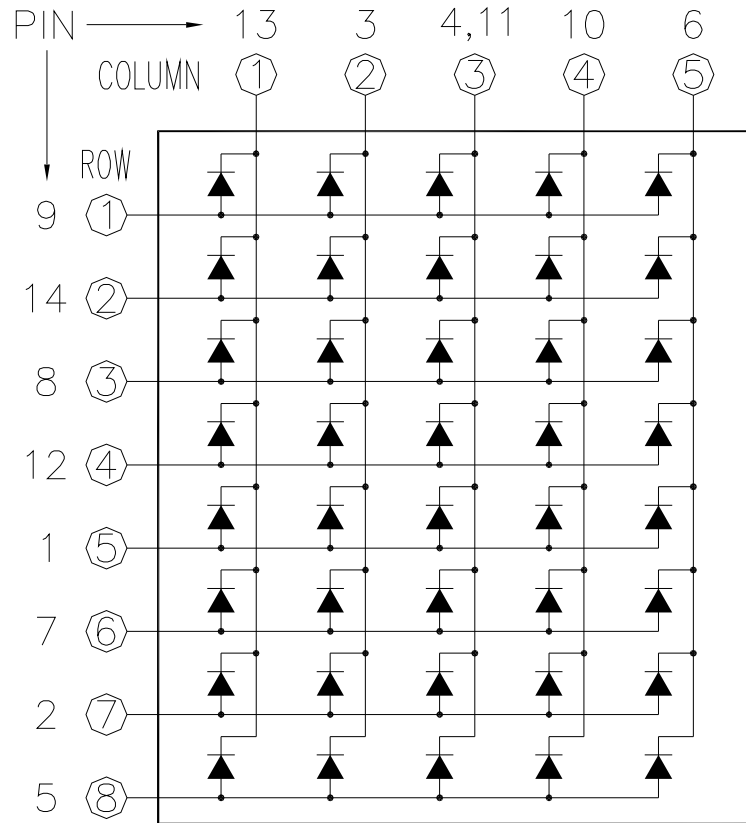

CSM-58211		CSM-58221		CSM-58221			
PIN NO.	FUNCTION	PIN NO.	FUNCTION	PIN NO.	FUNCTION		
1	Cathode Row 5	8	Cathode Row 3	1	Anode Row 5	8	Anode Row 3
2	Cathode Row 7	9	Cathode Row 1	2	Anode Row 7	9	Anode Row 1
3	Anode Column 2	10	Anode Column 4	3	Cathode Column 2	10	Cathode Column 4
4	Anode Column 3	11	Anode Column 3	4	Cathode Column 3	11	Cathode Column 3
5	Cathode Row 8	12	Cathode Row 4	5	Anode Row 8	12	Anode Row 4
6	Anode Column 5	13	Anode Column 1	6	Cathode Column 5	13	Cathode Column 1
7	Cathode Row 6	14	Cathode Row 2	7	Anode Row 6	14	Anode Row 2



Model No : CSM-58211/58221M9

■ Absolute Maximum Rating -

(Ta=25°C)

Parameter	Symbol	Rating	Unit
Power Dissipation Per Dice	<b>Pd</b>	70	mW
Continuous Forward Current Per Dice	<b>IAF</b>	25	mA
Peak Current Per Dice(duty cycle 1/10, 1kHz)	<b>IPF</b>	90	mA
Derating Linear From 25°C Per Dice	-	0.33	mA/°C
Reverse Voltage Per Dice	<b>VR</b>	5	V
Operating Temp.	<b>Topr</b>	-35 ~ +85	°C
Storage Temp.	<b>Tstg</b>	-35 ~ +85	°C
Solder temperature 1/16 inch below seating plane for 3 seconds at 260°C			

■ Electro-optical Characteristics -

(Ta=25°C)

Parameter	Symbol	Min.	Typ.	Max.	Unit	Condition
Forward Voltage Per Segment	<b>VF</b>	-	2.1	2.8	V	IF=20mA
Luminous Intensity Per Segment	<b>Iv</b>	-	18	-	mcd	IF=10mA
Peak Emission Wavelength	$\lambda_p$	-	572	-	nm	IF=20mA
Dominant Wavelength	$\lambda_d$	-	570	-	nm	IF=20mA
Spectrum Radiation Bandwidth	$\Delta \lambda$	-	20	-	nm	IF=20mA
Reverse Current	<b>IR</b>	-	-	100	$\mu A$	VR=5V
Luminous Intensity Matching Ratio	<b>IV-m</b>	-	-	2:1	-	IF=10mA



Model No : CSM-58211/58221M9

■ Typical Electrical / Optical Characteristics Curves -

(Ta = 25°C Unless Otherwise Noted)

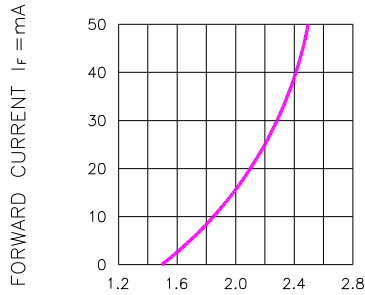

Fig.1 FORWARD CURRENT VS. FORWARD VOLTAGE

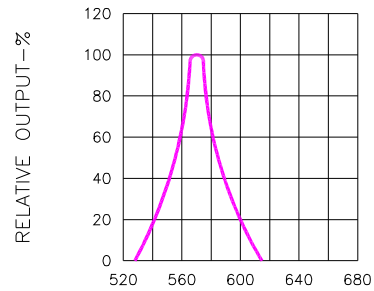

Fig.2 SPECTRAL RESPONSE

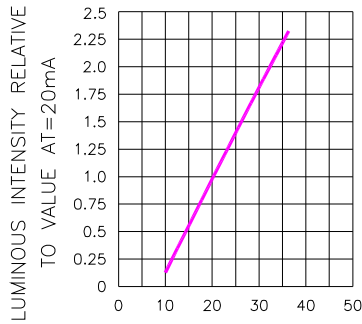

Fig.3 RELATIVE LUMINOUS INTENSITY VS. FORWARD CURRENT

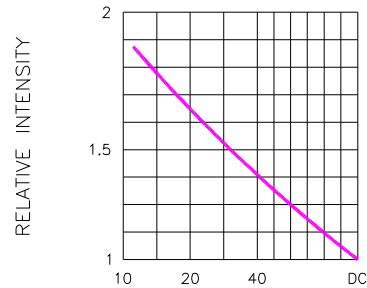

Fig.5 LUMINOUS INTENSITY VS. DUTY CYCLE

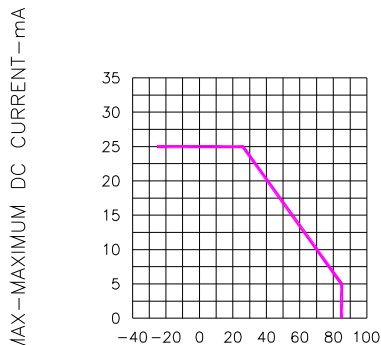

Fig.4 MAXIMUM ALLOWABLE DC CURRENT PER SEGMENT VS. A FUNCTION OF AMBIENT TEMPERATURE

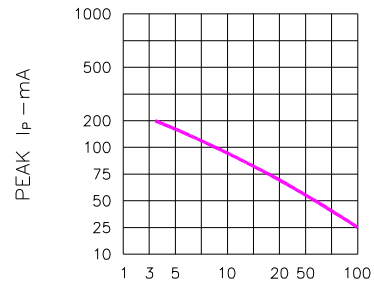

Fig.6 MAX PEAK CURRENT VS. DUTY CYCLE % (REFRESH RATE f=1 KHz)