

ISOLATED DC/DC CONVERTERS

18 Vdc - 75 Vdc Input 5 Vdc / 8 A Output, 1/16 Brick



May 24, 2011

Bel Power Inc., a subsidiary of Bel Fuse Inc.

0RSB-40U05B RoHS Compliant PRELIMINARY Rev.A

Features

- Isolated
- Fixed Frequency
- High Efficiency
- High Power Density
- Low Cost
- Output Voltage Trim
- Basic Insulation
- Class 2, Category 2, Isolated DC/DC Converter (refer to IPC-9592)
- UL60950-1 Recognized (UL/cUL) (Pending)
- Input Under Voltage Lockout
- Output Over Voltage Shutdown
- OCP/SCP
- Over Temperature Protection
- Positive/Negative Remote Sense
- Remote On/Off
- Through Hole

Applications

- Networking
- Computers and peripherals
- Telecommunications

Description

The 0RSB-40U05B is an isolated dc/dc converter that operates from a nominal 24 Vdc or 48 Vdc source. The unit will provide up to 40 W of output power from an 18-75 Vdc wide input range. The unit is designed to be highly efficient and low cost. Features include remote on/off, over current protection and under voltage lockout. This converter is provided in an industry standard sixteenth brick package.

Part Selection

Output Voltage	Input Voltage	Max. Output Current	Max. Output Power	Typical Efficiency	Model Number Active Low
5.0 Vdc	18 Vdc - 75 Vdc	8 A	40 W	87%	0RSB-40U05B

Note: Add "G" suffix at the end of the model number to indicate Tray Packaging.

Part Number Explanation

0 R SB - 40 U 05 B
1 2 3 4 5 6 7

- 1---Through hole
- 2---RoHS 6, change "R" to "7" means RoHS 5
- 3---Series name, 1/16 Brick
- 4---Series code
- 5---Input range (18-75V)
- 6---Output voltage (5V)
- 7---Enable, active low, pin length is 0.11 inch

ISOLATED DC/DC CONVERTERS

18 Vdc - 75 Vdc Input 5 Vdc / 8 A Output, 1/16 Brick



May 24, 2011

Bel Power Inc., a subsidiary of Bel Fuse Inc.

Absolute Maximum Ratings

Parameter	Min	Typ	Max	Unit	Notes
Input Voltage (continuous)	-0.3	-	80	V	
Input Transient Voltage	-	-	100	V	100mS maximum
Remote On/Off	-0.3	-	18	V	
I/O Isolation Voltage	-	-	1500	V	
Ambient Temperature	-40	-	85	°C	
Storage Temperature	-55	-	125	°C	

Note: Ratings used beyond the maximum ratings may cause a reliability degradation of the converter or may permanently damage the device.

Input Specifications

Parameter	Min	Typ	Max	Unit	Notes
Input Voltage	18	48	75	V	
Input Current (full load)	-	-	3.5	A	
Input Current (no load)	-	60	120	mA	
Remote Off Input Current	-	1	3	mA	
Input Reflected Ripple Current (pk-pk)	-	20	50	mA	With simulated source impedance of 10uH, 5Hz to 20MHz. Use a 100uF/100V electrolytic capacitor with ESR=1 ohm max, at 200KHz@25°C.
Input Reflected Ripple Current (rms)	-	3	7	mA	
Input Over Voltage Lockout	78	-	82	V	
I ² t Inrush Current Transient	-	0.01	0.02	A ² s	
Turn-on Voltage Threshold	16.6	17.2	17.8	V	
Turn-off Voltage Threshold	16.2	16.8	17.4	V	

Note: All specifications are typical at nominal input, full load at 25 °C unless otherwise stated.

Output Specifications

Parameter	Min	Typ	Max	Unit	Notes
Output Voltage Set Point	4.925	5.000	5.075	V	V _{in} =48 V; I _o =50% load
Load Regulation	-	±4	±9	mV	
Line Regulation	-	±4	±9	mV	
Regulation Over Temperature(-40 °C to +85 °C)	-	±15	±30	mV	
Total Regulation	-	±23	±48	mV	
Ripple and Noise (pk-pk)	-	70	120	mV	0-20MHz BW, with a 1µF ceramic capacitor and a 10uF Tantalum cap at output.
Ripple and Noise (rms)	-	25	50	mV	
Output Current Range	0	-	8	A	

ISOLATED DC/DC CONVERTERS

18 Vdc - 75 Vdc Input 5 Vdc / 8 A Output, 1/16 Brick



May 24, 2011

Bel Power Inc., a subsidiary of Bel Fuse Inc.

Output Specifications (continued)

Parameter		Min	Typ	Max	Unit	Notes	
Output DC Current Limit		8.8	10	12.5	A		
Short Circuit Surge Transient		-	0.5	1	A ² s	Hiccup mode, auto recovery.	
Turn on Time		-	25	50	mS		
Overshoot at Turn on		-	0	5	%		
Output Capacitance		150	-	2200	uF		
Transient Response							
25% ~ 50% Max Load	Overshoot	Vo=5 V	-	250	350	mV	di/dt=0.1A/us, Vin=48Vdc, Ta=25°C, with a 1µF ceramic capacitor and a 10uF Tantalum cap at output.
	Settling Time		-	100	200	mS	
50% ~ 25% Max Load	Overshoot		-	250	350	mV	
	Settling Time		-	100	200	mS	

Note: All specifications are typical at nominal input, full load at 25°C unless otherwise stated.

General Specifications

Parameter	Min	Typ	Max	Unit	Notes
Efficiency	85	87	-	%	Vin=48 V, full load
Switching Frequency	-	500	-	KHz	
Over Temperature Protection	-	125	-	°C	The OTP threshold is set at 125°C in non-latch mode, and the module will restart automatically when temperature falls down to 115°C.
Output Voltage Trim Range	90	-	110	%	
Over Voltage Protection	-	130	160	%	This voltage is achieved by trimming up output slowly.
Dimensions Inches (L x W x H) Millimeters (L x W x H)	1.30 x 0.90 x 0.46 33.02 x 22.86 x 11.69			-	
Weight	-	14	-	g	
Isolation characteristics					
Input to Output	-	-	1500	V	
Isolation Resistance	10M	-	-	Ohm	
Isolation Capacitance	-	3900	-	pF	

Note: All specifications are typical at 25 °C unless otherwise stated.

ISOLATED DC/DC CONVERTERS

18 Vdc - 75 Vdc Input 5 Vdc / 8 A Output, 1/16 Brick



May 24, 2011

Bel Power Inc., a subsidiary of Bel Fuse Inc.

Efficiency Data

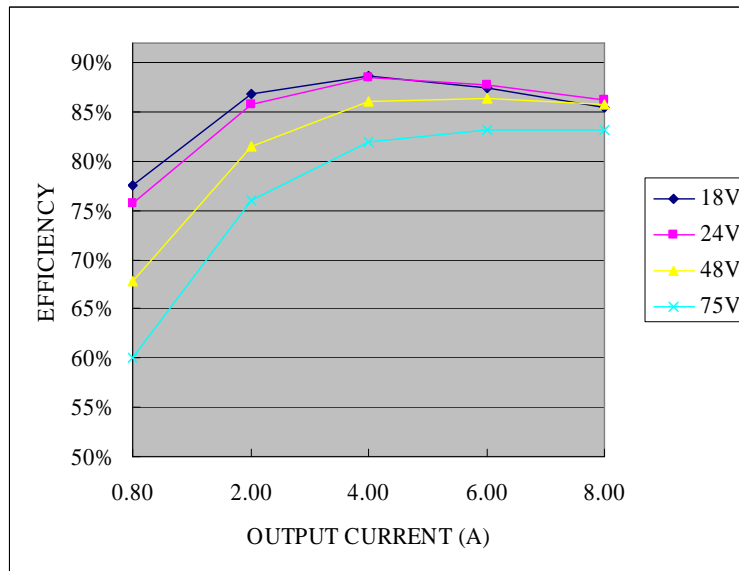

Thermal Derating Curve

Maximum junction temperature of semiconductors derated to 120 degree C.



ISOLATED DC/DC CONVERTERS

18 Vdc - 75 Vdc Input 5 Vdc / 8 A Output, 1/16 Brick



May 24, 2011

Bel Power Inc., a subsidiary of Bel Fuse Inc.

Thermal Derating Curve (continued)

Derating curve under normal input

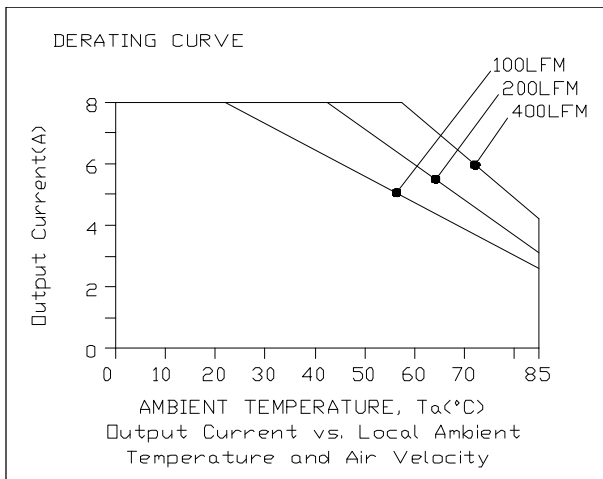

Vin= 24Vdc

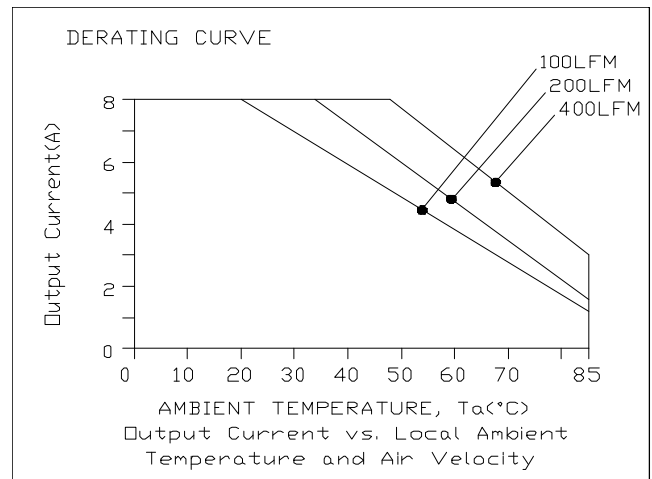

Vin= 48Vdc

The OTP is achieved by thermistor R65 and the threshold is set at 120°C in non-latch mode; the hottest component Q5 reaches 125°C with 100LFM air flow correspondingly. It will restart automatically when the temperature falls down to 115°C. The protecting point will be varied a little under different conditions (air flow, ambient temperature, input voltage, load...).

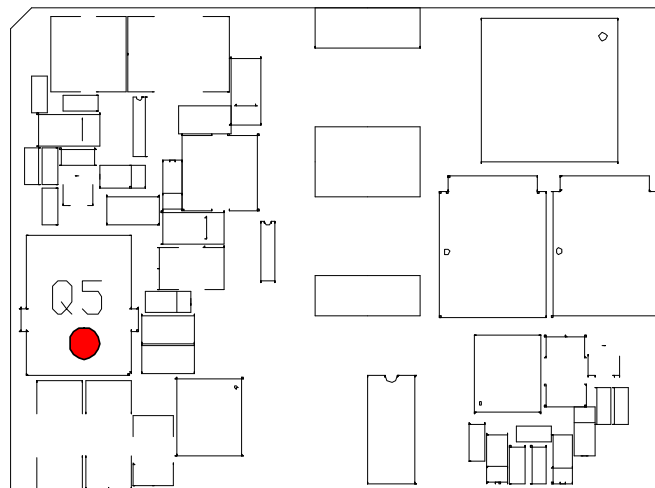

Temperature reference points on top side

ISOLATED DC/DC CONVERTERS

18 Vdc - 75 Vdc Input 5 Vdc / 8 A Output, 1/16 Brick



May 24, 2011

Bel Power Inc., a subsidiary of Bel Fuse Inc.

Ripple and Noise Waveform

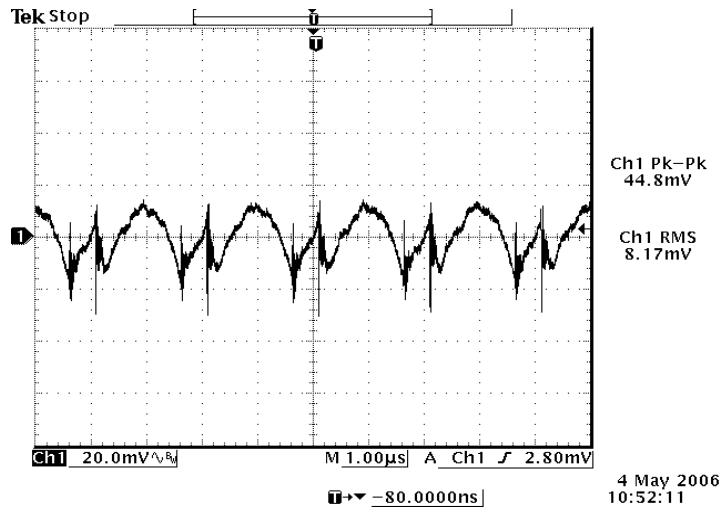

48Vdc input, 5Vdc output

Note: Ripple and noise at full load, with a 1uF ceramic cap and a 10 uF Tantalum cap at output, Ta=25 deg C.

Transient Response Waveforms

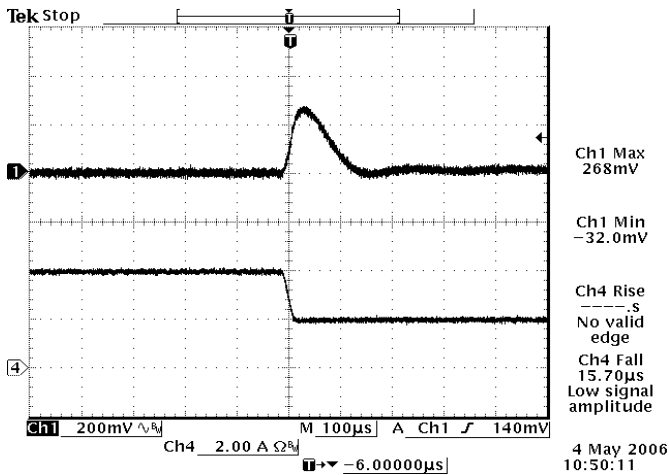

Vout= 5V 50%-25% Load Transients

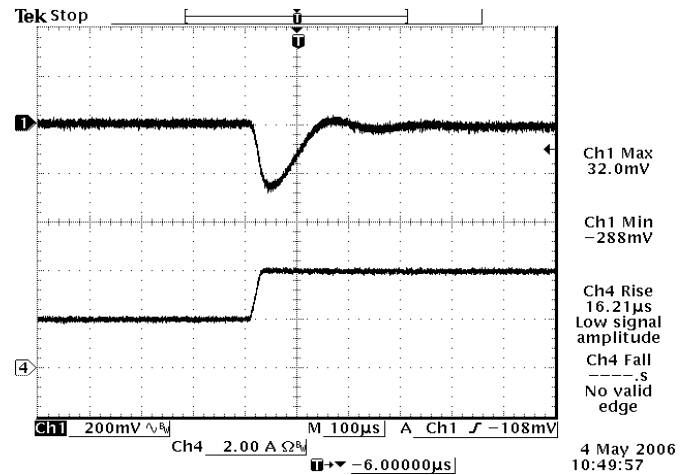

Vout= 5V 25%-50% Load Transients

Note: Transient Response at di/dt=0.1A/uS, Vin=48Vdc, with an External 100uF Tantalum Cap and 1uF Ceramic Cap, Ta=25 deg C.

ISOLATED DC/DC CONVERTERS

18 Vdc - 75 Vdc Input 5 Vdc / 8 A Output, 1/16 Brick



May 24, 2011

Bel Power Inc., a subsidiary of Bel Fuse Inc.

Startup

Rise time

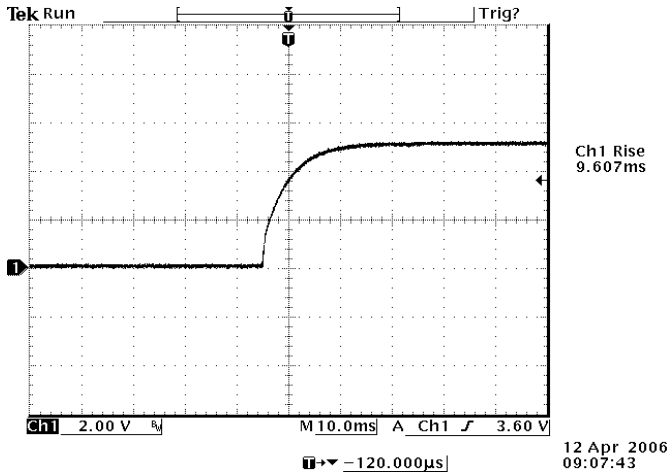

Vin=48V, Vo=5V, 100% Load

Start up time

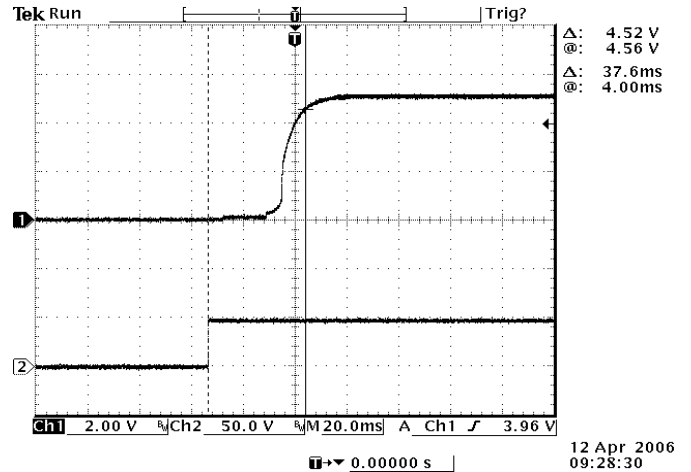

Ch1: Vo
Ch2: Vin
Vin=48V, Vo=5V, 100% Load

Note: Start up waveform, tested with an External 220uF Tantalum Cap and 1uF Ceramic Cap, Ta=25 deg C.

Remote On/Off

Parameter	Min	Typ	Max	Unit	Notes
Signal Low (Unit On)	-0.3	-	0.8	V	Remote On/Off pin is open, the module is off.
Signal High (Unit Off)					
Current Sink	0	-	1	mA	

Recommended remote on/off circuit for active low

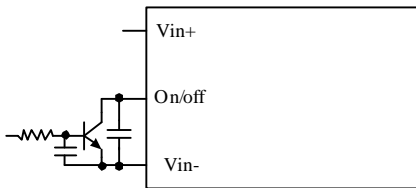

Control with open collector/drain circuit

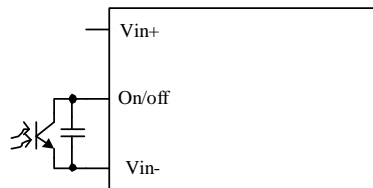

Control with photocoupler circuit

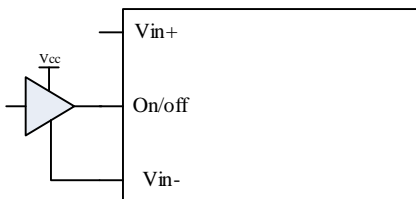

Control with logic circuit

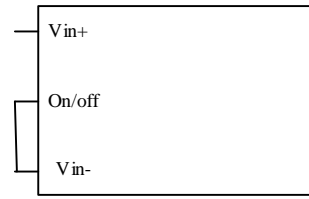

Permanently on

ISOLATED DC/DC CONVERTERS

18 Vdc - 75 Vdc Input 5 Vdc / 8 A Output, 1/16 Brick



May 24, 2011

Bel Power Inc., a subsidiary of Bel Fuse Inc.

Output Trim Equations

Equations for calculating the trim resistor are shown below (Unit: kΩ). The Trim Down resistor should be connected between the Trim pin and Ground pin. The Trim Up resistor should be connected between the Trim pin and the Vout. Only one of the resistors should be used for any given application.

$$R_{trimdown} = \frac{511}{|\delta|} - 10.22 [k\Omega]$$

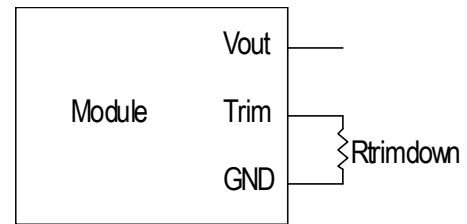

$$R_{trimup} = \frac{(100 + \delta) \cdot V_o \cdot 5.11 - 626}{1.225 \cdot \delta} - 10.22 [k\Omega]$$

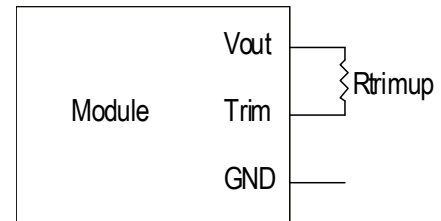

Note:

$$\delta = \frac{(V_o_{req} - V_o)}{V_o} \times 100 [\%]$$

V_o_{req} = Desired (trimmed) output voltage [V]

Output voltage V_o = 5.002V

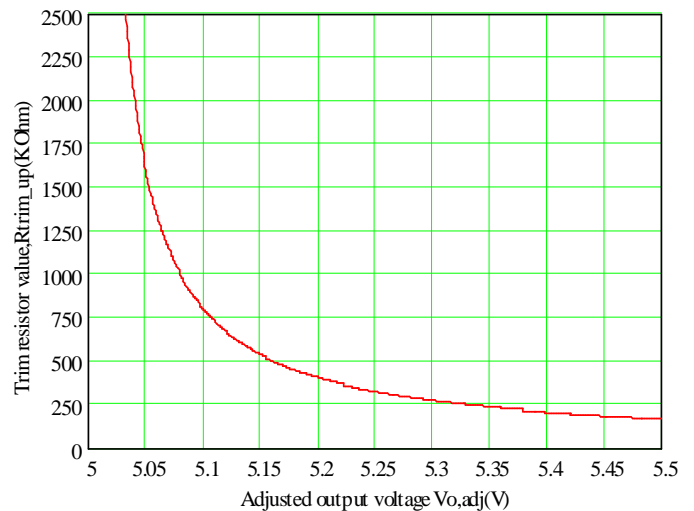
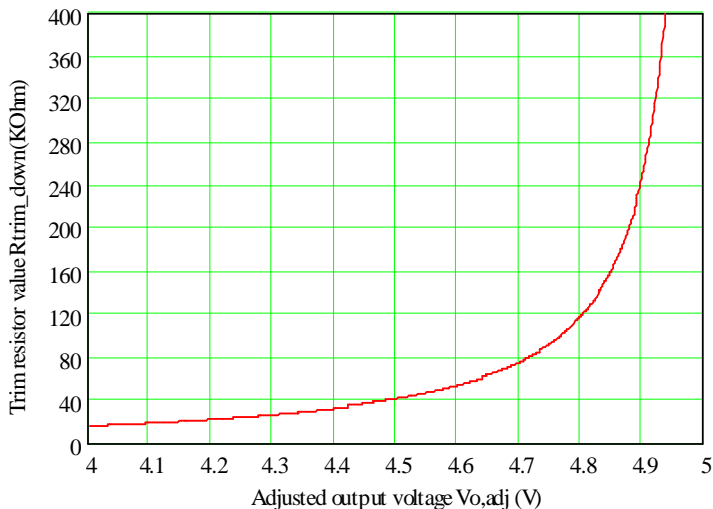

ISOLATED DC/DC CONVERTERS

18 Vdc - 75 Vdc Input 5 Vdc / 8 A Output, 1/16 Brick



May 24, 2011

Bel Power Inc., a subsidiary of Bel Fuse Inc.

Remote Sense

This module has remote sense compensation feature. It can minimize the effects of resistance between module's output and load in system layout and facilitates accurate voltage regulation at load terminals or other selected point.

1. The remote sense lines carries very little current and hence do not require a large cross-sectional area.
2. This module compensates for a maximum drop of 10% of the nominal output voltage.
3. If the unit is already trimmed up, the available remote sense compensation range should be correspondingly reduced. The total voltage increased by trim and remote sense should not exceed 10% of the nominal output voltage.
4. When using remote sense compensation, all the resistance, parasitic inductance and capacitance of the system are incorporated within the feedback loop of this module. It can make an effect on the module's compensation, affecting the stability and dynamic response. A 0.1 μ F ceramic capacitor can be connected at the point of load to de-couple noise on the sense wires.
5. Recommend the connection of remote sense compensation as below figure. There are a resistor RS+ (51 ohm) from Vo+ to Sense+ and a resistor RS- (10 ohm) from Vo- to Sense- inside of this module.

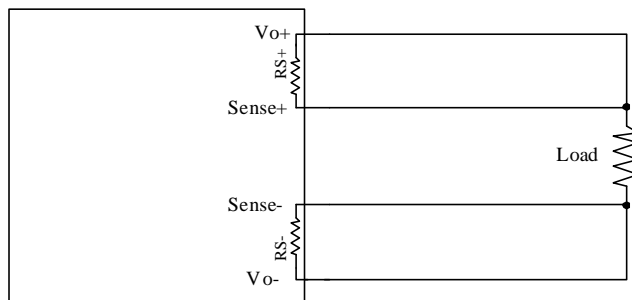

6. If not using remote sense compensation, please connect sense directly to output at module's pin, that is, connect sense+ to Vo+ and sense- to Vo- at module's pin, the shorter the better. See below figure.

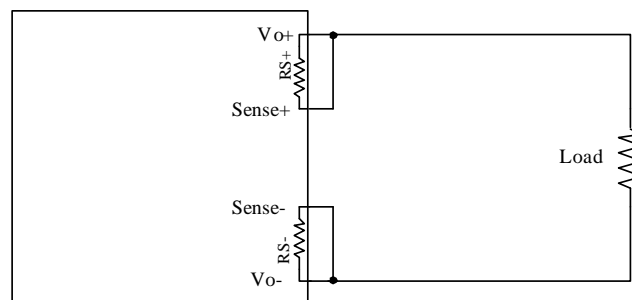

ISOLATED DC/DC CONVERTERS

18 Vdc - 75 Vdc Input 5 Vdc / 8 A Output, 1/16 Brick



May 24, 2011

Bel Power Inc., a subsidiary of Bel Fuse Inc.

Mechanical Outline

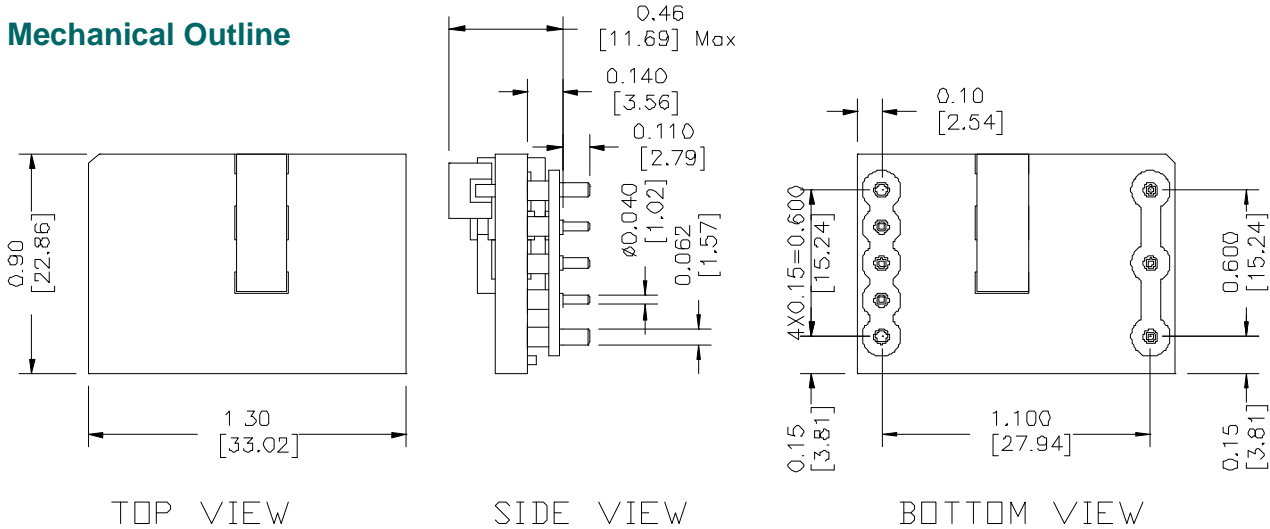

UNIT : INCH [mm]

RECOMMENDED PCB PAD LAYOUT

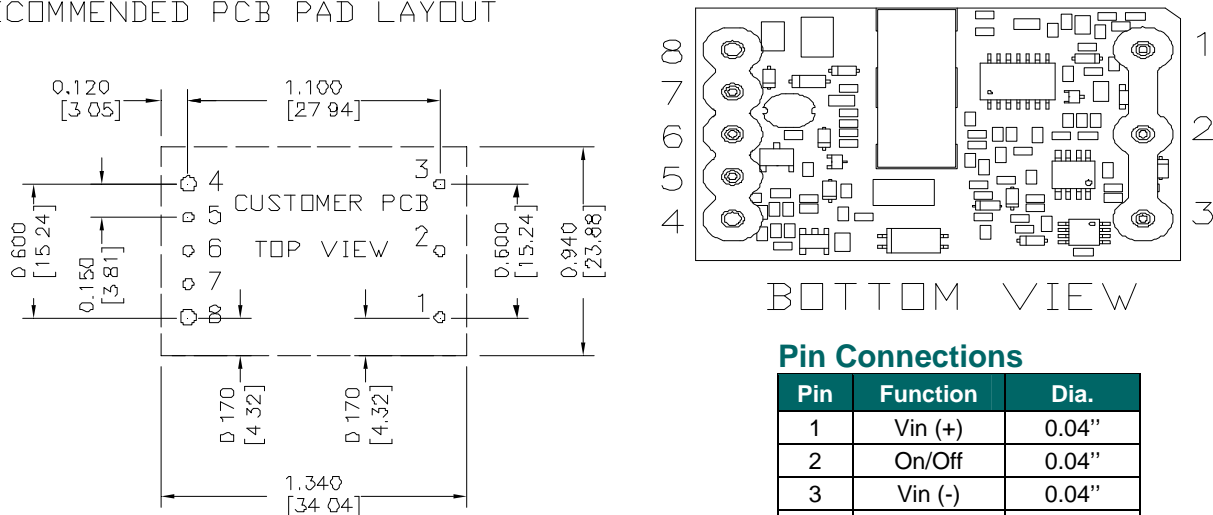

HOLE SIZE: 1-3, 5-7 $\phi 0.047$ [1.19],
 4,8 $\phi 0.07$ [1.78]
 PAD SIZE: 1-3, 5-7 $\phi 0.08$ [2.03]
 4,8 $\phi 0.10$ [2.54]

Pin Connections

Pin	Function	Dia.
1	Vin (+)	0.04"
2	On/Off	0.04"
3	Vin (-)	0.04"
4	Vout (-)	0.062"
5	SENSE(-)	0.04"
6	Trim	0.04"
7	SENSE(+)	0.04"
8	Vout (+)	0.062"

Note: This module is recommended and compatible with Pb-Free Wave Soldering and must be soldered using a peak solder temperature of no more than 260 °C for less than 5 seconds.

Note:

- 1) All Pins: Material - Copper Alloy;
Finish – 3 micro inches minimum Gold over 50 micro inches minimum Nickel plate.
- 2) Undimensioned components are shown for visual reference only.
- 3) All dimensions in inches (mm); Tolerances: x.xx +/-0.02 in. (x.x +/-0.5mm) x.xxx +/-0.010 in. (x.xx +/-0.25mm).

ISOLATED DC/DC CONVERTERS

18 Vdc - 75 Vdc Input 5 Vdc / 8 A Output, 1/16 Brick



May 24, 2011

Bel Power Inc., a subsidiary of Bel Fuse Inc.

Revision History

Date	Revision	Changes Detail	Approval
2011-05-24	PA	First release	JZ Wang

RoHS Compliance

Complies with the European Directive 2002/95/EC, calling for the elimination of lead and other hazardous substances from electronic products.



©2011 Bel Fuse Inc. Specifications subject to change without notice. 052411

11

CORPORATE

Bel Fuse Inc.
206 Van Vorst Street
Jersey City, NJ 07302
Tel 201-432-0463
Fax 201-432-9542
www.belfuse.com

FAR EAST

Bel Fuse Ltd.
8F/ 8 Luk Hop Street
San Po Kong
Kowloon, Hong Kong
Tel 852-2328-5515
Fax 852-2352-3706
www.belfuse.com

EUROPE

Bel Fuse Europe Ltd.
Preston Technology Management Centre
Marsh Lane, Suite G7, Preston
Lancashire, PR1 8UD, U.K.
Tel 44-1772-556601
Fax 44-1772-888366
www.belfuse.com