

Transistors

ATR • ATV

Approximately the same size as the TO-92 with up to 1 W power capability.
Taped type for automated placement or bulk packaging available.

Application	Package		V _{CEO} (V) *V _{CEs} **V _{CER}	I _c (A)	I _c Max. (A)	P _c (mW) (T _a = 25°C)	h _{FE}	h _{FE} Ranking code	V _{CE} (V)	I _c (mA)	Internal circuit	
	ATR	ATV										
	Part No.											
Low Noise	2SA937AMLN	—	-50	-0.15	—	300	180~560	R S	-6	-1	—	
	2SC2021MLN	—	40	0.15	—	300	390~820	E	6	1	—	
	2SA937AM	2SA1547A	-50	-0.15	—	300	82~390	P Q R	-6	-1	—	
Pre Amp	2SC2021M	2SC4010	40	0.15	—	300	390~820	E	6	1	—	
	2SC4776M	2SC4778	25	0.1	0.2	400	180~560	R S	6	1	—	
Driver	2SA874M	2SA1548	-32	-0.5	—	300	82~390	P Q R	-3	-100	—	
	2SB909M	2SB1237	-32	-1	—	1000*	82~390	P Q R	-3	-100	—	
	2SB910M	2SB1238	-80	-0.7	—	1000*	82~390	P Q R	-3	-100	—	
	2SB911M	2SB1240	-32	-2	-3	1000*	82~390	P Q R	-3	-500	—	
	2SB1042M	2SB1241	-80	-1	—	1000*	82~390	P Q R	-3	-100	—	
	2SB1044M	2SB1242	-50	-1	—	1000*	82~390	P Q R	-3	-100	—	
	2SB1066M	2SB1243	-50	-3	—	1000*	56~390	N P Q R	-3	-500	—	
	2SB1130AM	2SB1236A	-160	-1.5	-3	1000*	56~270	N P Q	-5	-100	—	
	2SB1130M	2SB1236	-120	-1.5	-3	1000*	56~390	N P Q R	-5	-100	—	
	2SC1652M	2SC4016	32	0.5	—	400	82~390	P Q R	3	100	—	
	2SD1225M	2SD1858	32	1	—	1000*	82~390	P Q R	3	100	—	
	2SD1226M	2SD1859	80	0.7	—	1000*	82~390	P Q R	3	100	—	
	2SD1227M	2SD1862	32	2	2.5	1000*	82~390	P Q R	3	500	—	
	2SD1228M	2SD1860	50	0.5	—	600	82~390	P Q R	3	100	—	
	2SD1293M	2SD1863	80	1	2	1000*	82~390	P Q R	3	500	—	
	2SD1507M	2SD1864	50	3	—	1000*	82~390	P Q R	3	500	—	
	2SD1665AM	2SD1857A	160	1.5	3	1000*	56~270	N P Q	5	100	—	
	2SD1665M	2SD1857	120	1.5	3	1000*	56~390	N P Q R	5	100	—	
	Storobo Flash	2SB1307M	2SB1326	-20	-5	-10	1000*	82~390	P Q R	-2	-500	—
		2SD1962M	2SD2097	20	5	10	1000*	120~560	Q R S	2	500	—
Low V _{CE(sat)}	2SB1485M	2SB1443	-50	-2	-5	1000*	82~270	P Q	-2	-500	—	
	2SD1489M	2SD1865	15	1	—	600	120~560	Q R S	3	100	—	
	—	2SD2264	20	3	5	1000*	120~560	Q R S	2	100	—	
Chroma	2SD2197M	2SD2279	50	2	5	1000*	82~270	P Q	2	500	—	
	2SC3270M	2SC4015	300	0.1	—	1000*	39~180	M N P	10	10	—	
High h _{FE}	—	2SB1460	-20	-2	-3	1000*	270~820	S E	-6	-500	—	
High h _{FE}	2SD2145M	2SD2192	20	0.5	1	400	560~2700	U V W	3	10	—	
High V _{EB0}	2SD2313M	2SD2315	50	0.15	0.2	400	580~2700	U V W	5	1	—	
Darlington	2SA790M	2SA1549	-32*	-0.3	-1.5	300	5k~	—	-5	-100	Fig. 1	
	2SB1076M	2SB1239	-40**	-2	—	1000*	1k~	A	-3	-500	Fig. 1	
	2SC1545M	2SC4017	32*	0.3	1.5	300	5k~	—	5	100	Fig. 2	
	—	2SC5080	90 ± 10	1	2	1000	1k~5k	M N	3	500	Fig. 4	
	2SD1536M	2SD1861	40**	2	—	1000*	1k~	A	3	500	Fig. 2	
	2SD1660M	2SD1867	100	2	—	1000*	1k~10k	—	2	1000	Fig. 3	
High Voltage SW	2SD1861M	2SD1866	80 ± 10	2	—	1000*	1k~10k	—	2	1000	Fig. 4	
	—	2SA1776	-400	-0.5	-1	1000*	82~270	P Q	-5	-50	—	
	—	2SA1920	-600	-0.1	-0.2	1000	56~270	N P Q	10	10	—	
2SC4295M	2SC4620	400	0.1	—	1000*	56~270	N P Q	10	10	—		

Note: *PC board (collector's copper foil area, 1cm² or over; PC board thickness, 1.7mm)

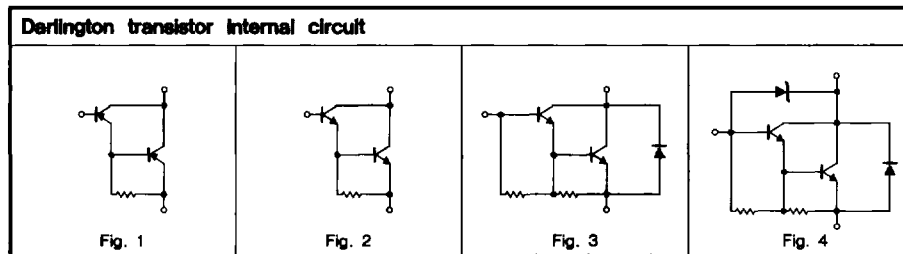

ATR • ATV High frequency type

Application	Package		V _{CEO} (V)	I _c (mA)	f _t (MHz)	C _{ob} (pF)	h _{FE}	h _{FE} Ranking code	V _{CE} (V)	I _c (mA)	
	ATR	ATV									
	Part No.										
AM FM	FM IF AM RF	2SC3078M	2SC4012	32	100	230	1.8	56~180	N P	6	2
		2SC2063M	2SC4011	25	50	300	1.6	56~270	N P Q	6	1
VHF UHF	FM RF	2SC3079M	2SC4013	20	20	500	1.4	39~180	M N P	6	1
	Mix. Occ.	2SC5082M	2SC5083	25	50	650	1.6	27~180	L M N P	10	10
	TV Tuner Mix. Occ.	2SC3080M	2SC4014	19	50	1100	1.2	39~270	M N P Q	10	5

Product Designation

- When ordering, specify the type.
- Check each code against the tables shown below.
- Fill a space with the next character.

Special code

- Omit for standard product.
- Factory assigned for custom product.

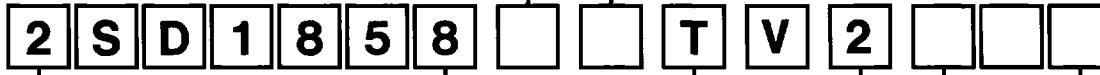

Part No.

Packaging

Package	Code	Package specifications	Quantity/Package (pcs)
ATR	—	Bulk	2,000
	C2	Tube	8,000 (80pcs×100)
ATV	TV2	Ammo box	2,500
	TV3		
	TV4		
	TV6		

hFE Ranking code

Input hFE rank signal display

- One rank preferred P
- Multiple rank preferred P R

(Min., Max. is displayed)

Code	hFE Range	Code	hFE Range
L	27~56	E	390~820
M	39~82	U	560~1200
N	56~120	V	820~1800
P	82~180	W	1200~2700
Q	120~270	A	1k~
R	180~390	B	5k~
S	270~560	C	10k~

(Unit : mm)

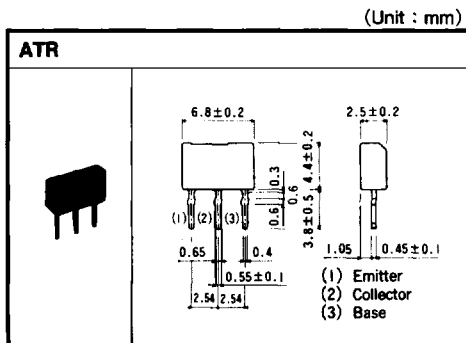

(Unit : mm)

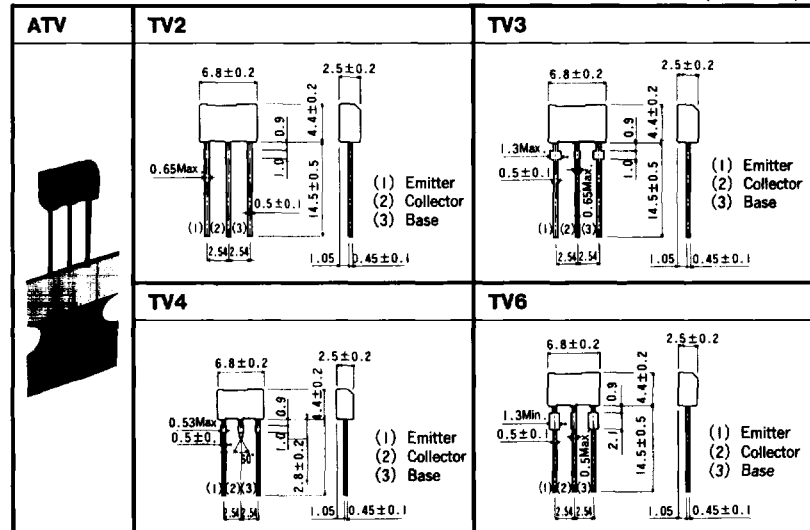

Packaging Specifications

(Unit : mm)

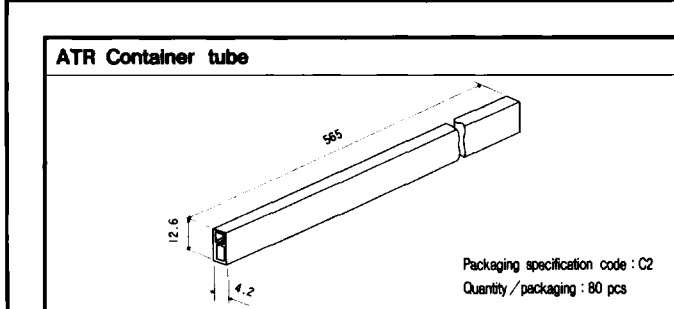
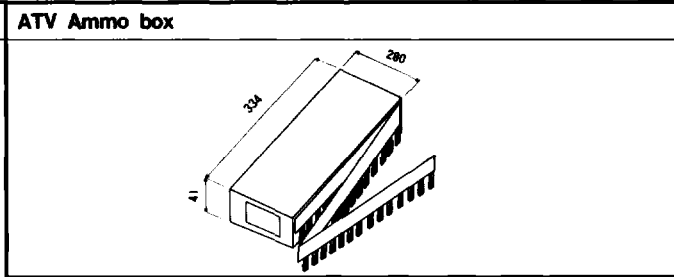
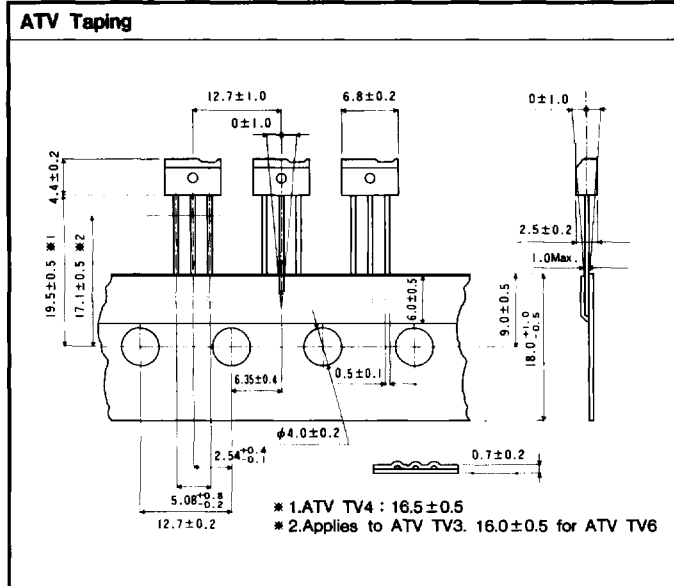

Transistors

Transistors

The Base and hFE ranking codes for Standard and Special Products are listed.