

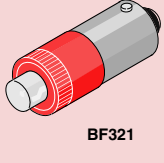
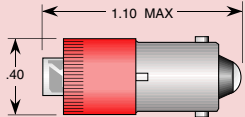
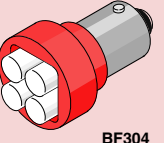
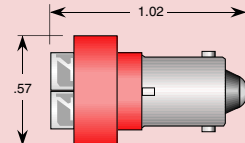
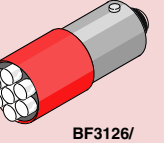
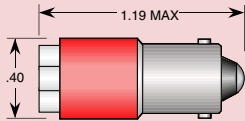
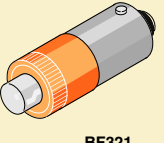
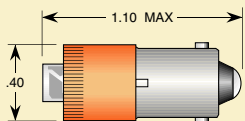
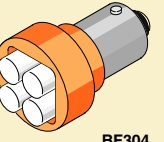
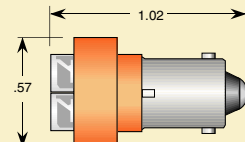
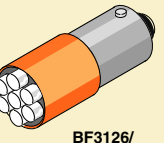
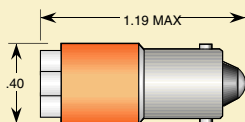

T3-1/4 (9mm) Miniature Based LED Lamps

Miniature Packages	Replaces Incandescent	Part Number	Electrical-Optical Characteristics (Ta = 25°C)			Angle of Illumination	Special Features
			Voltage V typ	Current mA typ	Intensity mcd		
660nm Ultra Red GaAlAs/GaAs  BF321 	T3-1/4 (9mm) Miniature Bayonet	6MB, 44, 47, 755	BF321-0UR-006B	5/6V	20	115	120° Center Contact Polarity B = Bipolar AC/DC A = AC only Replace BF321 With B321 for Narrow Beam (15°) 1.6K mcd/52 Ft.Cd @ 20mA
		12MB, 756	BF321-0UR-014B	12/14V	20	115	
		24MB,	BF321-0UR-024B	24V	20	115	
		313,757,1819,1829	BF321-0UR-028B	28V	20	115	
		48MB	BF321-0UR-048B	48V	12	65	
		60MB,1835	BF321-0UR-060B	60V	12	65	
		120MB, NE51H	BF321-0UR-120A	120VAC	10	50	
	BF321-0UR-130B	130V	8	40			
660nm Ultra Red GaAlAs/GaAs  BF304 	T3-1/4 (9mm) Miniature Bayonet LED Cluster	6MB, 44, 47, 755	BF304-0UR-006B	5/6V	80	460	120° Center Contact Polarity B = Bipolar AC/DC A = AC only Replace BF304 With B304 for Narrow Beam (15°) 6.4K mcd/208 Ft.Cd @ 20mA
		12MB, 756	BF304-0UR-014B	12/14V	40	460	
		24MB,	BF304-0UR-024B	24V	20	460	
		313,757,1819,1829	BF304-0UR-028B	28V	20	460	
		48MB	BF304-0UR-048B	48V	12	260	
		60MB,1835	BF304-0UR-060B	60V	12	260	
		120MB, NE51H	BF304-0UR-120A	120VAC	10	200	
	BF304-0UR-130B	130V	8	160			
660nm Ultra Red GaAlAs/GaAs  BF3126/ BF3127 	T3-1/4 (9mm) Miniature Bayonet LED Cluster	6MB, 44, 47, 755	BF3126-0UR-006B	5/6V	120	600	120° Center Contact Polarity B = Bipolar AC/DC A = AC only Replace BF3126/3127 With B3126/3127 for Narrow Beam (65°) 1.3K mcd/210 Ft.Cd @ 20mA
		12MB, 756	BF3126-0UR-014B	12/14V	40	600	
		24MB,	BF3127-0UR-024B	24V	20	700	
		313,757,1819,1829	BF3127-0UR-028B	28V	20	700	
		48MB	BF3127-0UR-048B	48V	12	230	
		60MB,1835	BF3127-0UR-060B	60V	12	230	
		120MB, NE51H	BF3127-0UR-120A	120VAC	10	160	
	BF3127-0UR-130B	130V	8	140			
612nm Super Orange InGaAlP  BF321 	T3-1/4 (9mm) Miniature Bayonet	6MB, 44, 47, 755	BF321-0UO-006B	5/6V	20	130	120° Center Contact Polarity B = Bipolar AC/DC A = AC only Replace BF321 With B321 for Narrow Beam (15°) 3.5 K mcd @ 20mA
		12MB, 756	BF321-0UO-014B	12/14V	20	130	
		24MB,	BF321-0UO-024B	24V	20	130	
		313,757,1819,1829	BF321-0UO-028B	28V	20	130	
		48MB	BF321-0UO-048B	48V	12	78	
		60MB,1835	BF321-0UO-060B	60V	12	78	
		120MB, NE51H	BF321-0UO-120A	120VAC	10	65	
	BF321-0UO-130B	130V	8	52			
612nm Super Orange InGaAlP  BF304 	T3-1/4 (9mm) Miniature Bayonet LED Cluster	6MB, 44, 47, 755	BF304-0UO-006B	5/6V	80	520	120° Center Contact Polarity B = Bipolar AC/DC A = AC only Replace BF304 With B304 for Narrow Beam (15°) 14 K mcd @ 20mA
		12MB, 756	BF304-0UO-014B	12/14V	40	520	
		24MB,	BF304-0UO-024B	24V	20	520	
		313,757,1819,1829	BF304-0UO-028B	28V	20	520	
		48MB	BF304-0UO-048B	48V	12	312	
		60MB,1835	BF304-0UO-060B	60V	12	312	
		120MB, NE51H	BF304-0UO-120A	120VAC	10	260	
	BF304-0UO-130B	130V	8	208			
612nm Super Orange InGaAlP  BF3126/ BF3127 	T3-1/4 (9mm) Miniature Bayonet LED Cluster	6MB, 44, 47, 755	BF3126-0UO-006B	5/6V	120	510	120° Center Contact Polarity B = Bipolar AC/DC A = AC only Replace BF3126/3127 With B3126/3127 for Medium Beam (50°) 2.45 K mcd @ 20mA
		12MB, 756	BF3126-0UO-014B	12/14V	40	510	
		24MB,	BF3127-0UO-024B	24V	20	595	
		313,757,1819,1829	BF3127-0UO-028B	28V	20	595	
		48MB	BF3127-0UO-048B	48V	12	357	
		60MB,1835	BF3127-0UO-060B	60V	12	357	
		120MB, NE51H	BF3127-0UO-120A	120VAC	10	298	
	BF3127-0UO-130B	130V	8	238			

All dimensions in inches. For millimeters multiply by 25.4

Log # 12ZH Rev 10-2000

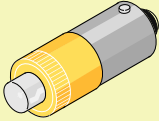
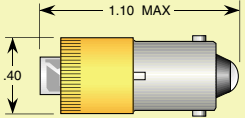
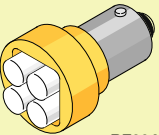
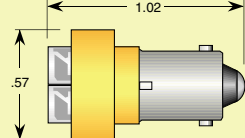
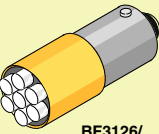
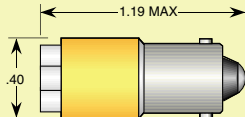
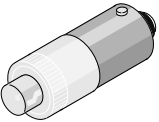
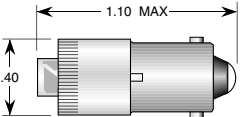
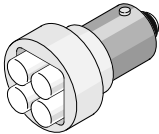
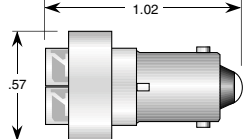
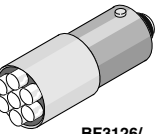
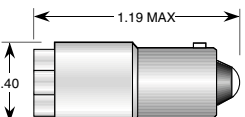

T3-1/4 (9mm) Miniature Based LED Lamps

Miniature Packages	Replaces Incandescent	Part Number	Electrical-Optical Characteristics (Ta = 25°C)			Angle of Illumination	Special Features
			Voltage V typ	Current mA typ	Intensity mcd		
595nm Super Yellow InGaAlP  BF321 	T3-1/4 (9mm) Miniature Bayonet	6MB, 44, 47, 755	BF321-0UY-006B	5/6V	20	116	120° Center Contact Polarity B = Bipolar AC/DC A = AC only Replace BF321 With B321 for Narrow Beam (15°) 3.2K mcd @ 20mA
		12MB, 756	BF321-0UY-014B	12/14V	20	116	
		24MB,	BF321-0UY-024B	24V	20	116	
		313,757,1819,1829	BF321-0UY-028B	28V	20	116	
		48MB	BF321-0UY-048B	48V	12	54	
		60MB,1835	BF321-0UY-060B	60V	12	54	
		120MB, NE51H	BF321-0UY-120A	120VAC	10	39	
	BF321-0UY-130B	130V	8	24			
595nm Super Yellow InGaAlP  BF304 	T3-1/4 (9mm) Miniature Bayonet LED Cluster	6MB, 44, 47, 755	BF304-0UY-006B	5/6V	80	464	120° Center Contact Polarity B = Bipolar AC/DC A = AC only Replace BF304 With B304 for Narrow Beam (15°) 12.8K mcd @ 20mA
		12MB, 756	BF304-0UY-014B	12/14V	40	464	
		24MB,	BF304-0UY-024B	24V	20	464	
		313,757,1819,1829	BF304-0UY-028B	28V	20	464	
		48MB	BF304-0UY-048B	48V	12	216	
		60MB,1835	BF304-0UY-060B	60V	12	216	
		120MB, NE51H	BF304-0UY-120A	120VAC	10	156	
	BF304-0UY-130B	130V	8	96			
595nm Super Yellow InGaAlP  BF3126/ BF3127 	T3-1/4 (9mm) Miniature Bayonet LED Cluster	6MB, 44, 47, 755	BF3126-0UY-006B	5/6V	120	192	120° Center Contact Polarity B = Bipolar AC/DC A = AC only Replace BF3126/3127 With B3126/3127 for Medium Beam (50°) 7K mcd @ 20mA
		12MB, 756	BF3126-0UY-014B	12/14V	40	192	
		24MB,	BF3127-0UY-024B	24V	20	224	
		313,757,1819,1829	BF3127-0UY-028B	28V	20	224	
		48MB	BF3127-0UY-048B	48V	12	105	
		60MB,1835	BF3127-0UY-060B	60V	12	105	
		120MB, NE51H	BF3127-0UY-120A	120VAC	10	87	
	BF3127-0UY-130B	130V	8	70			
8000K Cool White SiC/GaN  BF321 	T3-1/4 (9mm) Miniature Bayonet	6MB, 44, 47, 755	BF321-0CW-006B	5/6V	15	160	120° Center Contact Polarity B = Bipolar AC/DC A = AC only Replace BF321 With B321 for Std. Beam (50°)
		12MB, 756	BF321-0CW-014B	12/14V	15	160	
		24MB,	BF321-0CW-024B	24V	15	160	
		313,757,1819,1829	BF321-0CW-028B	28V	15	160	
		48MB	BF321-0CW-048B	48V	12	128	
		60MB,1835	BF321-0CW-060B	60V	12	128	
		120MB, NE51H	BF321-0CW-120A	120VAC	10	106	
	BF321-0CW-130B	130V	8	85			
8000K Cool White SiC/GaN  BF304 	T3-1/4 (9mm) Miniature Bayonet LED Cluster	6MB, 44, 47, 755	BF304-0CW-006B	5/6V	60	640	120° Center Contact Polarity B = Bipolar AC/DC A = AC only Replace BF304 With B304 for Std. Beam (50°)
		12MB, 756	BF304-0CW-014B	12/14V	30	640	
		24MB,	BF304-0CW-024B	24V	15	640	
		313,757,1819,1829	BF304-0CW-028B	28V	15	640	
		48MB	BF304-0CW-48B	48V	12	512	
		60MB,1835	BF304-0CW-60B	60V	12	512	
		120MB, NE51H	BF304-0CW-120A	120VAC	10	424	
	BF304-0CW-130B	130V	8	340			
8000K Cool White SiC/GaN  BF3126/ BF3127 	T3-1/4 (9mm) Miniature Bayonet LED Cluster	6MB, 44, 47, 755	BF3126-0CW-006B	5/6V	90	900	120° Center Contact Polarity B = Bipolar AC/DC A = AC only Replace BF3126/3127 With B3126/3127 for Std. Beam (50°)
		12MB, 756	BF3126-0CW-014B	12/14V	30	900	
		24MB,	BF3126-0CW-024B	24V	15	900	
		313,757,1819,1829	BF3127-0CW-028B	28V	15	1050	
		48MB	BF3127-0CW-048B	48V	12	840	
		60MB,1835	BF3127-0CW-060B	60V	12	840	
		120MB, NE51H	BF3127-0CW-120A	120VAC	10	700	
	BF3127-0CW-130B	130V	8	560			

All dimensions in inches. For millimeters multiply by 25.4

Log # 122J Rev 10-2000

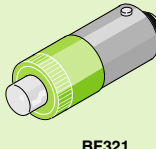
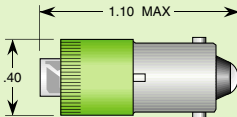
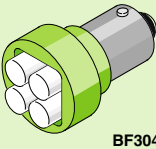
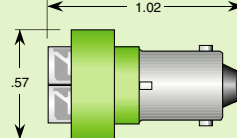
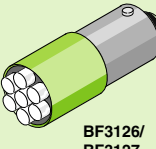
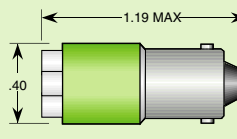
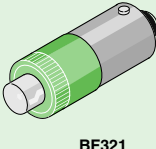
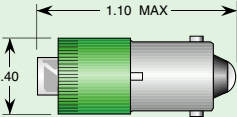
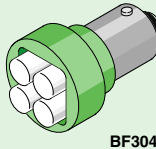
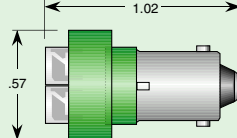
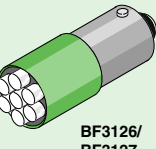
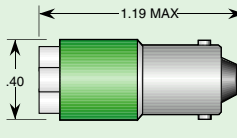

T3-1/4 (9mm) Miniature Based LED Lamps

Miniature Packages	Replaces Incandescent	Part Number	Electrical-Optical Characteristics (Ta = 25°C)			Angle of Illumination	Special Features
			Voltage V typ	Current mA typ	Intensity mcd		
570nm Lime Green InGaAlP  BF321 	T3-1/4 (9mm) Miniature Bayonet	6MB, 44, 47, 755	BF321-0UG-006B	5/6V	20	58	120° Center Contact Polarity B = Bipolar AC/DC A = AC only Replace BF321 With B321 for Narrow Beam (12-15°) 1K mcd @ 20mA
		12MB, 756	BF321-0UG-014B	12/14V	20	58	
		24MB,	BF321-0UG-024B	24V	20	58	
		313,757,1819,1829	BF321-0UG-028B	28V	20	58	
		48MB	BF321-0UG-048B	48V	12	35	
		60MB,1835	BF321-0UG-060B	60V	12	35	
		120MB, NE51H	BF321-0UG-120A	120VAC	10	29	
	BF321-0UG-130B	130V	8	23			
570nm Lime Green InGaAlP  BF304 	T3-1/4 (9mm) Miniature Bayonet LED Cluster	6MB, 44, 47, 755	BF304-0UG-006B	5/6V	80	232	120° Center Contact Polarity B = Bipolar AC/DC A = AC only Replace BF304 With B304 for Narrow Beam (12-15°) 4K mcd @ 20mA
		12MB, 756	BF304-0UG-014B	12/14V	40	232	
		24MB,	BF304-0UG-024B	24V	20	232	
		313,757,1819,1829	BF304-0UG-028B	28V	20	232	
		48MB	BF304-0UG-048B	48V	12	140	
		60MB,1835	BF304-0UG-060B	60V	12	140	
		120MB, NE51H	BF304-0UG-120A	120VAC	10	116	
	BF304-0UG-130B	130V	8	92			
570nm Lime Green InGaAlP  BF3126/ BF3127 	T3-1/4 (9mm) Miniature Bayonet LED Cluster	6MB, 44, 47, 755	BF3126-0UG-006B	5/6V	120	216	120° Center Contact Polarity B = Bipolar AC/DC A = AC only Replace BF3126/3127 With B3126/3127 for Medium Beam (50°) 1.2K mcd @ 20mA
		12MB, 756	BF3126-0UG-014B	12/14V	40	216	
		24MB,	BF3127-0UG-024B	24V	20	252	
		313,757,1819,1829	BF3127-0UG-028B	28V	20	252	
		48MB	BF3127-0UG-048B	48V	12	154	
		60MB,1835	BF3127-0UG-060B	60V	12	154	
		120MB, NE51H	BF3127-0UG-120A	120VAC	10	126	
	BF3127-0UG-130B	130V	8	100			
525nm Aqua Green SiC/GaN  BF321 	T3-1/4 (9mm) Miniature Bayonet	6MB, 44, 47, 755	BF321-0AG-006B	5/6V	15	400	120° Center Contact Polarity B = Bipolar AC/DC A = AC only Replace BF321 With B321 for Narrow Beam (15°) 7K mcd/250 Ft.Cd @ 15mA
		12MB, 756	BF321-0AG-014B	12/14V	15	400	
		24MB,	BF321-0AG-024B	24V	15	400	
		313,757,1819,1829	BF321-0AG-028B	28V	15	400	
		48MB	BF321-0AG-048B	48V	12	320	
		60MB,1835	BF321-0AG-060B	60V	12	320	
		120MB, NE51H	BF321-0AG-120A	120VAC	10	275	
	BF321-0AG-130B	130V	8	230			
525nm Aqua Green SiC/GaN  BF304 	T3-1/4 (9mm) Miniature Bayonet LED Cluster	6MB, 44, 47, 755	BF304-0AG-006B	5/6V	60	1600	120° Center Contact Polarity B = Bipolar AC/DC A = AC only Replace BF304 With B304 for Narrow Beam (15°) 28K mcd/1000 Ft.Cd @ 15mA
		12MB, 756	BF304-0AG-014B	12/14V	30	1600	
		24MB,	BF304-0AG-024B	24V	15	1600	
		313,757,1819,1829	BF304-0AG-028B	28V	15	1600	
		48MB	BF304-0AG-048B	48V	12	1280	
		60MB,1835	BF304-0AG-060B	60V	12	1280	
		120MB, NE51H	BF304-0AG-120A	120VAC	10	1100	
	BF304-0AG-130B	130V	8	920			
525nm Aqua Green SiC/GaN  BF3126/ BF3127 	T3-1/4 (9mm) Miniature Bayonet LED Cluster	6MB, 44, 47, 755	BF3126-0AG-006B	5/6V	90	1200	120° Center Contact Polarity B = Bipolar AC/DC A = AC only Replace BF3126/3127 With B3126/3127 for Narrow Beam (15°) 30K mcd/800 Ft.Cd @ 15mA
		12MB, 756	BF3126-0AG-014B	12/14V	30	1200	
		24MB,	BF3126-0AG-024B	24V	15	1200	
		313,757,1819,1829	BF3127-0AG-028B	28V	15	1400	
		48MB	BF3127-0AG-048B	48V	12	1190	
		60MB,1835	BF3127-0AG-060B	60V	12	1190	
		120MB, NE51H	BF3127-0AG-120A	120VAC	10	1050	
	BF3127-0AG-130B	130V	8	910			

All dimensions in inches. For millimeters multiply by 25.4

Log # 122K Rev 10-2000

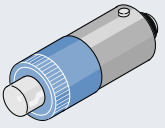
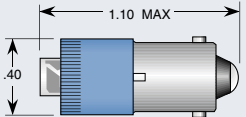
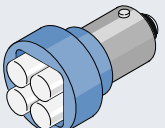
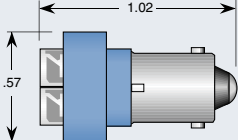
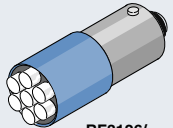
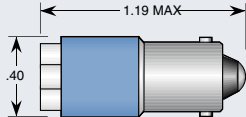

T3-1/4 (9mm) Miniature Based LED Lamps

Miniature Packages		Replaces Incandescent	Part Number	Electrical-Optical Characteristics (Ta = 25°C)			Angle of Illumination	Special Features
				Voltage V typ	Current mA typ	Intensity mcd		
470nm Super Blue SiC/GaN  BF321	T3-1/4 (9mm) Miniature Bayonet 	6MB, 44, 47, 755	BF321-0PB-006B	5/6V	15	116	120°	Center Contact Polarity B = Bipolar AC/DC A = AC only Replace BF321 With B321 for Std. Beam (15°)
		12MB, 756	BF321-0PB-014B	12/14V	15	116		
		24MB,	BF321-0PB-024B	24V	15	116		
		313,757,1819,1829	BF321-0PB-028B	28V	15	116		
		48MB	BF321-0PB-048B	48V	12	84		
		60MB,1835	BF321-0PB-060B	60V	12	84		
		120MB, NE51H	BF321-0PB-120A	120VAC	10	74		
	BF321-0PB-130B	130V	8	53				
470nm Super Blue SiC/GaN  BF304	T3-1/4 (9mm) Miniature Bayonet LED Cluster 	6MB, 44, 47, 755	BF304-0PB-006B	5/6V	60	464	120°	Center Contact Polarity B = Bipolar AC/DC A = AC only Replace BF304 With B304 for Std. Beam (15°)
		12MB, 756	BF304-0PB-014B	12/14V	30	464		
		24MB,	BF304-0PB-024B	24V	15	464		
		313,757,1819,1829	BF304-0PB-028B	28V	15	464		
		48MB	BF304-0PB-048B	48V	12	336		
		60MB,1835	BF304-0PB-060B	60V	12	336		
		120MB, NE51H	BF304-0PB-120A	120VAC	10	296		
	BF304-0PB-130B	130V	8	212				
470nm Super Blue SiC/GaN  BF3126/ BF3127	T3-1/4 (9mm) Miniature Bayonet LED Cluster 	6MB, 44, 47, 755	BF3126-0PB-006B	5/6V	90	360	120°	Center Contact Polarity B = Bipolar AC/DC A = AC only Replace BF3126/3127 With B3126/3127 for Std. Beam (15°)
		12MB, 756	BF3126-0PB-014B	12/14V	30	360		
		24MB,	BF3127-0PB-024B	24V	15	420		
		313,757,1819,1829	BF3127-0PB-028B	28V	15	420		
		48MB	BF3127-0PB-048B	48V	12	336		
		60MB,1835	BF3127-0PB-060B	60V	12	336		
		120MB, NE51H	BF3127-0PB-120A	120VAC	10	315		
	BF3127-0PB-130B	130V	8	252				

Options

All dimensions in inches. For millimeters multiply by 25.4

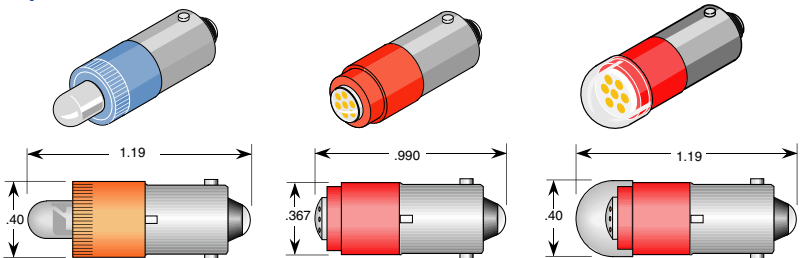

Series: B321

PN Example: B321-0UO-006B

Series: BM326

PN Example: BM326-0UR-006B

Series: B3206

PN Example: B3206-0UR-120A

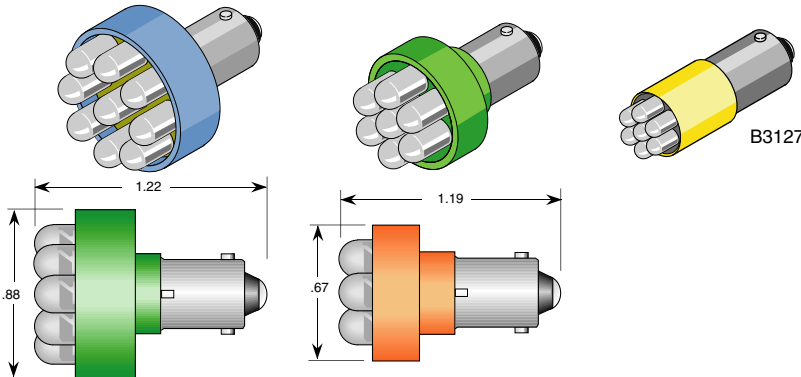

Series: BN309

PN Example: BN309-0AG-024B

Series: BN306/BN307

PN Example: BN306-0UO-006B

B3127

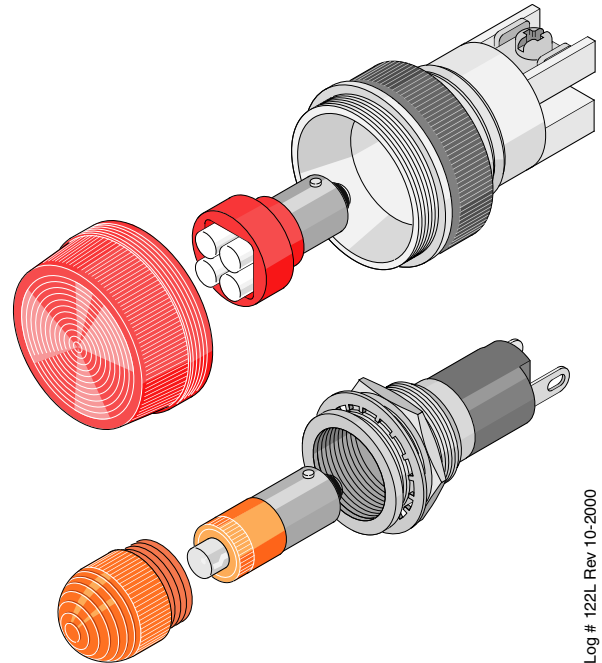

Log # 122L Rev 10-2000