

Metallized Paper (MP) RFI-Capacitors Class X1 PCM 10 mm to 27.5 mm

Special Features

- Particularly high reliability against active and passive flammability
- Excellent self-healing as well as high voltage strength
- High degree of interference suppression due to good attenuation and low ESR
- For temperatures up to +110° C
- According to RoHS 2002/95/EC

Typical Applications

Class X1 RFI applications to meet EMC regulations

- Capacitors connected to the mains between phase and neutral or phase and phase conductors
- Installation category III in accordance with IEC 60664, pulse peak voltage ≤ 4 kV

Construction

Dielectric:

Paper, epoxy resin impregnated

Capacitor electrodes:

Vacuum-deposited

Internal construction:

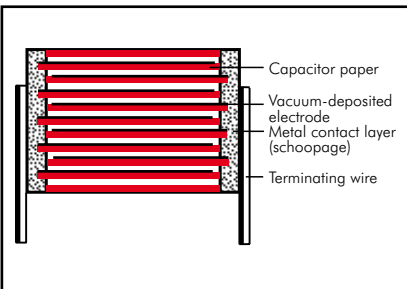

Encapsulation:

Self-extinguishing epoxy resin, UL 94 V-0, metal foil

Terminations:

Tinned wire.

Marking:

Marking: Black on Silver.

Electrical Data

Capacitance range:

1000 pF to 0.22 μ F (E12-values on request)

Rated voltages:

300 VAC, 440 VAC, 500 VAC

Continuous DC voltage* (general guide):

≤ 730 V for 300 VAC

≤ 850 V for 440 VAC and 500 VAC

Capacitance tolerances: $\pm 20\%$

Operating temperature range:

-40° C to +110° C

Climatic test category:

40/110/56/C in accordance with IEC

Insulation resistance at +20° C:

$\geq 12 \times 10^3$ M Ω

Measuring voltage:

100 V/1 min. for 300 VAC and 440 VAC

500 V/1 min. for 500 VAC

Dissipation factors:

$\tan \delta \leq 13 \times 10^{-3}$ at 1 kHz and +20° C

Approvals:

| Country | Authority | Specification | Symbol | Approval-No. |
|---------|-----------|----------------------------------|--------|---|
| Germany | VDE | DIN EN 132 400 IEC 60384-14/2 | | 101355 (440/500 VAC) 89748 (300 VAC) |
| USA | UL | UL 1283 | | E 100438 (300 VAC) |
| Canada | CSA | C 22.2 No. 8 | | LR 93312-1 (300 VAC) |

Test specifications:

In accordance with DIN EN 60384-14

Maximum pulse rise time:

| Capacitance pF/ μ F | Pulse rise time V/ μ sec max. operation |
|----------------------------|--|
| 1000 ... 1500 | 1100 |
| 2200 ... 4700 | 500 |
| 6800 ... 0.033 | 200 |
| 0.047 ... 0.22 | 100 |

for pulses equal to a voltage amplitude with $\sqrt{2} \times 300$ VAC = 425 V, with $\sqrt{2} \times 440$ VAC = 623 V, with $\sqrt{2} \times 500$ VAC = 707 V according to IEC 60384-14

Test voltage: 3000 VDC, 2 sec.

Reliability:

Operational life > 300 000 hours

Failure rate < 1 fit (0.5 x U_r and 40° C)

Mounting Recommendation

To minimize or avoid shock and/or vibration stresses to terminating wires and solder connections we recommend to fix voluminous resin-potted MP capacitors as from e.g. PCM 22.5 mm in an appropriate way since for constructional reasons they do not sit tight on the board.

* If safety-approved EMI suppression capacitors are operated with a DC voltage being above the specified AC voltage rating the given approvals are no longer valid (DIN EN 60384-14).

Furthermore the permissible pulse rise time du/dt ($F_{max.}$) will be subject to a reduction according to

$$F_{max.} = F_r \times \sqrt{2} \times UAC / UDC$$

if the DC operating voltage UDC is higher than $\sqrt{2} \times UAC$

Packing

Available taped and reeled up to and including PCM 22.5 mm.

Detailed taping information and graphs at the end of the catalogue.

For further details and graphs please refer to Technical Information.

Continuation

General Data

| Capacitance | 300 VAC* | | | | 440 VAC* | | | | 500 VAC* | | | |
|-------------|----------|-----|------|-------|----------|----|----|-------|----------|----|----|-------|
| | W | H | L | PCM** | W | H | L | PCM** | W | H | L | PCM** |
| 1000 pF | 4 | 8.5 | 13.5 | 10 | | | | | | | | |
| 1500 " | 4 | 8.5 | 13.5 | 10 | | | | | | | | |
| 2200 " | 4 | 8.5 | 13.5 | 10 | | | | | | | | |
| 3300 " | 4 | 8.5 | 13.5 | 10 | | | | | | | | |
| 4700 " | 5 | 10 | 13.5 | 10 | | | | | | | | |
| 6800 " | 5 | 13 | 19 | 15 | 5 | 13 | 19 | 15 | 5 | 13 | 19 | 15 |
| 0.01 μF | 5 | 13 | 19 | 15 | 5 | 13 | 19 | 15 | 5 | 13 | 19 | 15 |
| 0.015 " | 6 | 14 | 19 | 15 | 6 | 14 | 19 | 15 | 6 | 14 | 19 | 15 |
| 0.022 " | 7 | 15 | 19 | 15 | 7 | 15 | 19 | 15 | 7 | 15 | 19 | 15 |
| 0.033 " | 8 | 17 | 19 | 15 | 10 | 18 | 19 | 15 | 10 | 18 | 19 | 15 |
| 0.047 " | 10 | 18 | 19 | 15 | | | | | | | | |
| 0.068 " | 8 | 20 | 28 | 22.5 | | | | | | | | |
| 0.1 μF | 10 | 22 | 28 | 22.5 | | | | | | | | |
| 0.15 " | 12 | 24 | 28 | 22.5 | | | | | | | | |
| 0.22 " | 13 | 25 | 33 | 27.5 | | | | | | | | |

* f = 50/60 Hz

** PCM = Printed circuit module = lead spacing

Upon request with long leads 35-2 mm max.

Dims. in mm.

Taped version see page 121.

Rights reserved to amend design data without prior notification.

d = 0.6 ø if PCM10
d = 0.8 ø if PCM ≥ 15

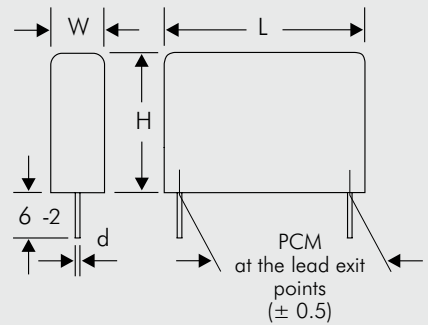

Typical Graphs of the Capacitor Paper Dielectric

valid for:

MP 3-X2

MP 3-X1

MP 3-Y2

MP 3R-Y2

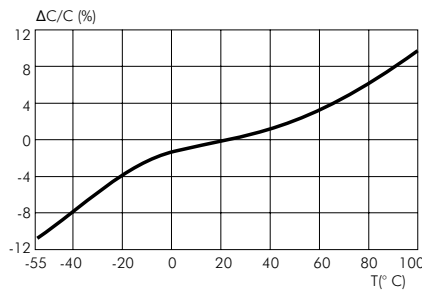

Capacitance change versus temperature (f=1 kHz) (general guide)

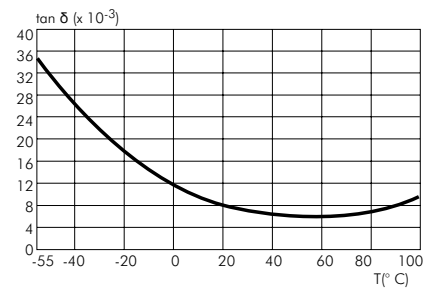

Dissipation factor change versus temperature (f=1 kHz) (general guide)

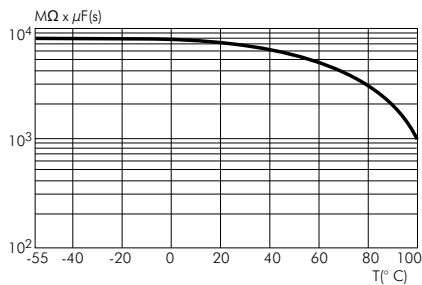

Insulation resistance change versus temperature (general guide)

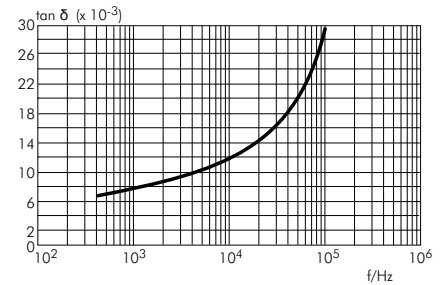

Dissipation factor change versus frequency (general guide).

Recommendation for Processing and Application of Through-Hole Capacitors

Soldering Process

A preheating of through-hole WIMA capacitors is allowed for temperatures $T_{\max} < 100^{\circ}\text{C}$. In practice a preheating duration of $t < 5$ min. has been proven to be best.

Single wave soldering

Soldering bath temperature: $T < 260^{\circ}\text{C}$
Immersion time: $t < 5$ sec

Double wave soldering

Soldering bath temperature: $T < 260^{\circ}\text{C}$
Immersion time: $2 \times t < 3$ sec

Due to different soldering processes and heat requirements the graphs are to be regarded as a recommendation only.



WIMA Quality and Environmental Philosophy

ISO 9001:2000 Certification

ISO 9001:2000 is an international basic standard of quality assurance systems for all branches of industry. The approval according to ISO 9001:2000 of our factories by the VDE inspectorate certifies that organisation, equipment and monitoring of quality assurance in our factories correspond to internationally recognized standards.

WIMA WPCS

The WIMA Process Control System (WPCS) is a quality surveillance and optimization system developed by WIMA. WPCS is a major part of the quality-oriented WIMA production. Points of application of WPCS during production process:

- incoming material inspection
- metallization
- film inspection
- schoopage
- pre-healing
- lead attachment
- cast resin preparation/encapsulation
- 100% final inspection
- AQL check

WIMA Environmental Policy

All WIMA capacitors, irrespective of whether through-hole devices or SMD, are made of environmentally friendly materials. Neither during manufacture nor in the product itself any toxic substances are used, e.g.

- Lead
- PCB
- CFC
- Hydrocarbon chloride
- Chromium 6+
- PBB/PBDE
- Arsenic
- Cadmium
- Mercury
- etc.

We merely use pure, recyclable materials for packing our components, such as:

- carton
- cardboard
- adhesive tape made of paper
- polystyrene

We almost completely refrain from using packing materials such as:

- foamed polystyrene (Styropor®)
- adhesive tapes made of plastic
- metal clips

RoHS Compliance

According to the RoHS Directive 2002/95/EC certain hazardous substances like e.g. lead, cadmium, mercury must not be used any longer in electronic equipment as of July 1st, 2006. For the sake of the environment WIMA has refrained from using such substances since years already.



WIMA Kondensatoren sind bleifrei konform RoHS 2002/95/EG

WIMA capacitors are lead free in accordance with RoHS 2002/95/EC

Tape for lead-free WIMA capacitors

DIN EN ISO 14001:2005

WIMA's environmental management has been established in accordance with the guidelines of DIN EN ISO 14001:2005. The certification has been granted in June 2006.

Typical Dimensions for Taping Configuration

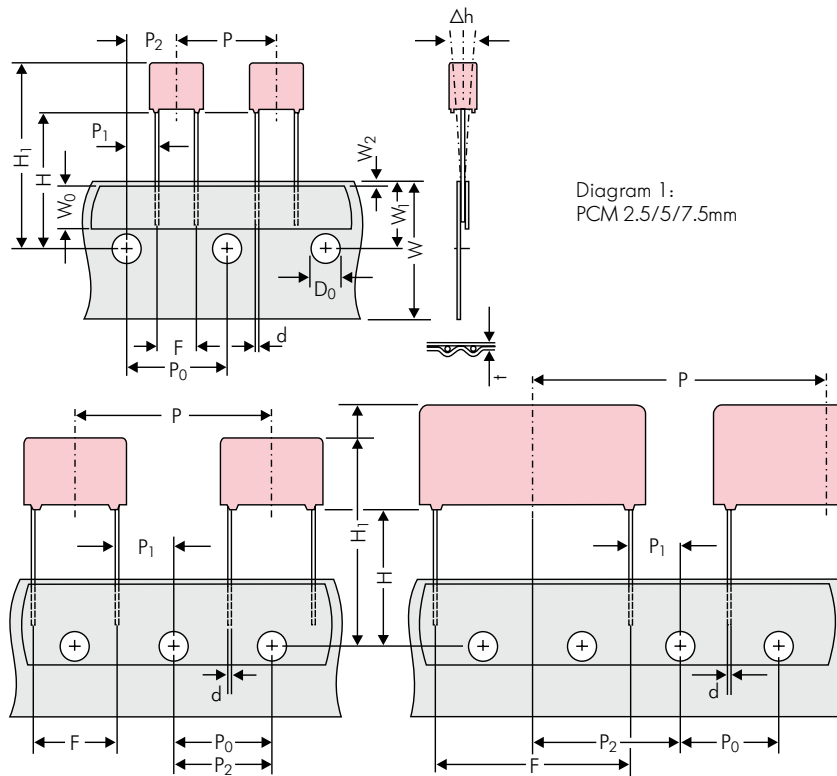

Diagram 1:
PCM 2.5/5/7.5mm

Diagram 2: PCM 10/15 mm

Diagram 3: PCM 22.5 and 27.5*mm

*PCM 27.5 taping possible with two feed holes between components

| Designation | Symbol | Dimensions for Radial Taping | | | | | | |
|--|----------------|--|--|---|---|---|---|---|
| | | PCM 2.5 taping | PCM 5 taping | PCM 7.5 taping | PCM 10 taping* | PCM 15 taping* | PCM 22.5 taping | PCM 27.5 taping |
| Carrier tape width | W | 18.0 ±0.5 | 18.0 ±0.5 | 18.0 ±0.5 | 18.0 ±0.5 | 18.0 ±0.5 | 18.0 ±0.5 | 18.0 ±0.5 |
| Hold-down tape width | W ₀ | 6.0 for hot-sealing adhesive tape | 6.0 for hot-sealing adhesive tape | 12.0 for hot-sealing adhesive tape | 12.0 for hot-sealing adhesive tape | 12.0 for hot-sealing adhesive tape | 12.0 for hot-sealing adhesive tape | 12.0 for hot-sealing adhesive tape |
| Hole position | W ₁ | 9.0 ±0.5 | 9.0 ±0.5 | 9.0 ±0.5 | 9.0 ±0.5 | 9.0 ±0.5 | 9.0 ±0.5 | 9.0 ±0.5 |
| Hold-down tape position | W ₂ | 0.5 to 3.0 max. | 0.5 to 3.0 max. | 0.5 to 3.0 max. | 0.5 to 3.0 max. | 0.5 to 3.0 max. | 0.5 to 3.0 max. | 0.5 to 3.0 max. |
| Feed hole diameter | D ₀ | 4.0 ±0.2 | 4.0 ±0.2 | 4.0 ±0.2 | 4.0 ±0.2 | 4.0 ±0.2 | 4.0 ±0.2 | 4.0 ±0.2 |
| Pitch of component | P | 12.7 ±1.0 | 12.7 ±1.0 | 12.7 ±1.0 | 25.4 ±1.0 | 25.4 ±1.0 | 38.1 ±1.5 | 38.1 ±1.5 or 50.8 ±1.5 |
| Feed hole pitch | P ₀ | 12.7 ±0.3 cumulative pitch error max. 1.0 mm/20 pitch | 12.7 ±0.3 cumulative pitch error max. 1.0 mm/20 pitch | 12.7 ±0.3 cumulative pitch error max. 1.0 mm/20 pitch | 12.7 ±0.3 cumulative pitch error max. 1.0 mm/20 pitch | 12.7 ±0.3 cumulative pitch error max. 1.0 mm/20 pitch | 12.7 ±0.3 cumulative pitch error max. 1.0 mm/20 pitch | 12.7 ±0.3 cumulative pitch error max. 1.0 mm/20 pitch |
| Feed hole centre to lead | P ₁ | 5.1 ±0.5 | 3.85 ±0.7 | 2.6 ±0.7 | 7.7 ±0.7 | 5.2 ±0.7 | 7.8 ±0.7 | 5.3 ±0.7 |
| Hole centre to component centre | P ₂ | 6.35 ±1.3 | 6.35 ±1.3 | 6.35 ±1.3 | 12.7 ±1.3 | 12.7 ±1.3 | 19.05 ±1.3 | 19.05 ±1.3 |
| Feed hole centre to bottom edge of the component | H _▲ | 16.5 ±0.3 18.5 ±0.5 | 16.5 ±0.3 18.5 ±0.5 | 16.5 ±0.5 18.5 ±0.5 | 16.5 ±0.5 18.5 ±0.5 | 16.5 ±0.5 18.5 ±0.5 | 16.5 ±0.5 18.5 ±0.5 | 16.5 ±0.5 18.5 ±0.5 |
| Feed hole centre to top edge of the component | H ₁ | H+H _{component} < H ₁ 32.25 max. | H+H _{component} < H ₁ 32.25 max. | H+H _{component} < H ₁ 24.5 to 31.5 | H+H _{component} < H ₁ 25.0 to 31.5 | H+H _{component} < H ₁ 26.0 to 37.0 | H+H _{component} < H ₁ 30.0 to 43.0 | H+H _{component} < H ₁ 35.0 to 45.0 |
| Lead spacing at upper edge of carrier tape | F | 2.5 ±0.5 | 5.0 ^{+0.8} _{-0.2} | 7.5 ±0.8 | 10.0 ±0.8 | 15 ±0.8 | 22.5 ±0.8 | 27.5 ±0.8 |
| Lead diameter | d | 0.4 ±0.05 | 0.5 ±0.05 | 0.5 ±0.05 or 0.6 ^{+0.06} _{-0.05} | 0.5 ±0.05 or 0.6 ^{+0.06} _{-0.05} | 0.8 ^{+0.08} _{-0.05} | 0.8 ^{+0.08} _{-0.05} | 0.8 ^{+0.08} _{-0.05} |
| Component alignment | Δh | ± 2.0 max. | ± 2.0 max. | ± 3.0 max. | ± 3.0 max. | ± 3.0 max. | ± 3.0 max. | ± 3.0 max. |
| Total tape thickness | t | 0.7 ±0.2 | 0.7 ±0.2 | 0.7 ±0.2 | 0.7 ±0.2 | 0.7 ±0.2 | 0.7 ±0.2 | 0.7 ±0.2 |
| Package (see also page 122) | ▲ | ROLL/AMMO | | | AMMO | | | |
| | | REEL ø 360 max. ø 30 ±1 | B 52 ±2 58 ±2 } depending on comp. dimensions | | REEL ø 360 max. ø 30 ±1 | 52 ±2 58 ±2 or 66 ±2 | REEL ø 500 max. ø 25 ±1 | 54 ±2 60 ±2 68 ±2 } depending on PCM and component dimensions |
| Unit | | see details page 124. | | | | | | |

▲ Please give „H“ dimensions and desired packaging type when ordering.

• Diameter of leads see General Data.

* PCM 10 and PCM 15 can be crimped to PCM 7.5.

Position of components according to PCM 7.5 (sketch 11). P₀ = 12.7 or 15.0 is possible

Dims in mm.

Please clarify customer-specific deviations with the manufacturer.