



Metallized Polypropylene Film AC Power Capacitor

series

Specifications

Item	Performance Characteristics
Maximum permissible temperature	+85°C (Z)
Minimum ambient temperature	-25°C (B)
Rated Voltage Range	200 ~ 460VAC
Rated Capacitance Range	1.0 ~ 30μF
Capacitance Tolerance	+10 ~ -5%
Dielectric Loss Tangent	0.12% or less (at 20°C, 50 / 60Hz 200VAC)
Withstand Voltage	Between Terminals : Rated Voltage (VAC) × 175% 10secs. Between Terminals connected together and case : 2000VAC 60secs.
Insulation Resistance	Between Terminals connected together and case : 1000 MΩ or more (at 500VDC)
Encapsulation	Flame-retardant epoxy cased, Resin filled
Current duration class	40D (40,000h)
Safety Mechanism	Non-included



Drawing

Please refer to page 249.

Dimensions

Unit : mm

(μF) Cap.	V (Code) Size Code	200VAC (2D)				250VAC (2E)				400VAC (2G)				460VAC (W7)			
		A	B	C	Fig.	A	B	C	Fig.	A	B	C	Fig.	A	B	C	Fig.
1.0	105	-	-	-		-	-	-		37.0	11.5	25.0		37.0	11.5	25.0	
1.5	155	-	-	-		-	-	-		37.0	11.5	25.0		37.0	11.5	27.0	
2.0	205	37.0	11.5	25.0		37.0	11.5	25.0		37.0	13.5	27.0		37.0	15.5	29.0	
2.5	255	37.0	11.5	25.0		37.0	11.5	25.0		37.0	15.5	29.0		37.0	17.5	31.0	
3.0	305	37.0	11.5	25.0		37.0	11.5	25.0		37.0	15.5	29.0		37.0	19.5	33.0	① ④
3.5	355	37.0	11.5	25.0		37.0	11.5	25.0		37.0	17.5	31.0	① ④	37.0	21.5	35.0	⑦
4.0	405	37.0	11.5	25.0		37.0	11.5	25.0		37.0	19.5	33.0	⑦	37.0	21.5	35.0	
4.5	455	37.0	13.5	27.0		37.0	13.5	27.0		37.0	19.5	33.0		37.0	24.0	37.0	
5.0	505	37.0	13.5	27.0	① ④	37.0	13.5	27.0	① ④	37.0	21.5	35.0		37.0	24.0	37.0	
6.0	605	37.0	13.5	27.0	⑦	37.0	13.5	27.0	⑦	37.0	24.0	37.0		48.0	24.0	38.0	② ⑤
7.0	705	37.0	15.5	29.0		37.0	15.5	29.0		37.0	24.0	37.0		58.0	26.0	40.0	
8.0	805	37.0	15.5	29.0		37.0	15.5	29.0		48.0	24.0	38.0	② ⑤	58.0	26.0	40.0	
10.0	106	37.0	17.5	31.0		37.0	17.5	31.0		58.0	26.0	40.0		58.0	30.0	44.0	
12.0	126	37.0	21.5	35.0		37.0	21.5	35.0		58.0	26.0	40.0		58.0	30.0	44.0	③ ⑥
14.0	146	37.0	24.0	37.0		37.0	24.0	37.0		58.0	30.0	44.0		58.0	34.0	49.0	
15.0	156	37.0	24.0	37.0		37.0	24.0	37.0		58.0	30.0	44.0		58.0	34.0	49.0	
16.0	166	37.0	24.0	37.0		37.0	24.0	37.0		58.0	30.0	44.0		58.0	34.0	49.0	
18.0	186	48.0	21.5	35.0	② ⑤	48.0	21.5	35.0	② ⑤								
20.0	206	48.0	24.0	38.0		48.0	24.0	38.0									
22.0	226	58.0	26.0	40.0		58.0	26.0	40.0									
25.0	256	58.0	26.0	40.0	③ ⑥	58.0	26.0	40.0	③ ⑥								
30.0	306	58.0	26.0	40.0		58.0	26.0	40.0									

■ Drawing

- Tab terminal 2 (Terminal shape : □)

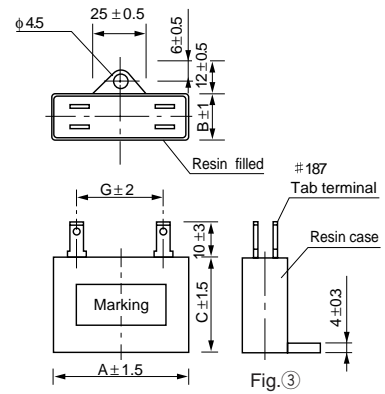
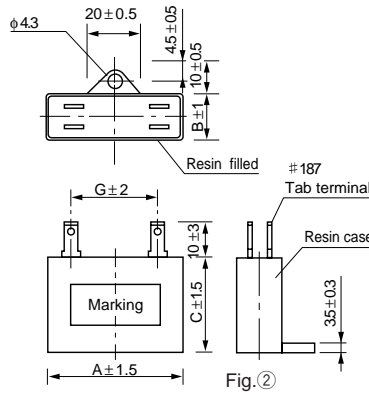
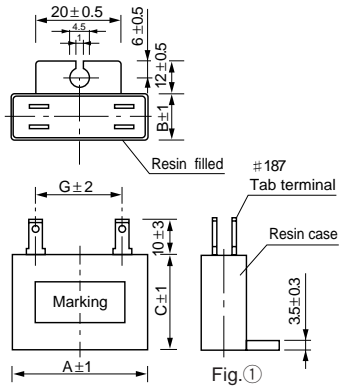

- Tab terminal 1 (Terminal shape : Z)

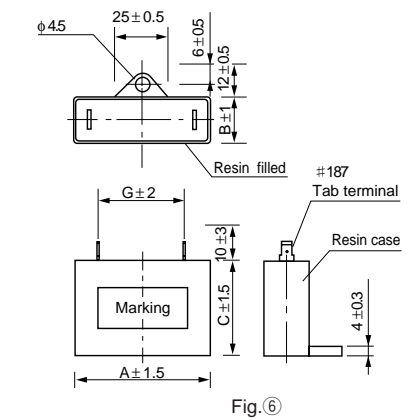
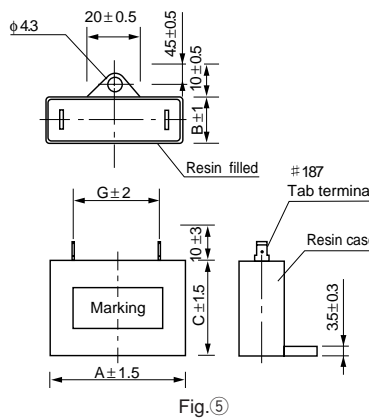
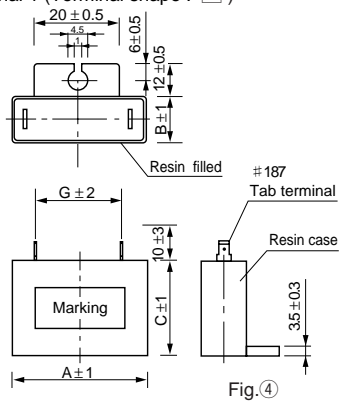

- Pin terminal (Terminal shape : W)

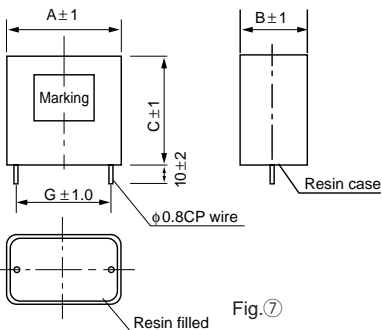

Remarks : 1) Tab terminal product has bracket as standard. It is also available without bracket.
 2) Dimension of case bottom is expressed by A and B.
 3) Dimension B of case top shall be ±1.0mm as shown below.

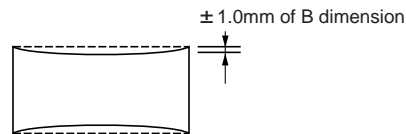

4) In case of pin terminal product, cased dimension A is only 37mm.

■ Dimensions

Case size (mm)			Case size code () for Pin terminal	Lead pitch G (mm)					
A	B	C		Terminal Shape □		Terminal Shape Z		Terminal Shape W	
				Terminal 2	Fig	Terminal 1	Fig	Pin terminal	Fig
37.0	11.5	25.0	01	27.0	①	30.0	④	34.2	⑦
37.0	13.5	27.0*	02 (09)**						
37.0	15.5	29.0	03 (27)**						
37.0	17.5	31.0	04 (11)***						
37.0	19.5	33.0	05						
37.0	21.5	35.0	06						
37.0	24.0	37.0	07						
48.0	21.5	35.0	13	37.0	②	40.0	⑤	—	—
48.0	24.0	38.0	14						
58.0	26.0	40.0	15	47.0	③	50.0	⑥	—	—
58.0	30.0	44.0	16						
58.0	34.0	49.0	31						

* In case of pin terminal product, dimension will be 37.0 × 13.5 × 28.0mm. (Code : 09)
 ** In case of pin terminal product, dimension will be 37.0 × 15.5 × 29.0mm. (Code : 27)
 *** In case of pin terminal product, dimension will be 37.0 × 17.5 × 31.0mm. (Code : 11)