

Part Number: AT2117ZG25Z1S-VFS

Green



**ATTENTION**  
OBSERVE PRECAUTIONS  
FOR HANDLING  
ELECTROSTATIC  
DISCHARGE  
SENSITIVE  
DEVICES

### Features

- Dimension: 2.15mmX 1.7mm X 0.8mm.
- Low thermal resistance.
- Ceramic package with silicone resin.
- Small package with high efficiency.
- Surface mount technology.
- ESD protection.
- Package : 2000pcs / reel.
- Moisture sensitivity level : level 2a.
- Soldering methods: IR reflow soldering.
- RoHS compliant.



### Application Note

Static electricity and surge damage the LEDs.

It is recommended to use a wrist band or anti-electrostatic glove when handling the LEDs.

All devices, equipment and machinery must be electrically grounded.

### Typical Applications

- Room lighting
- Architectural lighting
- Decorative/pathway lighting
- Front panel backlight

### Package Dimensions

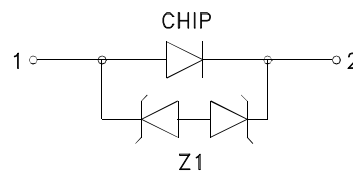
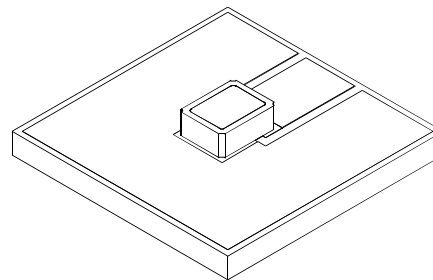
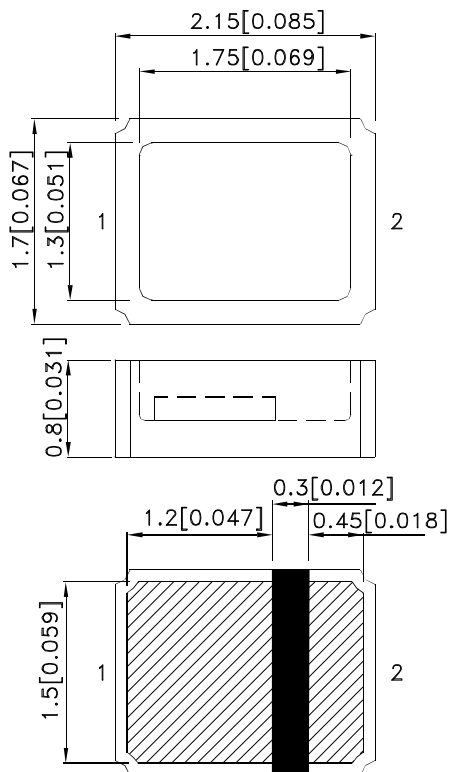

Notes:

1. All dimensions are in millimeters (inches).
2. Tolerance is  $\pm 0.25(0.01)$  unless otherwise noted.
3. The specifications, characteristics and technical data described in the datasheet are subject to change without prior notice.
4. The device has a single mounting surface. The device must be mounted according to the specifications.



## Absolute Maximum Ratings at $T_A=25^{\circ}\text{C}$

Parameter	Symbol	Value	Unit
Power Dissipation	$P_D$	600	mW
Junction Temperature [1]	$T_J$	110	$^{\circ}\text{C}$
Operating Temperature	$T_{op}$	-40 To +100	$^{\circ}\text{C}$
Storage Temperature	$T_{stg}$	-40 To +110	$^{\circ}\text{C}$
DC Forward Current [1]	$I_F$	150	mA
Reverse Voltage	$V_R$	5	V
Peak Forward Current [2]	$I_{FM}$	300	mA
Electrostatic Discharge Threshold (HBM)		8000	V
Thermal Resistance [1] (Junction/ambient)	$R_{th\ j-a}$	170	$^{\circ}\text{C}/\text{W}$
Thermal Resistance [1] (Junction/solder point)	$R_{th\ j-s}$	50	$^{\circ}\text{C}/\text{W}$

Notes:

- Results from mounting on metal core PCB, mounted on pc board-metal core PCB is recommend for lowest thermal resistance.
- 1/10 Duty Cycle, 0.1ms Pulse Width.

## Electrical / Optical Characteristics at $T_A=25^{\circ}\text{C}$

Parameter	Symbol	Value	Unit
Wavelength at peak emission $I_F=150\text{mA}$ [Typ.]	$\lambda_{\text{peak}}$	515	nm
Dominant Wavelength $I_F=150\text{mA}$ [Typ.]	$\lambda_{\text{dom}}$ [1]	525	nm
Spectral Line Half-width $I_F=150\text{mA}$ [Typ.]	$\Delta\lambda$	30	nm
Forward Voltage $I_F=150\text{mA}$ [Min.]	$V_F$ [2]	2.9	V
Forward Voltage $I_F=150\text{mA}$ [Typ.]		3.5	
Forward Voltage $I_F=150\text{mA}$ [Max.]		4.0	
Reverse Current ( $V_R = 5\text{V}$ ) [Max.]	$I_R$	10	$\mu\text{A}$
Temperature coefficient of $\lambda_{\text{peak}}$ $I_F=150\text{mA}$ , $-10^{\circ}\text{C} \leq T \leq 100^{\circ}\text{C}$ [Typ.]	$TC_{\lambda_{\text{peak}}}$	0.09	$\text{nm}/^{\circ}\text{C}$
Temperature coefficient of $\lambda_{\text{dom}}$ $I_F=150\text{mA}$ , $-10^{\circ}\text{C} \leq T \leq 100^{\circ}\text{C}$ [Typ.]	$TC_{\lambda_{\text{dom}}}$	0.03	$\text{nm}/^{\circ}\text{C}$
Temperature coefficient of $V_F$ $I_F=150\text{mA}$ , $-10^{\circ}\text{C} \leq T \leq 100^{\circ}\text{C}$ [Typ.]	$TC_V$	-2.7	$\text{mV}/^{\circ}\text{C}$

Notes:

- Wavelength is measured with a current pulse of 20ms at a tolerance of  $\pm 1\text{nm}$ .
- Forward voltage is measured with a current pulse of 10ms at a tolerance of  $\pm 0.1\text{V}$ .

## Selection Guide

Part No.	Dice	Lens Type	Luminous Intensity [2] lv(cd)@ 150mA		$\Phi_v$ (lm) [3] @ 150mA	Viewing Angle [1]
			Min.	Typ.	Typ.	2 $\theta$ 1/2
AT2117ZG25Z1S-VFS	Green (InGaN)	WATER CLEAR	2.8	4.2	22	120 °

## Brightness codes

Code.	luminous Intensity [2] lv(cd) @ 150mA		$\Phi_v$ (lm) [3] @ 150mA
	Min.	Max.	Typ.
ZA	2.8	3.8	17
ZB	3.3	4.5	20
ZC	3.8	5.5	25
ZD	4.7	6.5	30

Notes:

- $\theta$  1/2 is the angle from optical centerline where the luminous intensity is 1/2 of the optical peak value.
- Luminous intensity is measured by a current pulse of 10ms at a tolerance of  $\pm 15\%$ .
- The typical data of Luminous Flux can only reflect statistical figures, actual parameters of individual product could differ from the typical data.  
For the purpose of product enhancement, the typical data is subject to change without prior notice.  
Shipment may contain more than one of the light intensity groups.  
Orders for single light intensity group are generally not accepted.

## Forward Voltage Groups

Forward Voltage		Unit
Min.	Max.	
2.9	3.1	V
3.1	3.3	V
3.3	3.5	V
3.5	3.7	V
3.7	3.9	V
3.9	4.1	V

Notes:

- Forward voltage is measured with a current pulse of 10ms at a tolerance of  $\pm 0.1V$ .  
Shipment may contain more than one of the forward voltage groups.  
Orders for single forward voltage group are generally not accepted.

## AT2117ZG25Z1S-VFS

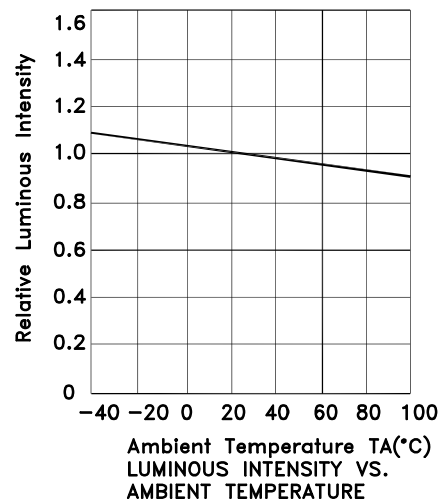
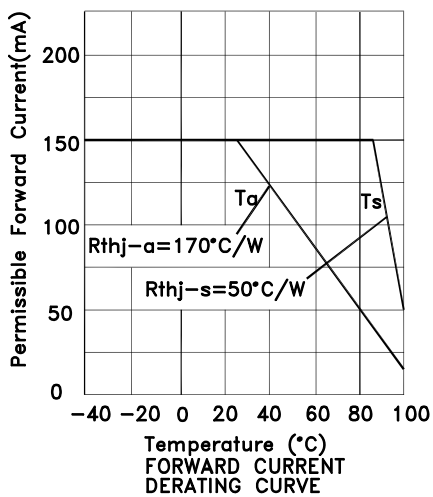
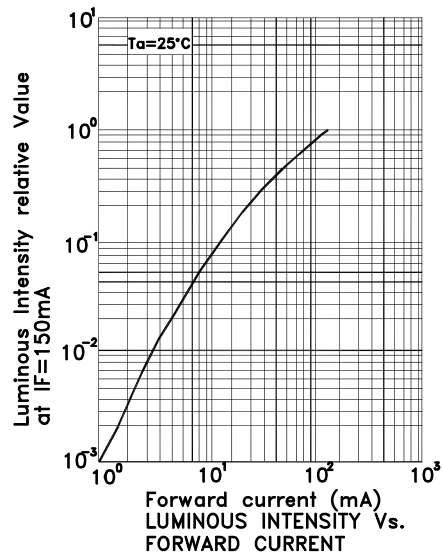
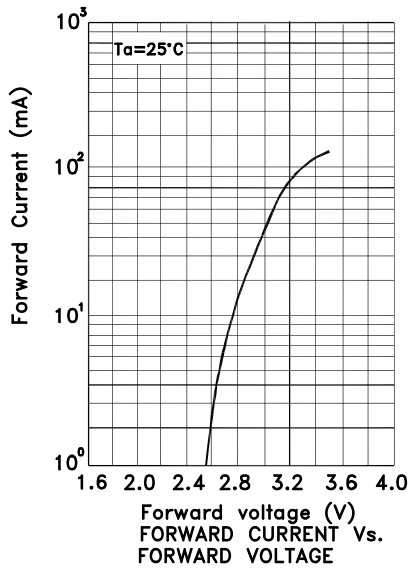
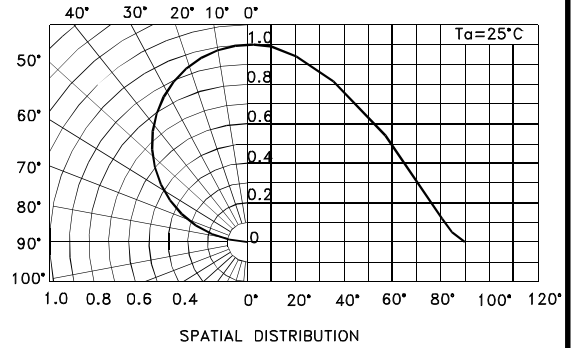
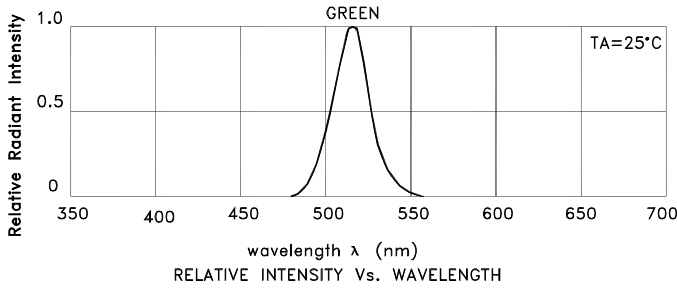

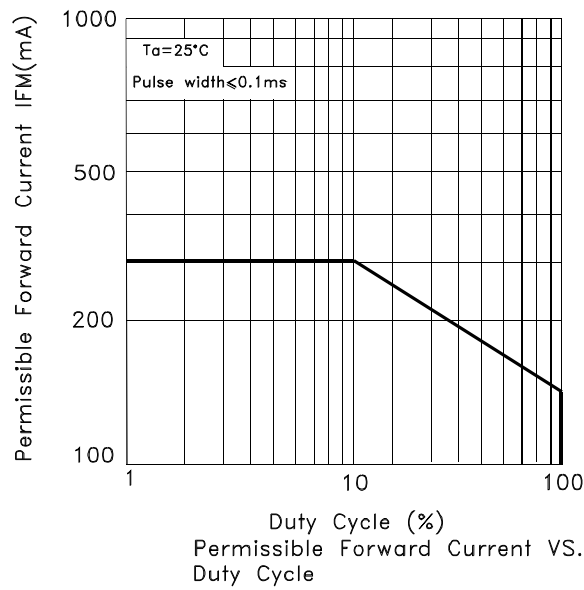
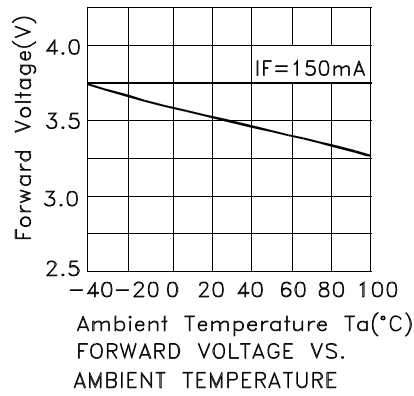
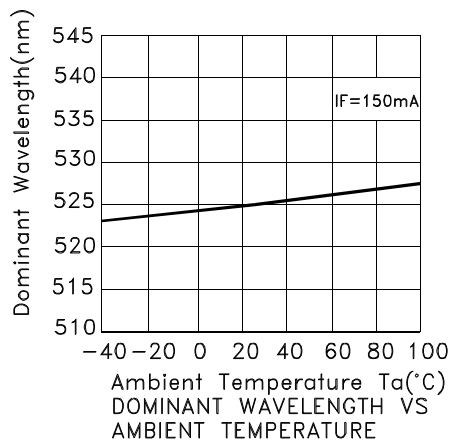

## AT2117ZG25Z1S-VFS

Reflow soldering is recommended and the soldering profile is shown below.  
Other soldering methods are not recommended as they might cause damage to the product.

Reflow Soldering Profile For Lead-free SMT Process.

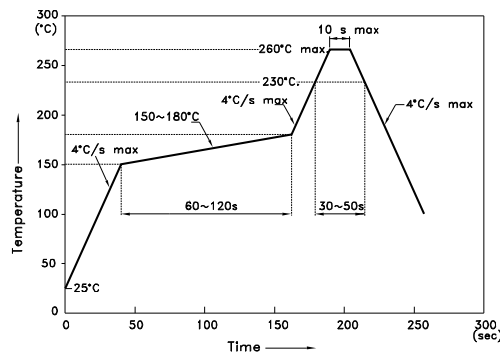

**NOTES:**

1. We recommend the reflow temperature 245°C(+/-5°C). The maximum soldering temperature should be limited to 260°C.
2. Don't cause stress to the epoxy resin while it is exposed to high temperature.
3. Number of reflow process shall be 2 times or less.

### Heat Generation:

1. Thermal design of the end product is of paramount importance. Please consider the heat generation of the LED when making the system design. The coefficient of temperature increase per input electric power is affected by the thermal resistance of the circuit board and density of LED placement on the board, as well as other components. It is necessary to avoid intense heat generation and operate within the maximum ratings given in this specification.

2. Please determine the operating current with consideration of the ambient temperature local to the LED and refer to the plot of Permissible Forward current vs. Ambient temperature on CHARACTERISTICS in this specification. Please also take measures to remove heat from the area near the LED to improve the operational characteristics on the LED.

3. The equation ① indicates correlation between  $T_j$  and  $T_a$ , and the equation ② indicates correlation between  $T_j$  and  $T_s$

$$T_j = T_a + R_{thj-a} * W \quad \text{.....} \quad \text{①}$$

$$T_j = T_s + R_{thj-s} * W \quad \text{.....} \quad \text{②}$$

$T_j$  = dice junction temperature: °C

$T_a$  = ambient temperature: °C

$T_s$  = solder point temperature: °C

$R_{thj-a}$  = heat resistance from dice junction temperature to ambient temperature : °C / W

$R_{thj-s}$  = heat resistance from dice junction temperature to  $T_s$  measuring point : °C / W

$W$  = inputting power ( $I_F \times V_F$ ) : W

**Recommended Soldering Pattern**  
(Units : mm; Tolerance:  $\pm 0.1$ )

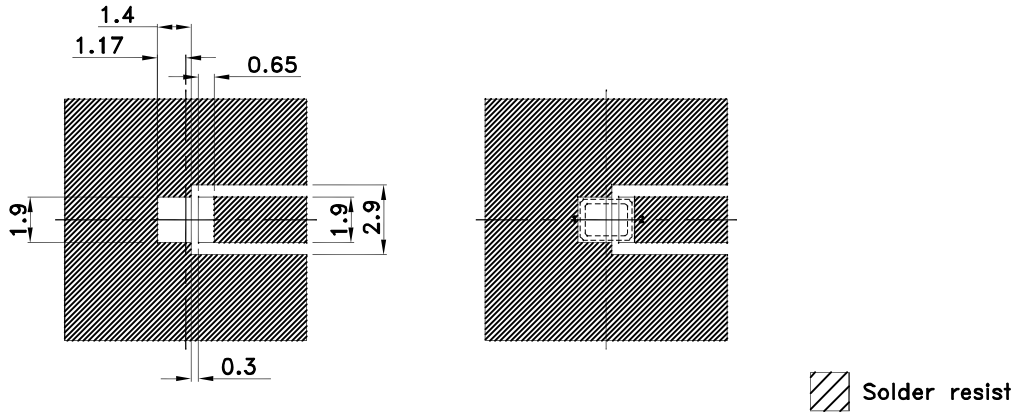

**Tape Specifications (Units : mm)**

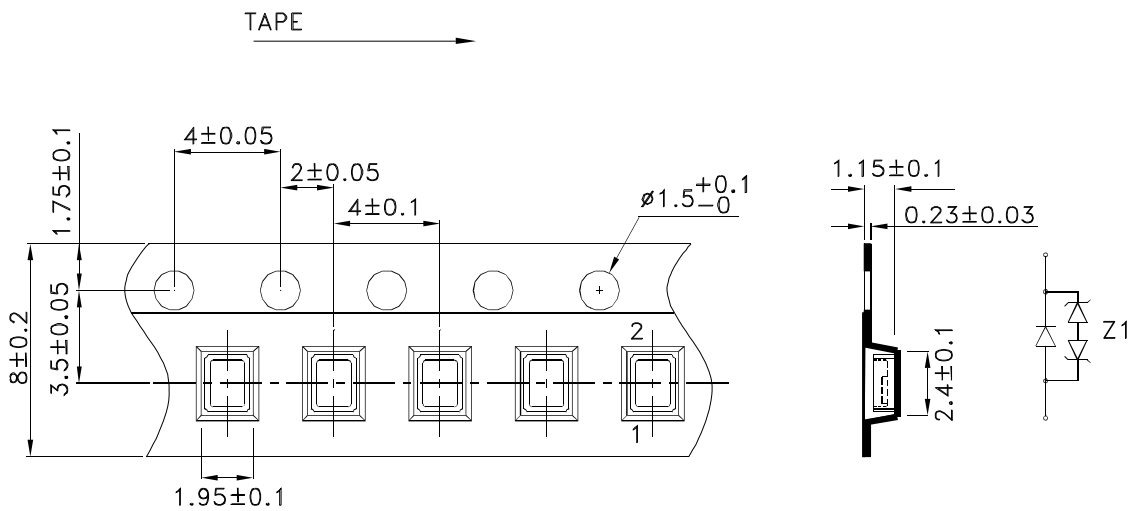

**Reel Dimension**

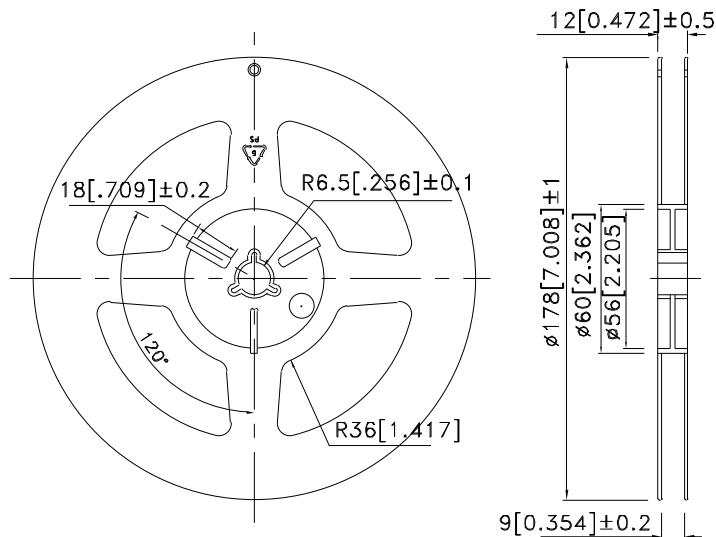

# Kingbright

## PACKING & LABEL SPECIFICATIONS

## AT2117ZG25Z1S-VFS

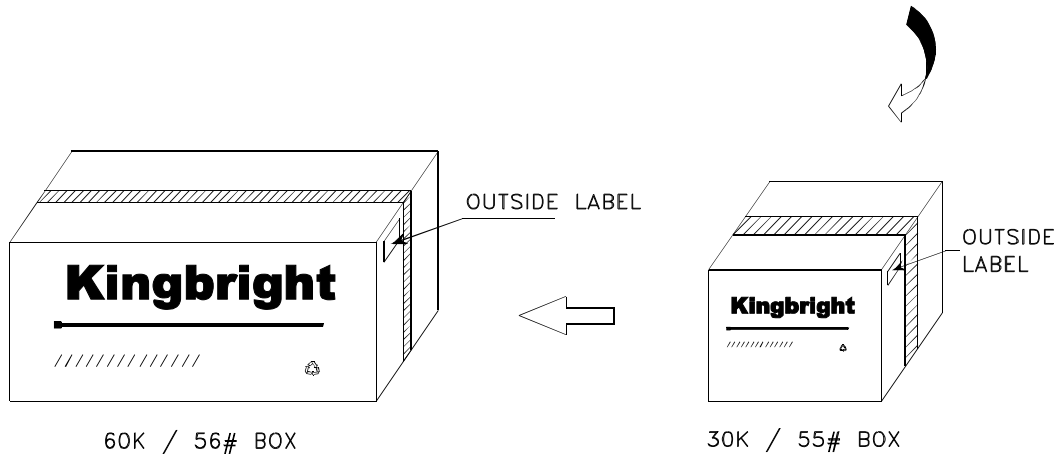
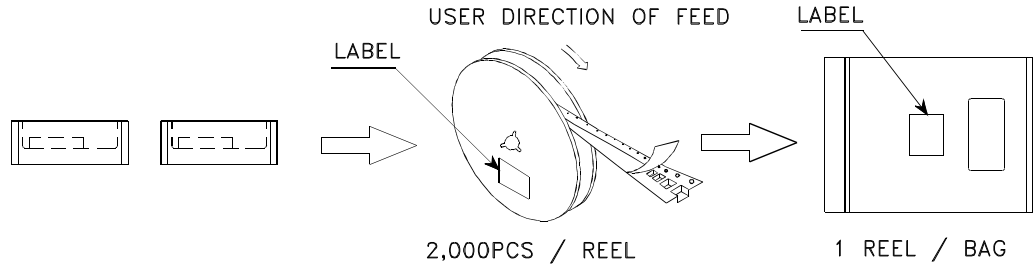

<b>Kingbright</b>	
P/NO: AT2117xxx	
QTY: 2,000 pcs	Q.C. <span style="border: 1px solid black; border-radius: 50%; padding: 2px;">Q C xx xx xxxx PASSED</span>
S/N: XXXX	
CODE: XXX	VF:xxV-xxV
LOT NO:	
 xxxxxxxxxxxxxxxxxxxxxxxxxxxx	
RoHS Compliant	



## Handling Precautions

Compare to epoxy encapsulant that is hard and brittle, silicone is softer and flexible. Although its characteristic significantly reduces thermal stress, it is more susceptible to damage by external mechanical force.

As a result, special handling precautions need to be observed during assembly using silicone encapsulated LED products. Failure to comply might leads to damage and premature failure of the LED.

1. Handle the component along the side surfaces by using forceps or appropriate tools.

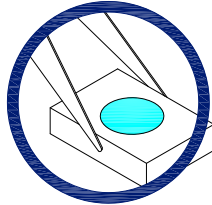

2. Do not directly touch or handle the silicone lens surface. It may damage the internal circuitry.

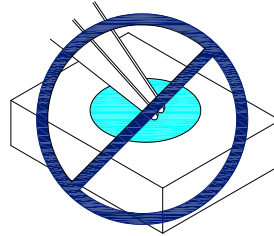
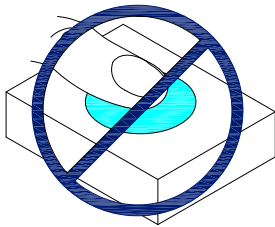

3. Do not stack together assembled PCBs containing exposed LEDs. Impact may scratch the silicone lens or damage the internal circuitry.

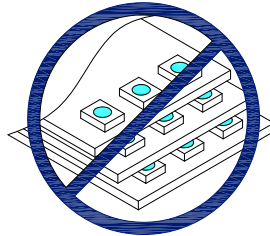

4. The outer diameter of the SMD pickup nozzle should not exceed the size of the LED to prevent air leaks. The inner diameter of the nozzle should be as large as possible.
5. A pliable material is suggested for the nozzle tip to avoid scratching or damaging the LED surface during pickup.
6. The dimensions of the component must be accurately programmed in the pick-and-place machine to insure precise pickup and avoid damage during production.

