

**SKiiP 82 AHB 15**

Absolute Maximum Ratings		Values	Units
Symbol	Conditions <sup>1)</sup>		
Bridge Rectifier			
V <sub>RRM</sub>		1500	V
I <sub>D</sub>	T <sub>heatsink</sub> = 80 °C	75	A
I <sub>FSM</sub> /I <sub>TSM</sub>	t <sub>p</sub> = 10 ms; sin. 180 °C, T <sub>j</sub> = 25 °C	1000	A
I <sub>pt</sub>	t <sub>p</sub> = 10 ms; sin. 180 °C, T <sub>j</sub> = 25 °C	5000	A <sup>2</sup> s
IGBT Chopper			
V <sub>CEs</sub>		1200	V
V <sub>GEs</sub>		± 20	V
I <sub>C</sub>	T <sub>heatsink</sub> = 25 / 80 °C	65 / 45	A
I <sub>CM</sub>	t <sub>p</sub> < 1 ms; T <sub>heatsink</sub> = 25 / 80 °C	130 / 90	A
Freewheeling Diode <sup>2)</sup>			
V <sub>RRM</sub>		1200	V
I <sub>F</sub>	T <sub>heatsink</sub> = 25 / 80 °C	38 / 26	A
I <sub>FM</sub>	t <sub>p</sub> < 1 ms; T <sub>heatsink</sub> = 25 / 80 °C	76 / 52	A
T <sub>j</sub>	Diode & IGBT	- 40 ... + 150	°C
T <sub>j</sub>	Thyristor	- 40 ... + 125	°C
T <sub>stg</sub>		- 40 ... + 125	°C
V <sub>isol</sub>	AC, 1 min.	2500	V

Characteristics		min.	typ.	max.	Units
Symbol	Conditions <sup>1)</sup>				
Diode - Rectifier					
V <sub>F</sub>	I <sub>F</sub> = 75 A T <sub>j</sub> = 125 °C	-	1,15	-	V
V <sub>TO</sub>	T <sub>j</sub> = 125 °C	-	0,8	-	V
r <sub>T</sub>	T <sub>j</sub> = 125 °C	-	4,5	-	mΩ
R <sub>thjh</sub>	per diode	-	-	1,0	K/W
Thyristor - Rectifier					
V <sub>T</sub>	I <sub>F</sub> = 120 A T <sub>j</sub> = 25 °C	-	-	1,8	V
V <sub>T</sub> (TO)	T <sub>j</sub> = 125 °C	-	-	1,1	V
r <sub>T</sub>	T <sub>j</sub> = 125 °C	-	-	5	mΩ
R <sub>thjh</sub>	per thyristor	-	-	0,9	K/W
I <sub>GD</sub>	T <sub>j</sub> = 125 °C	5	-	-	mA
V <sub>GT</sub>	T <sub>j</sub> = 25 °C	-	-	3	V
I <sub>GT</sub>		-	-	150	mA
I <sub>H</sub>	T <sub>j</sub> = 25 °C	-	250	-	mA
I <sub>L</sub>		-	600	-	mA
dv/dt <sub>CR</sub>	T <sub>j</sub> = 125 °C	500	-	-	V/μs
di/dt <sub>CR</sub>		-	-	125	A/μs
IGBT - Chopper					
V <sub>CEsat</sub>	I <sub>C</sub> = 50 A T <sub>j</sub> = 25 (125) °C	-	2,5(3,1)	3,0(3,7)	V
t <sub>d(on)</sub>	V <sub>CC</sub> = 600 V; V <sub>GE</sub> = ± 15 V	-	44	100	ns
t <sub>r</sub>		I <sub>C</sub> = 50 A; T <sub>j</sub> = 125 °C	-	56	100
t <sub>d(off)</sub>	R <sub>gon</sub> = R <sub>goff</sub> = 22 Ω	-	380	500	ns
t <sub>f</sub>		inductive load	-	70	100
E <sub>on</sub> + E <sub>off</sub>		-	13	-	mJ
C <sub>ies</sub>	V <sub>CE</sub> = 25 V; V <sub>GE</sub> = 0 V, 1 MHz	-	3,3	-	nF
R <sub>thjh</sub>	per IGBT	-	-	0,5	K/W

**MiniSKiiP 8**  
**SEMIKRON integrated intelligent Power**  
**SKiiP 82 AHB 15**  
**half controlled**  
**3-phase bridge rectifier + IGBT braking chopper**

Case M8a

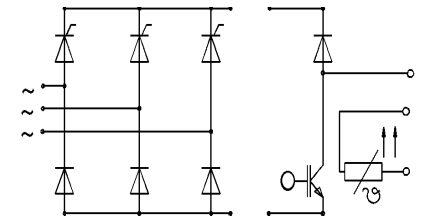
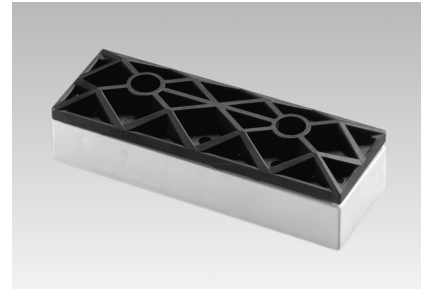

UL recognized file no. E63532

- specification of temperature sensor see part A
- common characteristics see page B 16 – 4

**Options**

- also available with uncontrolled rectifier (called 82 ANB 15)
- also available with powerful chopper, for characteristics please refer to SKiiP 82 AC 12
- also available with full controlled rectifier (called 82 ATB 15)

<sup>1)</sup> T<sub>heatsink</sub> = 25 °C, unless otherwise specified  
<sup>2)</sup> CAL = Controlled Axial Lifetime Technology (soft and fast recovery)

**MiniSKiiP 8**  
**SEMIKRON integrated**  
**intelligent Power**  
**SKiiP 82 AHB 15**  
**half controlled**  
**3-phase bridge rectifier +**  
**IGBT braking chopper**

Case M8a

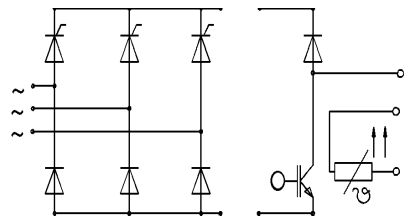
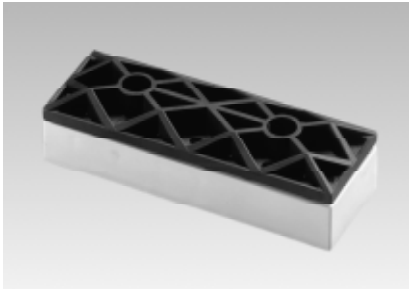

**SKiiP 82 AHB 15**

Characteristics		min.	typ.	max.	Units
<b>Symbol</b>	<b>Conditions</b> <sup>1)</sup>				
Diode <sup>2)</sup> - Freewheeling					
$V_F = V_{EC}$	$I_F = 25 \text{ A}$ $T_j = 25 (125) \text{ }^\circ\text{C}$	–	2,0(1,8)	2,5(2,3)	V
$V_{TO}$	$T_j = 125 \text{ }^\circ\text{C}$	–	1,0	1,2	V
$r_T$	$T_j = 125 \text{ }^\circ\text{C}$	–	32	44	m $\Omega$
$I_{RRM}$	$I_F = 25 \text{ A}; V_R = -600 \text{ V}$ $di_F/dt = -500 \text{ A}/\mu\text{s}$ $V_{GE} = 0 \text{ V}, T_j = 125 \text{ }^\circ\text{C}$ per diode	–	25	–	A
$Q_{rr}$		–	4,5	–	$\mu\text{C}$
$E_{off}$		–	1,0	–	mJ
$R_{thjh}$		–	–	1,2	K/W
Temperature Sensor					
$R_{TS}$	$T = 25 / 100 \text{ }^\circ\text{C}$		1000 / 1670		$\Omega$
Mechanical Data					
$M_1$	case to heatsink, SI Units	2,5	–	3,5	Nm
Case	mechanical outline see pages B 16 –13 and B 16 – 14		M8a		

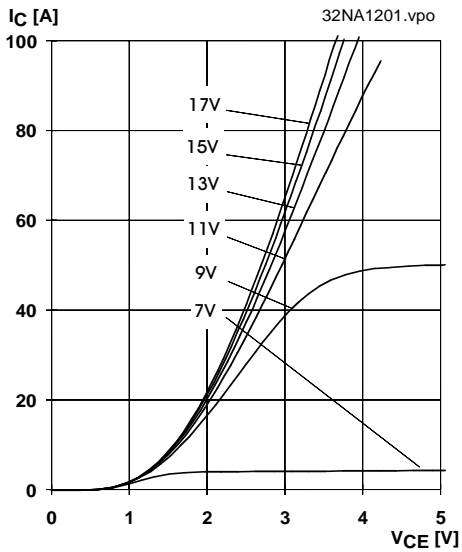

Fig. 1 Typ. output characteristic,  $t_p = 80 \mu s$ ;  $25 \text{ }^\circ\text{C}$

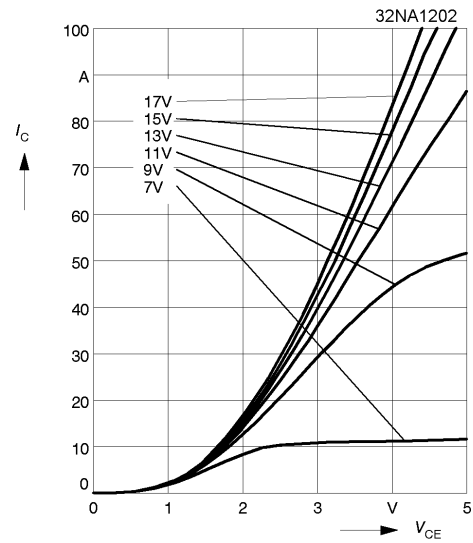

Fig. 2 Typ. output characteristic,  $t_p = 80 \mu s$ ;  $125 \text{ }^\circ\text{C}$

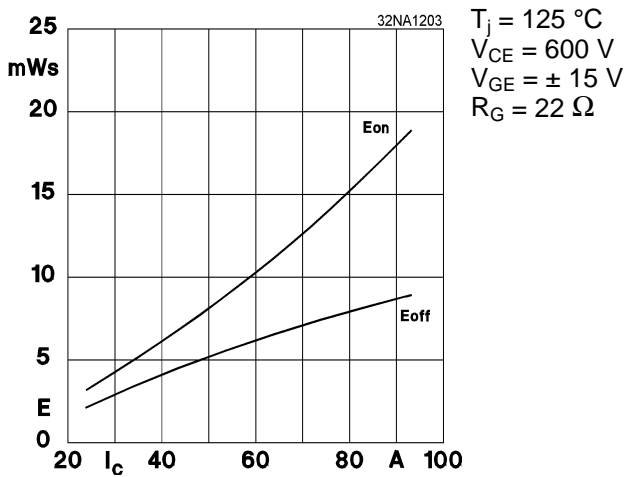

Fig. 3 Turn-on /-off energy =  $f(I_c)$

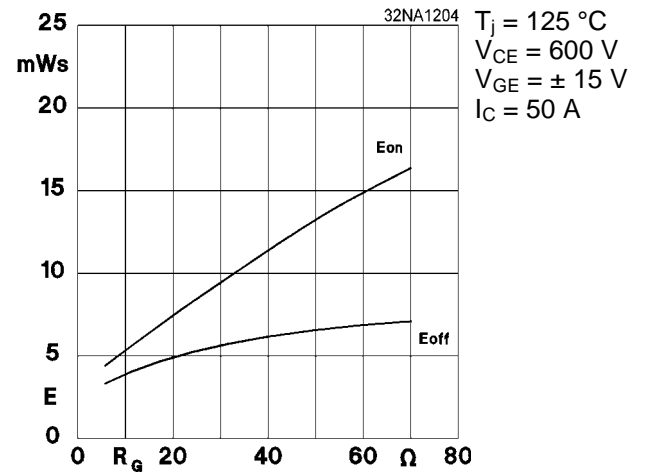

Fig. 4 Turn-on /-off energy =  $f(R_G)$

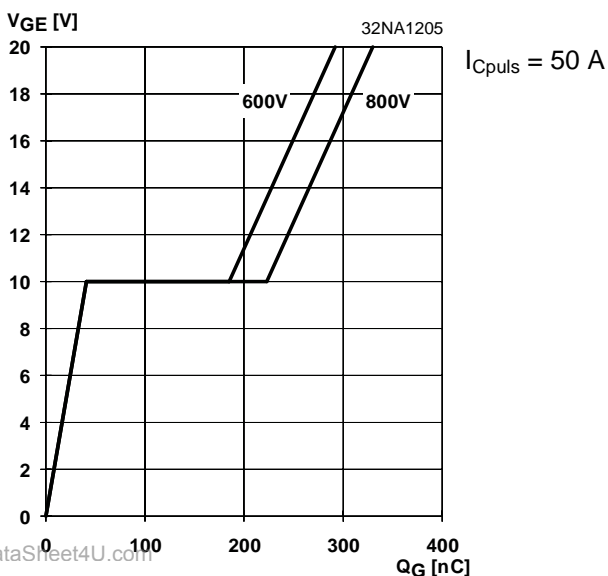

Fig. 5 Typ. gate charge characteristic

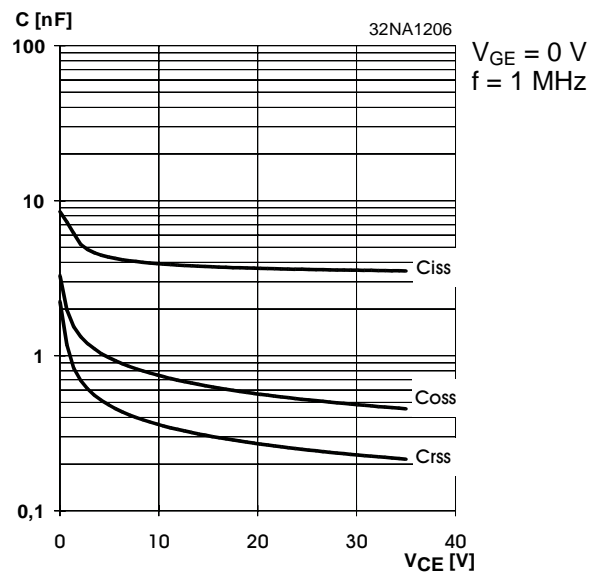

Fig. 6 Typ. capacitances vs.  $V_{CE}$

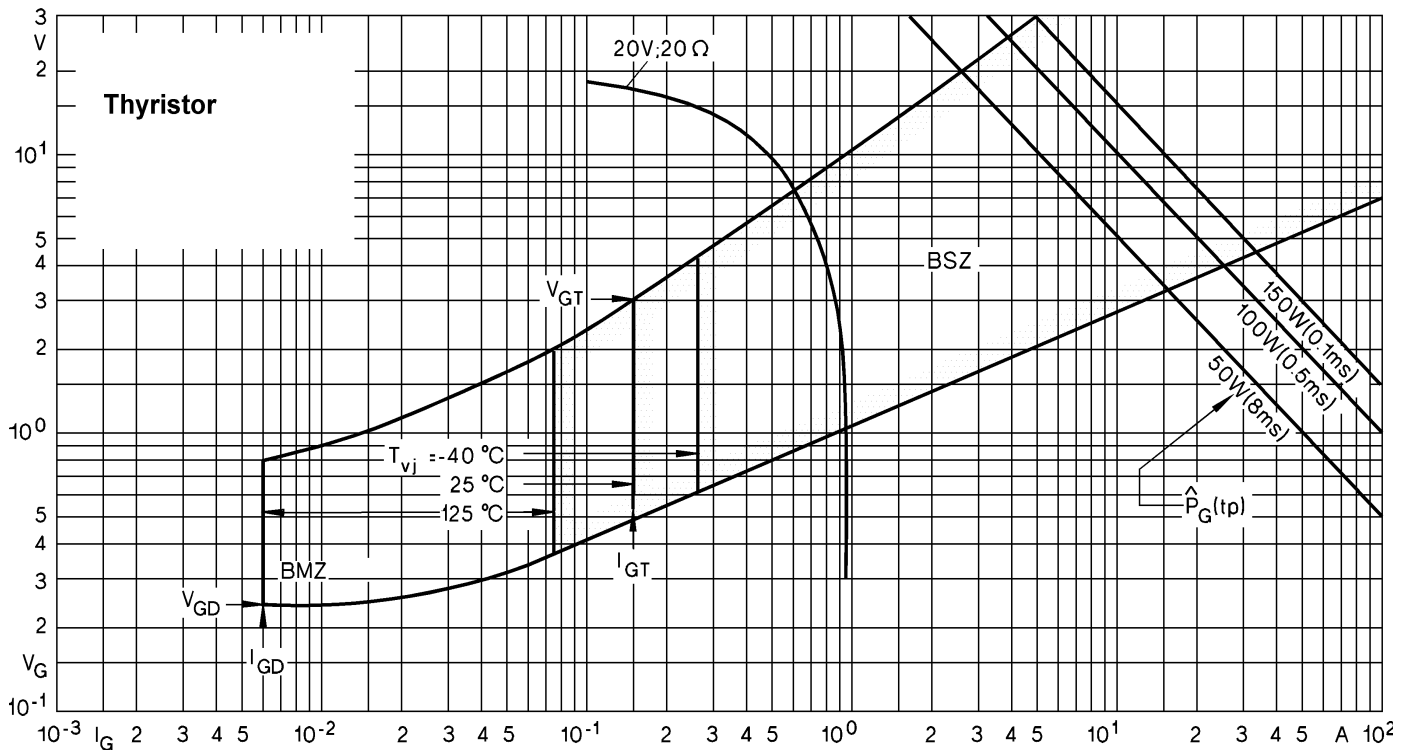

Fig. 7 Gate trigger characteristics

# MiniSKiiP 1200 V

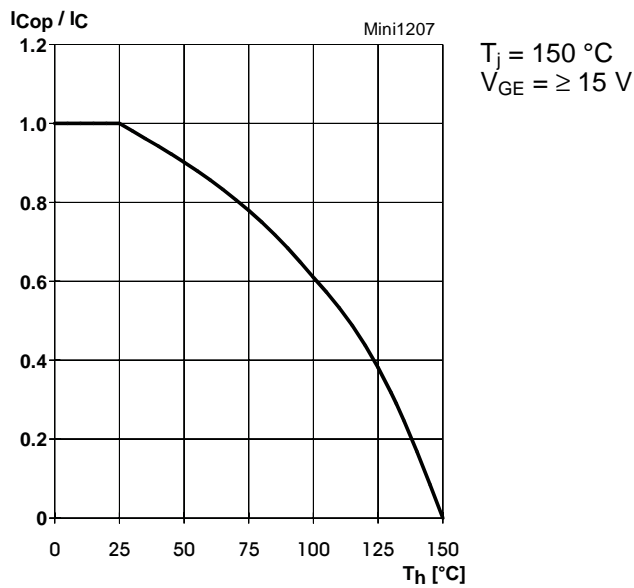

Fig. 7 Rated current of the IGBT  $I_{COp} / I_C = f(T_h)$

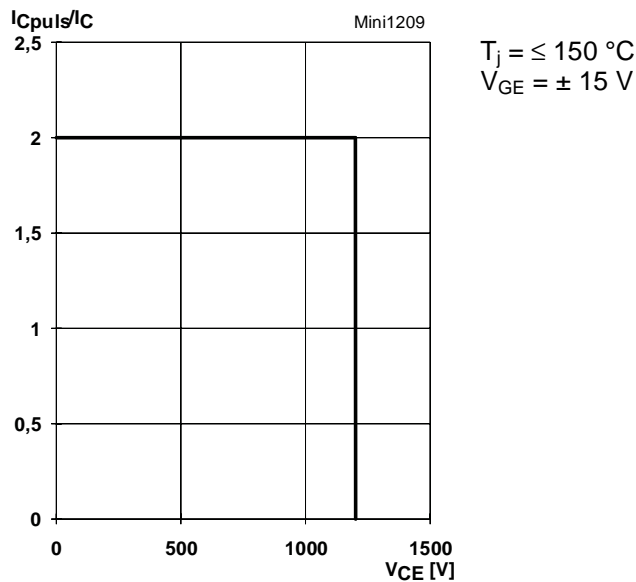

Fig. 9 Turn-off safe operating area (RBSOA) of the IGBT

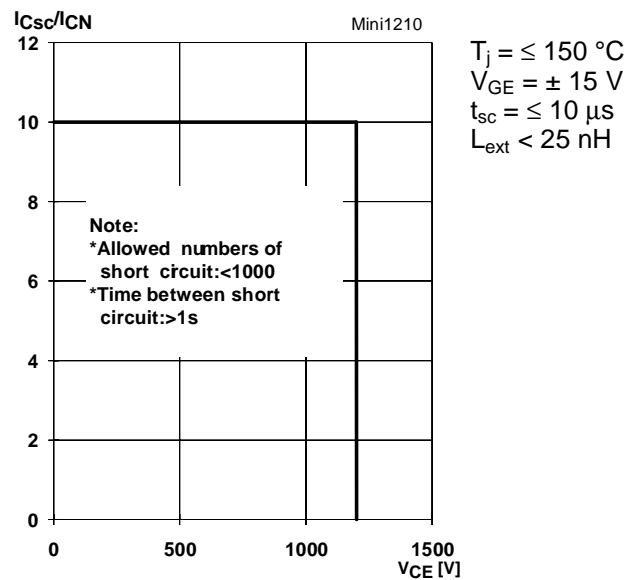

Fig. 10 Safe operating area at short circuit of the IGBT

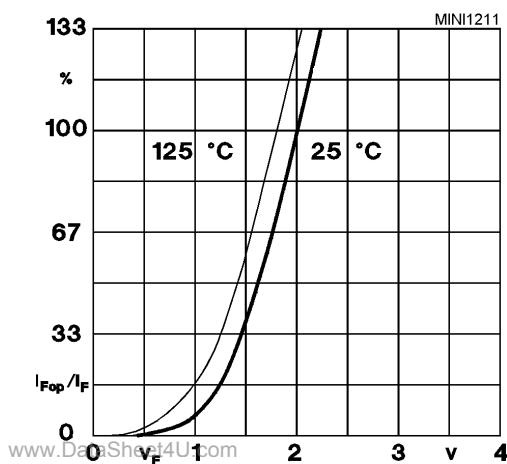

Fig. 11 Typ. freewheeling diode forward characteristic

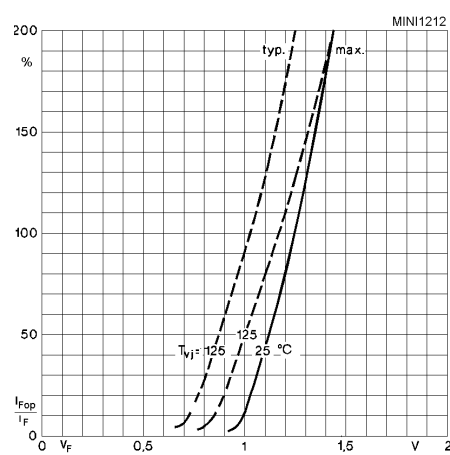

Fig. 12 Forward characteristic of the input bridge diode

### MiniSKiiP 8

Input bridge part

- SKiiP 82 ANB 08
- SKiiP 83 ANB 08
- SKiiP 81 ANB 15
- SKiiP 82 ANB 15
- SKiiP 83 ANB 15
- SKiiP 83 AHB 15
- SKiiP 83 ATB 15

Circuit ANB  
Case M8a

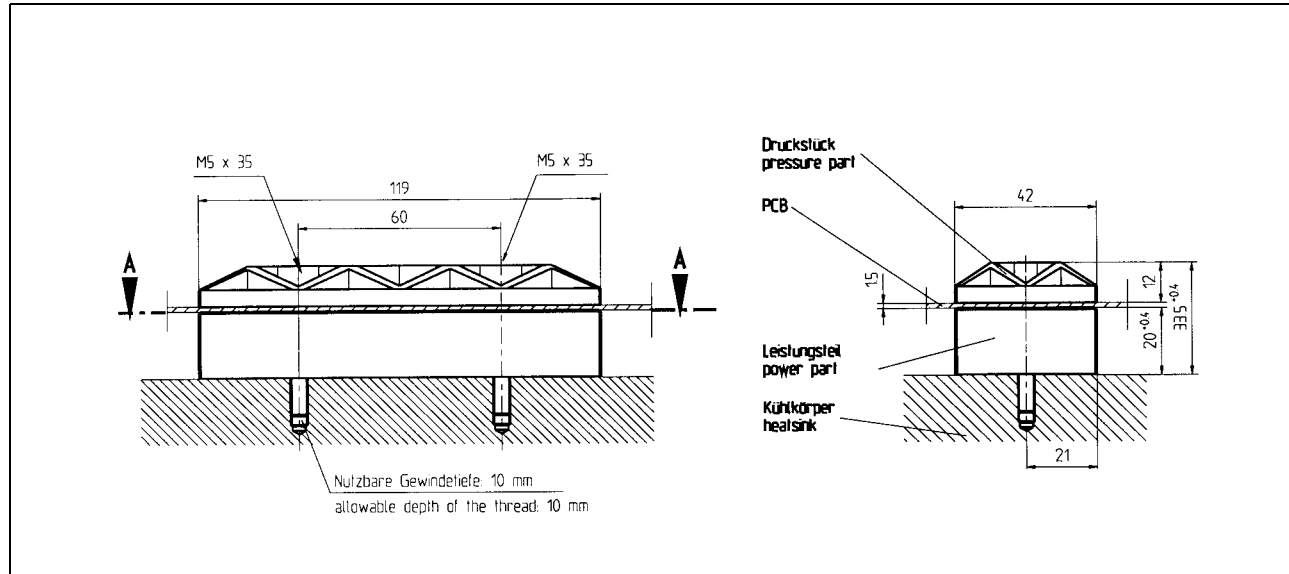
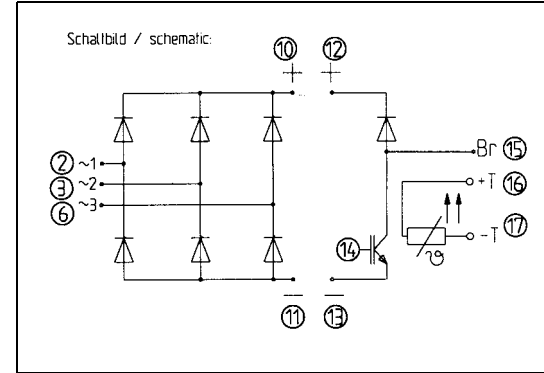

### MiniSKiiP 8

Input bridge part

- SKiiP 82 ANB 08
- SKiiP 83 ANB 08
- SKiiP 81 ANB 15
- SKiiP 82 ANB 15
- SKiiP 83 ANB 15
- SKiiP 83 AHB 15
- SKiiP 83 ATB 15

Case M8a  
Layout and connections for the customer's printed circuit board

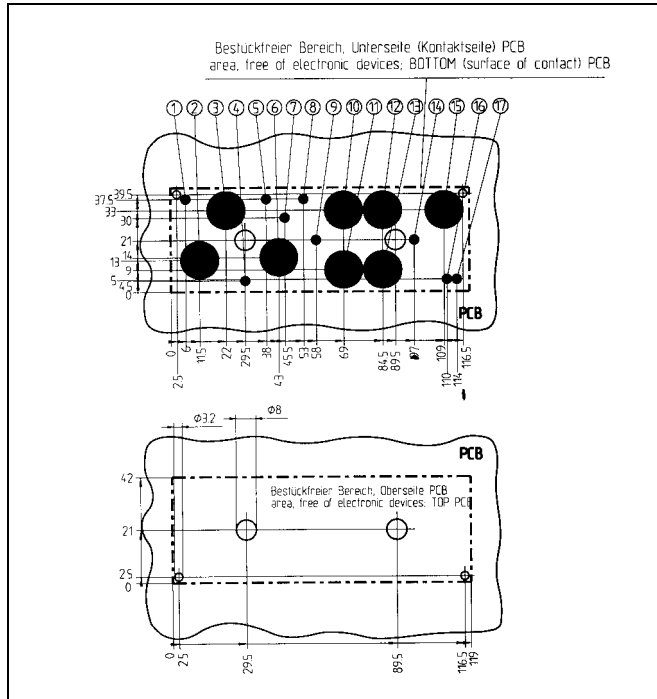

Circuit AHB

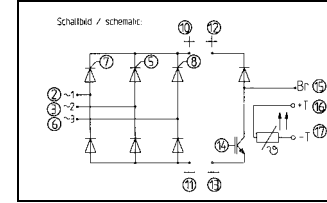

Circuit ATB

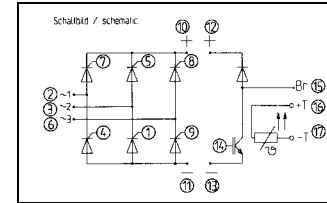

Pin	Connection			
	Diode bridge ANB	Halfcontrolled AHB	Thyristor bridge ATB	
1	reserved	reserved		G2 Bot
2	~ 1	~ 1	~ 1	
3	~ 2	~ 2	~ 2	
4	reserved	reserved		G1 Bot
5	reserved	G2 Top		G2 Top
6	~ 3	~ 3	~ 3	
7	reserved	G1 Top		G1 Top
8	reserved	G3 Top		G3 Top
9	reserved	reserved		G3 Bot
10	+	+	+	
11	-	-	-	
12	+	+	+	
13	-	-	-	
14	Gate Br	Gate Br		Gate Br
15	Br	Br	Br	
16	T +	T +	T +	
17	T -	T -	T -	