

Cree® 5-mm Blue and Green Round LED C503B-BAS/BAN/GAS/GAN (15 degrees) C503B-BCS/BCN/GCS/GCN (30 degrees) Data Sheet

Round LEDs offer superior light output for excellent readability in sunlight and dependable performance. They provide extremely stable light output over long periods of time.

These lamps are made with an advanced optical-grade epoxy offering superior high-temperature and high-moisture-resistance performance in outdoor signal and sign applications.

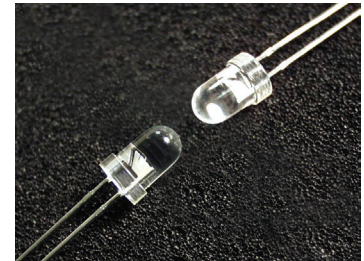

- FEATURES
- Size (mm): 5
- Color and Typical Dominant Wavelength (nm):
 - » Blue (470)
 - » Green (527)
- Luminous Intensity (mcd)
 - » C503B-BAS/BAN (5860-32900)
 - » C503B-BCS/BCN (2130-12000)
 - » C503B-GAS/GAN (16800-90500)
 - » C503B-GCS/GCN (5860-32900)
- Viewing Angle:
 - » C503B-BAS/BAN/GAS/GAN: 15 degrees
 - » C503B-BCS/BCN/GCS/GCN: 30 degrees
- Lead-Free
- RoHS-Compliant

APPLICATIONS

- Electronic Signs & Signals (ESS)
- Motorway Signs
- Variable-Message Sign (VMS)
- Advertising Signs
- Petrol Signs
- Amusement



Absolute Maximum Ratings ($T_A = 25^\circ\text{C}$)

Items	Symbol	Absolute Maximum Rating	Unit
		Blue/Green	
Forward Current	I_F	25	mA
Peak Forward Current ^{Note1}	I_{FP}	100	mA
Reverse Voltage	V_R	5	V
Power Dissipation	P_D	100	mW
Operation Temperature	T_{opr}	-40 ~ +95	$^\circ\text{C}$
Storage Temperature	T_{stg}	-40 ~ +100	$^\circ\text{C}$
Lead Soldering Temperature	T_{sol}	Max. 260 $^\circ\text{C}$ for 3 sec. max. (3 mm from the base of the epoxy bulb)	

Note:

1. Pulse width ≤ 0.1 msec, duty $\leq 1/10$.

Typical Electrical & Optical Characteristics ($T_A = 25^\circ\text{C}$)

Characteristics	Color	Symbol	Condition	Unit	Minimum	Typical	Maximum	
Forward Voltage	Blue/Green	V_F	$I_F = 20$ mA	V		3.2	4.0	
Reverse Current	Blue/Green	I_R	$V_R = 5$ V	μA			100	
Dominant Wave-length	Blue	λ_D	$I_F = 20$ mA	nm	465	470	480	
	Green	λ_D	$I_F = 20$ mA	nm	520	527	535	
Luminous Intensity	Blue	C503B-BAS/BAN (15 degree)	I_V	$I_F = 20$ mA	mcd	5860	11000	
		C503B-BCS/BCN (30 degree)	I_V	$I_F = 20$ mA	mcd	2130	4100	
	Green	C503B-GAS/GAN (15 degree)	I_V	$I_F = 20$ mA	mcd	16800	34000	
		C503B-GCS/GCN (30 degree)	I_V	$I_F = 20$ mA	mcd	5860	12500	
50% Power Angle	C503B-BAS/BAN/GAS/GAN		$2\theta_{1/2}$	$I_F = 20$ mA	deg		15	
	C503B-BCS/BCN/GCS/GCN		$2\theta_{1/2}$	$I_F = 20$ mA	deg		30	



Intensity Bin Limit ($I_f = 20 \text{ mA}$)

Blue

C503B-BAS/BAN (15 degree)

Bin Code	Min.(mcd)	Max.(mcd)
Y0	5860	8200
Z0	8200	12000
A0	12000	16800
B0	16800	23500
C0	23500	32900

C503B-BCS/BCN (30 degree)

Bin Code	Min.(mcd)	Max.(mcd)
V0	2130	3000
W0	3000	4180
X0	4180	5860
Y0	5860	8200
Z0	8200	12000

Green

C503B-GAS/GAN (15 degree)

Bin Code	Min.(mcd)	Max.(mcd)
B0	16800	23500
C0	23500	32900
D0	32900	46100
E0	46100	64600
F0	64600	90500

C503B-GCS/GCN (30 degree)

Bin Code	Min.(mcd)	Max.(mcd)
Y0	5860	8200
Z0	8200	12000
A0	12000	16800
B0	16800	23500
C0	23500	32900

Tolerance of measurement of luminous intensity is $\pm 15\%$.

Color Bin Limit ($I_f = 20 \text{ mA}$)

Blue

Bin Code	Min.(nm)	Max.(nm)
B4	465	470
B5	470	475
B6	475	480

Green

Bin Code	Min.(nm)	Max.(nm)
G7	520	525
G8	525	530
G9	530	535

Tolerance of measurement of dominant wavelength is $\pm 1 \text{ nm}$.



Order Code Table*

Blue (15 degrees)

Color	Kit Number	Viewing Angle	Luminous Intensity (mcd)		Dominant Wavelength				Package	Standoff
			Min.	Max.	Color Bin	Min. (nm)	Color Bin	Max. (nm)		
Blue	C503B-BAS-CY0C0461	15	5860	32900	B4	465	B6	480	Bulk	Yes
Blue	C503B-BAS-CY0Z0451	15	5860	12000	B4	465	B5	475	Bulk	Yes
Blue	C503B-BAS-CZ0A0451	15	8200	16800	B4	465	B5	475	Bulk	Yes
Blue	C503B-BAN-CY0C0461	15	5860	32900	B4	465	B6	480	Bulk	No
Blue	C503B-BAN-CY0Z0451	15	5860	12000	B4	465	B5	475	Bulk	No
Blue	C503B-BAN-CZ0A0451	15	8200	16800	B4	465	B5	475	Bulk	No
Blue	C503B-BAS-CY0C0462	15	5860	32900	B4	465	B6	480	Ammo	Yes
Blue	C503B-BAS-CY0Z0452	15	5860	12000	B4	465	B5	475	Ammo	Yes
Blue	C503B-BAS-CZ0A0452	15	8200	16800	B4	465	B5	475	Ammo	Yes
Blue	C503B-BAN-CY0C0462	15	5860	32900	B4	465	B6	480	Ammo	No
Blue	C503B-BAN-CY0Z0452	15	5860	12000	B4	465	B5	475	Ammo	No
Blue	C503B-BAN-CZ0A0452	15	8200	16800	B4	465	B5	475	Ammo	No

Blue (30 degrees)

Color	Kit Number	Viewing Angle	Luminous Intensity (mcd)		Dominant Wavelength				Package	Standoff
			Min.	Max.	Color Bin	Min. (nm)	Color Bin	Max. (nm)		
Blue	C503B-BCS-CV0Z0461	30	2130	12000	B4	465	B6	480	Bulk	Yes
Blue	C503B-BCS-CV0W0451	30	2130	4180	B4	465	B5	475	Bulk	Yes
Blue	C503B-BCS-CW0X0451	30	3000	5860	B4	465	B5	475	Bulk	Yes
Blue	C503B-BCS-CX0Y0451	30	4180	8200	B4	465	B5	475	Bulk	Yes
Blue	C503B-BCN-CV0Z0461	30	2130	12000	B4	465	B6	480	Bulk	No
Blue	C503B-BCN-CV0W0451	30	2130	4180	B4	465	B5	475	Bulk	No
Blue	C503B-BCN-CW0X0451	30	3000	5860	B4	465	B5	475	Bulk	No
Blue	C503B-BCN-CX0Y0451	30	4180	8200	B4	465	B5	475	Bulk	No
Blue	C503B-BCS-CV0Z0462	30	2130	12000	B4	465	B6	480	Ammo	Yes
Blue	C503B-BCS-CV0W0452	30	2130	4180	B4	465	B5	475	Ammo	Yes
Blue	C503B-BCS-CW0X0452	30	3000	5860	B4	465	B5	475	Ammo	Yes
Blue	C503B-BCS-CX0Y0452	30	4180	8200	B4	465	B5	475	Ammo	Yes
Blue	C503B-BCN-CV0Z0462	30	2130	12000	B4	465	B6	480	Ammo	No
Blue	C503B-BCN-CV0W0452	30	2130	4180	B4	465	B5	475	Ammo	No
Blue	C503B-BCN-CW0X0452	30	3000	5860	B4	465	B5	475	Ammo	No
Blue	C503B-BCN-CX0Y0452	30	4180	8200	B4	465	B5	475	Ammo	No



Green (15 degrees)

Color	Kit Number	Viewing Angle	Luminous Intensity (mcd)		Dominant Wavelength				Package	Standoff
			Min.	Max.	Color Bin	Min. (nm)	Color Bin	Max. (nm)		
Green	C503B-GAS-CB0F0791	15	16800	90500	G7	520	G9	535	Bulk	Yes
Green	C503B-GAS-CB0C0781	15	16800	32900	G7	520	G8	530	Bulk	Yes
Green	C503B-GAS-CC0D0781	15	23500	46100	G7	520	G8	530	Bulk	Yes
Green	C503B-GAS-CB0C0891	15	16800	32900	G8	525	G9	535	Bulk	Yes
Green	C503B-GAS-CC0D0891	15	23500	46100	G8	525	G9	535	Bulk	Yes
Green	C503B-GAN-CB0F0791	15	16800	90500	G7	520	G9	535	Bulk	No
Green	C503B-GAN-CB0C0781	15	16800	32900	G7	520	G8	530	Bulk	No
Green	C503B-GAN-CC0D0781	15	23500	46100	G7	520	G8	530	Bulk	No
Green	C503B-GAN-CB0C0891	15	16800	32900	G8	525	G9	535	Bulk	No
Green	C503B-GAN-CC0D0891	15	23500	46100	G8	525	G9	535	Bulk	No
Green	C503B-GAS-CB0F0792	15	16800	90500	G7	520	G9	535	Ammo	Yes
Green	C503B-GAS-CB0C0782	15	16800	32900	G7	520	G8	530	Ammo	Yes
Green	C503B-GAS-CC0D0782	15	23500	46100	G7	520	G8	530	Ammo	Yes
Green	C503B-GAS-CB0C0892	15	16800	32900	G8	525	G9	535	Ammo	Yes
Green	C503B-GAS-CC0D0892	15	23500	46100	G8	525	G9	535	Ammo	Yes
Green	C503B-GAN-CB0F0792	15	16800	90500	G7	520	G9	535	Ammo	No
Green	C503B-GAN-CB0C0782	15	16800	32900	G7	520	G8	530	Ammo	No
Green	C503B-GAN-CC0D0782	15	23500	46100	G7	520	G8	530	Ammo	No
Green	C503B-GAN-CB0C0892	15	16800	32900	G8	525	G9	535	Ammo	No
Green	C503B-GAN-CC0D0892	15	23500	46100	G8	525	G9	535	Ammo	No



Green (30 degrees)

Color	Kit Number	Viewing Angle	Luminous Intensity (mcd)		Dominant Wavelength				Package	Standoff
			Min.	Max.	Color Bin	Min. (nm)	Color Bin	Max. (nm)		
Green	C503B-GCS-CY0C0791	30	5860	32900	G7	520	G9	535	Bulk	Yes
Green	C503B-GCS-CY0Z0781	30	5860	12000	G7	520	G8	530	Bulk	Yes
Green	C503B-GCS-CZ0A0781	30	8200	16800	G7	520	G8	530	Bulk	Yes
Green	C503B-GCS-CY0Z0891	30	5860	12000	G8	525	G9	535	Bulk	Yes
Green	C503B-GCS-CZ0A0891	30	8200	16800	G8	525	G9	535	Bulk	Yes
Green	C503B-GCN-CY0C0791	30	5860	32900	G7	520	G9	535	Bulk	No
Green	C503B-GCN-CY0Z0781	30	5860	12000	G7	520	G8	530	Bulk	No
Green	C503B-GCN-CZ0A0781	30	8200	16800	G7	520	G8	530	Bulk	No
Green	C503B-GCN-CY0Z0891	30	5860	12000	G8	525	G9	535	Bulk	No
Green	C503B-GCN-CZ0A0891	30	8200	16800	G8	525	G9	535	Bulk	No
Green	C503B-GCS-CY0C0792	30	5860	32900	G7	520	G9	535	Ammo	Yes
Green	C503B-GCS-CY0Z0782	30	5860	12000	G7	520	G8	530	Ammo	Yes
Green	C503B-GCS-CZ0A0782	30	8200	16800	G7	520	G8	530	Ammo	Yes
Green	C503B-GCS-CY0Z0892	30	5860	12000	G8	525	G9	535	Ammo	Yes
Green	C503B-GCS-CZ0A0892	30	8200	16800	G8	525	G9	535	Ammo	Yes
Green	C503B-GCN-CY0C0792	30	5860	32900	G7	520	G9	535	Ammo	No
Green	C503B-GCN-CY0Z0782	30	5860	12000	G7	520	G8	530	Ammo	No
Green	C503B-GCN-CZ0A0782	30	8200	16800	G7	520	G8	530	Ammo	No
Green	C503B-GCN-CY0Z0892	30	5860	12000	G8	525	G9	535	Ammo	No
Green	C503B-GCN-CZ0A0892	30	8200	16800	G8	525	G9	535	Ammo	No

Notes:

- The above kit numbers represent order codes that include multiple intensity-bin and color-bin codes. Only one intensity-bin code and one color-bin code will be shipped on each bulk or ammo. Single intensity-bin codes and single color-bin codes will not be orderable.
- Please refer to the "Cree LED Lamp Reliability Test Standards" document for reliability test conditions.
- Please refer to the "Cree LED Lamp Soldering & Handling" document for information about how to use this LED product safely.

Graphs

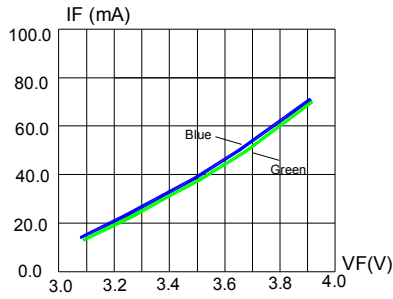

FIG.1 FORWARD CURRENT VS. FORWARD VOLTAGE.

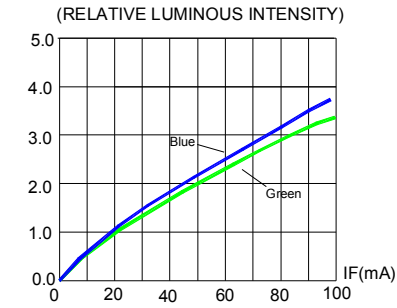

FIG.2 RELATIVE LUMINOUS INTENSITY VS. FORWARD CURRENT

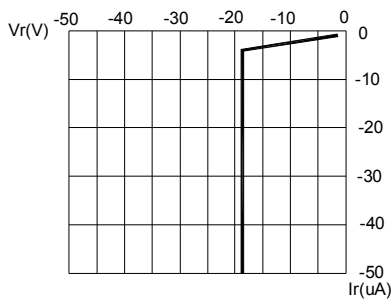

FIG.3 BLUE&GREEN REVERSE CURRENT VS. REVERSE VOLTAGE.

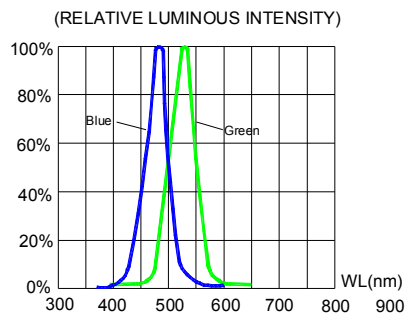

FIG.4 RELATIVE LUMINOUS INTENSITY VS. WAVELENGTH.

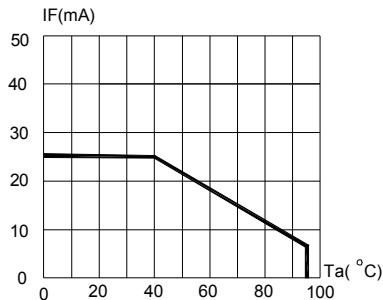

FIG.5 BLUE & GREEN MAXIMUM FORWARD DC CURRENT VS AMBIENT TEMPERATURE ($T_{jmax}=105^{\circ}C$)

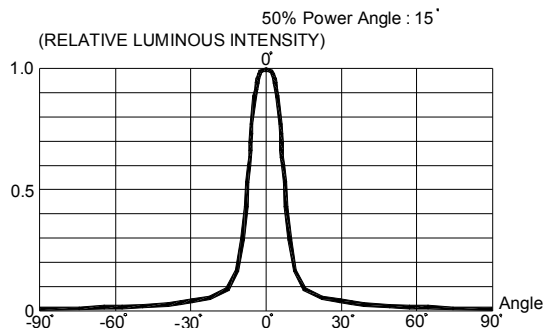

FIG.6 FAR FIELD PATTERN

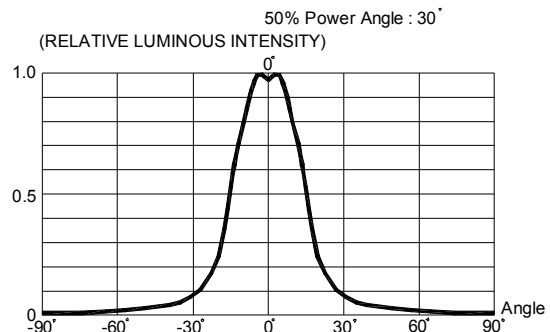

FIG.7 FAR FIELD PATTERN

The above data are collected from statistical figures that do not necessarily correspond to the actual parameters of each single LED. Hence, these data will be changed without further notice.

Mechanical Dimensions

All dimensions are in mm. Tolerance is ± 0.25 mm unless otherwise noted.

An epoxy meniscus may extend about 1.5 mm down the leads.

Burr around bottom of epoxy may be 0.5 mm max.

C503B-BAN/GAN/BCN/GCN:

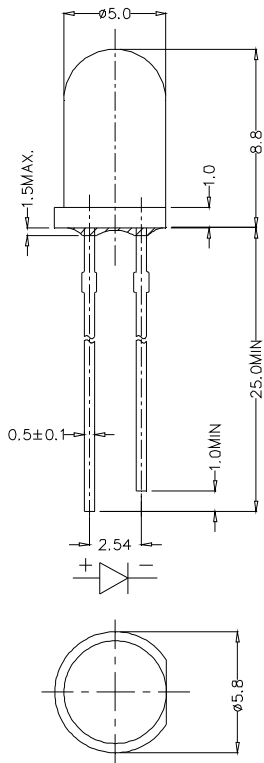

C503B-BAS/GAS:

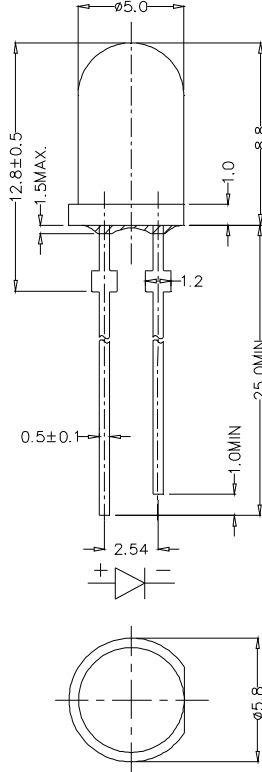

C503B-BCS/GCS:

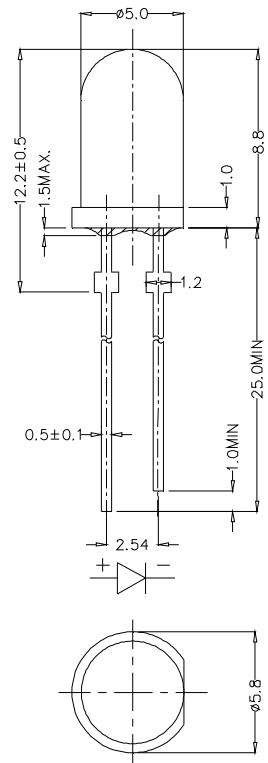



Kit Number System

Cree LED lamps are tested and sorted into performance bins. A bin is specified by ranges of color, forward voltage, and brightness. Sorted LEDs are packaged for shipping in various convenient options. Please refer to the "Cree LED Lamp Packaging Standard" document for more information about shipping and packaging options.

Cree LEDs are sold by order codes in combinations of bins called kits. Order codes are configured in the following manner:

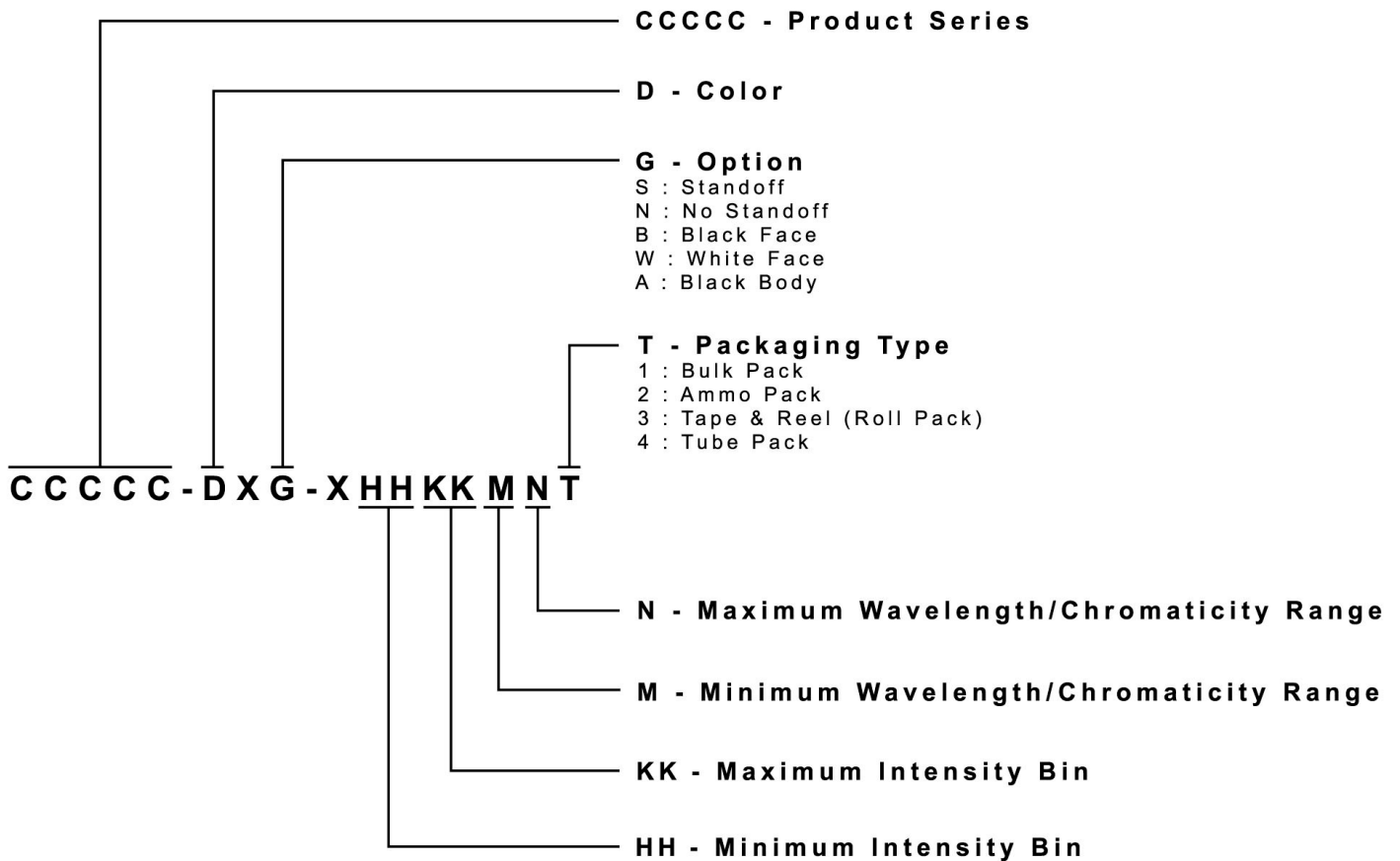

Package

Features:

- The LEDs are packed in cardboard boxes after packaging in normal or anti-electrostatic bags.
- Cardboard boxes will be used to protect the LEDs from mechanical shock during transportation.
- The boxes are not water-resistant, and they must be kept away from water and moisture.
- The Bulk or Ammo Pack types of packaging.
- Max 500 pcs per bulk and Max 2500 pcs per ammo.

Bulk Pack Packaging Type:

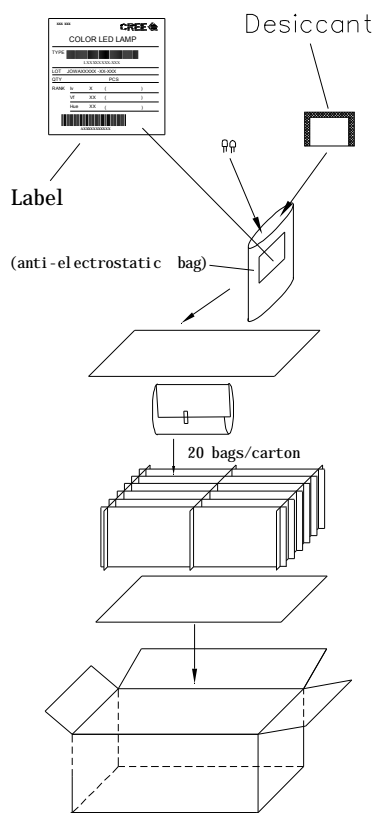

Ammo Pack Packaging Type:

