

SMX-5F-QA SMX-5F-QB

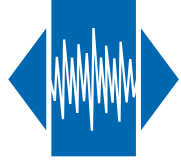

Low profile SMD Crystal

Features

- Applications: telecommunications, audio, automotive, instruments
- Pin compatible to several plastic moulded Crystals
- High reliable, low cost crystal
- Reflow soldering @ 260 °C

Parameter	Specification	
Frequency range	3.5 ~ 40 MHz fundamental 32 ~ 70 MHz	3 rd overtone
Mode of oscillation	AT-cut	BT-cut on request
Standard frequencies	3.6864, 4.00, 5.00, 6.776, 8.00, 9.8304, 10.00, 11.0592 16.00, 18.432, 20.00, 24.00 & 48.00 MHz	
Frequency tolerance	±10 ~ ± 50 ppm	@ +25 °C
Frequency stability	±10 ~ ±100 ppm	vs. operating temperature range
Aging	±2 ppm	1 st year
Load capacitance	series or parallel resonance (CL = 8 ~ 32 pF)	
Equivalent series resistance (ESR)	< 75 Ω < 12 Ω	3.6864 MHz 24.00 MHz
Drive level	100 μW	
Operating temperature range	-20 ~ +70 °C -40 ~ +85 °C -40 ~ +125 °C	commercial application industrial application automotive application
Storage temperature range	-55 ~ +125 °C	
Packaging unit	tape & reel	1'000 pieces
Customer specifications on request		

SMX-5F-QA

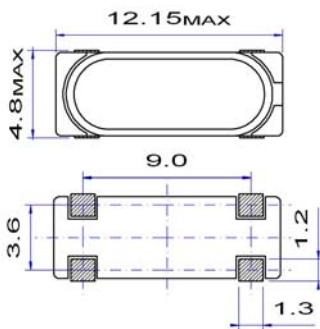

Pin function

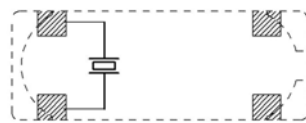

Example for soldering pattern

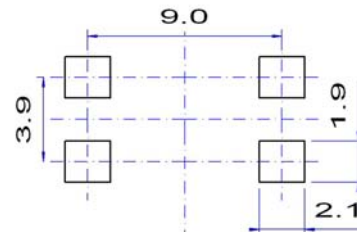

Do not design any conductive path between the pattern

SMX-5F-QB

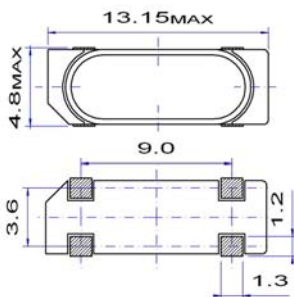

Pin function

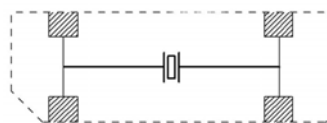

Example for IR reflow soldering temperature

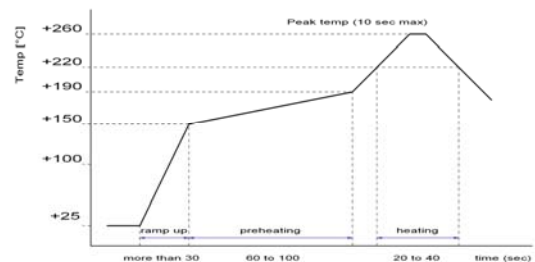

2002/95/EC RoHS compliant