



STLVDS051

HIGH SPEED DIFFERENTIAL LINE DRIVERS AND RECEIVERS

- MEETS OR EXCEEDS THE REQUIREMENTS OF ANSI EIA/TIA-644-1995 STANDARD
- SIGNALING RATES UP TO 400Mbit/s
- BUS TERMINAL ESD EXCEEDS 6KV
- OPERATES FROM A SINGLE 3.3V SUPPLY
- LOW-VOLTAGE DIFFERENTIAL SIGNALING WITH TYPICAL OUTPUT VOLTAGE OF 350mV AND A 100Ω LOAD
- PROPAGATION DELAY TIMES:
DRIVER: 2ns (TYP)
RECEIVER: 3ns (TYP)
- POWER DISSIPATION AT 200MHz:
DRIVER: 25mW (TYP)
RECEIVER: 60mW (TYP)
- LVTTTL INPUT LEVELS ARE 5V TOLERANT
- RECEIVER HAS OPEN-CIRCUIT FAIL-SAFE

DESCRIPTION

The STLVDS051 is differential line drivers and receivers that use low-voltage differential signaling (LVDS) to achieve signaling rate as high as 400Mbps.

The EIA/TIA-644 standard compliant electrical interface provides a minimum differential output voltage magnitude of 247 mV into a 100 Ω load and receipt of 100 mV signals with up to 1 V of

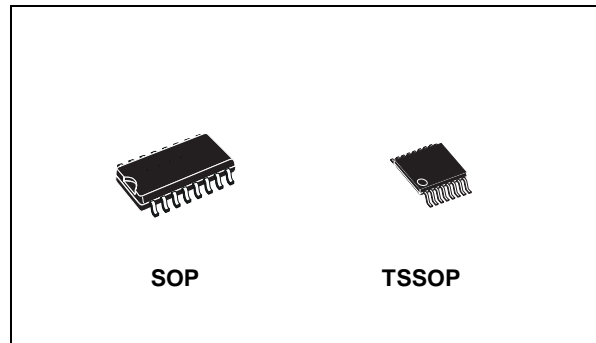

ground potential difference between a transmitter and receiver.

The intended application of this device an signaling technique is for point-to-point baseband data transmission over controlled impedance media of approximately 100 Ω characteristic impedance.

The transmission media may be printed-circuit board traces, backplanes, or cables. (Note: The ultimate rate and distance of data transfer is dependent upon the attenuation characteristics of the media, the noise coupling to the environment, and other application specific characteristics).

ORDERING CODES

Type	Temperature Range	Package	Comments
STLVDS051BD	-40 to 85 °C	SO-16 (Tube)	50 parts per tube / 20 tube per box
STLVDS051BDR	-40 to 85 °C	SO-16 (Tape & Reel)	2500 parts per reel
STLVDS051BTR	-40 to 85 °C	TSSOP16 (Tape & Reel)	2500 parts per reel

STLVDS051

PIN CONFIGURATION

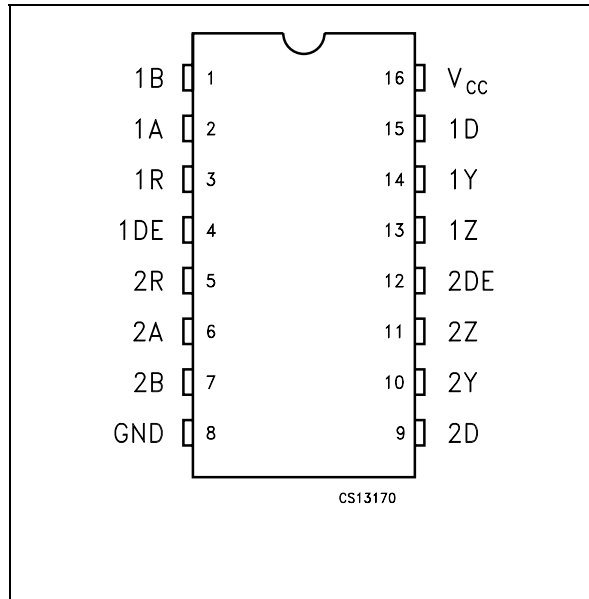

FUNCTIONAL DIAGRAM

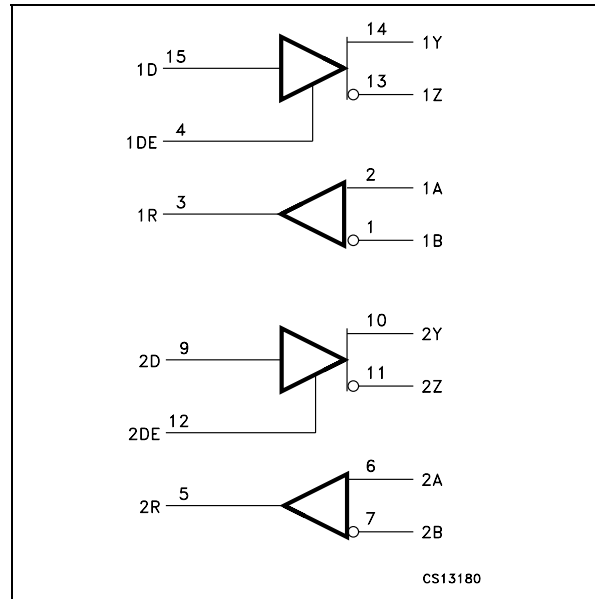

PIN DESCRIPTION

PIN N°	SYMBOL	NAME AND FUNCTION
1, 2, 6, 7	1A, 1B, 2A, 2B	Receiver Inputs
3, 5	1R, 2R	Receiver Outputs
4, 12	1DE, 2DE	Driver Enable
9, 15	2D, 1D	Driver Inputs
10, 11, 13, 14	2Y, 2Z, 1Y, 1Z	Driver Outputs
8	GND	Ground
16	V _{CC}	Supply Voltage

TRUTH TABLE FOR RECEIVER

$V_{ID}=V_A-V_B$	R
$V_{ID} \geq 100\text{mV}$	H
$-100\text{mV} < V_{ID} < 100\text{mV}$?
$V_{ID} \leq -100\text{mV}$	L
OPEN	H

TRUTH TABLE FOR DRIVER

D	DE	Y	Z
L	H	L	H
H	H	H	L
OPEN	H	L	H
X	L	Z	Z

L=Low level, H=High Level, X=Don't care, Z= High Impedance

ABSOLUTE MAXIMUM RATINGS

Symbol	Parameter		Value	Unit
V _{CC}	Supply Voltage		-0.5 to 4	V
V _I	Voltage Range	D, R, DE	-0.5 to 6	V
ESD	ESD Protection Voltage (HBM)	Y, Z, A, B, and GND	± 6	KV
		All Pins	± 3	
T _{stg}	Storage Temperature Range		-65 to +150	°C

Absolute Maximum Ratings are those values beyond which damage to the device may occur. Functional operation under these condition is not implied.

RECOMMENDED OPERATING CONDITIONS

Symbol	Parameter	Min.	Typ.	Max.	Unit
V_{CC}	Supply Voltage	3.0	3.3	3.6	V
V_{IH}	HIGH Level Input Voltage	2.0			V
V_{IL}	LOW Level Input Voltage			0.8	V
$ V_{ID} $	Magnitude Of Differential Input Voltage	0.1		0.6	V
V_{IC}	Common Mode Input Voltage	$ V_{ID} /2$		$24 \cdot V_{ID} /2$	V
				$V_{CC}-0.8$	
T_A	Operating Temperature Range	-40		85	°C

ELECTRICAL CHARACTERISTICS (Typical values are at $T_A = 25^\circ\text{C}$, $V_{CC} = 3.3\text{V} \pm 10\%$, $T_A = -40$ to 85°C unless otherwise specified)

Symbol	Parameter	Test Conditions	Min.	Typ.	Max.	Unit
I_{CC}	Supply Current	Drivers enabled, No Receivers load, Driver $R_L=100\Omega$		12	20	mA
		Drivers Disabled, No load		4	6	

DRIVER ELECTRICAL CHARACTERISTICS (Typical values are at $T_A = 25^\circ\text{C}$, $V_{CC} = 3.3\text{V} \pm 10\%$, $T_A = -40$ to 85°C unless otherwise specified)

Symbol	Parameter	Test Conditions	Min.	Typ.	Max.	Unit
$ V_{OD} $	Differential Output Voltage Magnitude	$R_L = 100\Omega$	247	340	454	mV
$\Delta V_{OD} $	Change in Differential Output Voltage Magnitude Between Logic States	$R_L = 100\Omega$	-50		50	mV
$\Delta V_{OC(SS)}$	Change in Steady-state Common Mode Output Voltage Between Logic States		-50		50	mV
$V_{OC(SS)}$	Steady-state Common Mode Output Voltage		1.125	1.2	1.375	V
$V_{OC(PP)}$	Peak to Peak Common mode Output Voltage			50	150	mV
I_{IH}	High Level Input Current	$V_{IH} = 5\text{V}$	DE	-0.5	-20	μA
			D		2	20
I_{IL}	Low Level Input Current	$V_{IL} = 0.8\text{V}$	DE	-0.5	-10	μA
			D		1	10
I_{OS}	Short Circuit Output Current	$V_{O(Y)}$ or $V_{O(Z)} = 0\text{V}$		6	10	mA
		$V_{OD} = 0$		4	10	mA
I_{OZ}	High Impedance Output Current	$V_O = 600\text{mV}$			± 1	μA
		$V_O = 0\text{V}$ or V_{CC}			± 1	μA
$I_{O(OFF)}$	Power OFF Output Current	$V_{CC} = 0\text{V}$ $V_O = 3.6\text{V}$			± 1	μA
C_{IN}	Input Capacitance			3		pF

STLVDS051

RECEIVER ELECTRICAL CHARACTERISTICS (Typical values are at $T_A = 25^\circ\text{C}$, $V_{CC} = 3.3\text{V} \pm 10\%$, $T_A = -40$ to 85°C unless otherwise specified)

Symbol	Parameter	Test Conditions	Min.	Typ.	Max.	Unit
V_{ITH+}	Positive-going Differential Input Voltage Threshold				100	mV
V_{ITH-}	Negative-going Differential Input Voltage Threshold		-100			mV
V_{OH}	High Level Output Voltage	$I_{OH} = -8\text{mA}$	2.4			V
V_{OL}	Low Level Output Voltage	$I_{OL} = 2\text{mA}$			0.4	V
I_I	Input Current (A or B Inputs)	$V_I = 0\text{V}$	-2	-11	-20	μA
		$V_I = 2.4\text{V}$	-1	-3		μA
$I_{I(OFF)}$	Power OFF Input Current (A or B Inputs)	$V_{CC} = 0\text{V}$			± 20	μA
I_{IH}	High Level Input Current (Enable)	$V_{IH} = 5\text{V}$			± 10	μA
I_{IL}	Low Level Input Current (Enable)	$V_{IL} = 0.8\text{V}$			± 10	μA
I_{OZ}	High Impedance Output Current	$V_O = 0$ or 5V			± 10	μA
C_{IN}	Input Capacitance			3		pF

DRIVER SWITCHING CHARACTERISTICS (Typical values are at $T_A = 25^\circ\text{C}$, $V_{CC} = 3.3\text{V} \pm 10\%$, $T_A = -40$ to 85°C unless otherwise specified)

Symbol	Parameter	Test Conditions	Min.	Typ.	Max.	Unit	
t_{PLH}	Propagation Delay Time, Low to High Output	$R_L = 100\Omega$ $C_L = 10\text{pF}$		2	2.7	ns	
t_{PHL}	Propagation Delay Time, High to Low Output			2	2.7	ns	
t_r	Differential Output Signal Rise Time				0.4	1	ns
t_f	Differential Output Signal Fall Time				0.4	1	ns
$t_{sk(P)}$	Pulse Skew ($ t_{THL} - t_{TLH} $) (note1)				50		ps
$t_{sk(O)}$	Channel-to-channel Output Skew (note2)				40		ps
t_{PZH}	Propagation Delay Time, High Impedance to High Level Output			6	10	ns	
t_{PZL}	Propagation Delay Time, High Impedance to Low Level Output			6	10	ns	
t_{PHZ}	Propagation Delay Time, High Level to High Impedance Output			3	10	ns	
t_{PLZ}	Propagation Delay Time, Low Level to High Impedance Output			3	10	ns	

RECEIVER SWITCHING CHARACTERISTICS (Typical values are at $T_A = 25^\circ\text{C}$, $V_{CC} = 3.3\text{V} \pm 10\%$, $T_A = -40$ to 85°C unless otherwise specified)

Symbol	Parameter	Test Conditions	Min.	Typ.	Max.	Unit
t_{PLH}	Propagation Delay Time, Low to High Output	$C_L = 10\text{pF}$		3.0	4.0	ns
t_{PHL}	Propagation Delay Time, High to Low Output			3.0	4.0	ns
t_r	Differential Output Signal Rise Time			0.6	1	ns
t_f	Differential Output Signal Fall Time			0.6	1	ns
$t_{sk(P)}$	Pulse Skew ($ t_{THL} - t_{TLH} $) (Note 1)				0.25	
t_{PZH}	Propagation Delay Time, High Impedance to High Level Output			2.5		ns
t_{PZL}	Propagation Delay Time, High Impedance to Low Level Output			2.5		ns
t_{PHZ}	Propagation Delay Time, High Level to High Impedance Output			7		ns
t_{PLZ}	Propagation Delay Time, Low Level to High Impedance Output			4		ns

Note 1: $t_{sk(P)}$ is the magnitude of the time difference between the high to low and low to high propagation delay times at an output

Note 2: $t_{sk(O)}$ is the magnitude of the time difference between the output of a single device with all their inputs connected together.

Note 3: $t_{sk(PP)}$ is the magnitude of the difference between any specified terminals of two devices when both devices operate with the same supply voltages, same temperature, and have identical packages and test circuit.

TYPICAL PERFORMANCE CHARACTERISTICS (unless otherwise specified $T_J = 25^\circ\text{C}$)

Figure 1 : Output Current vs Output High Voltage for Receiver

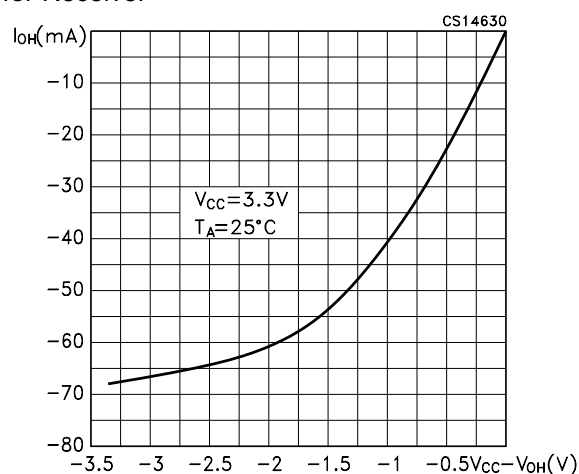

Figure 2 : Output Current vs Output Low Voltage for Receiver

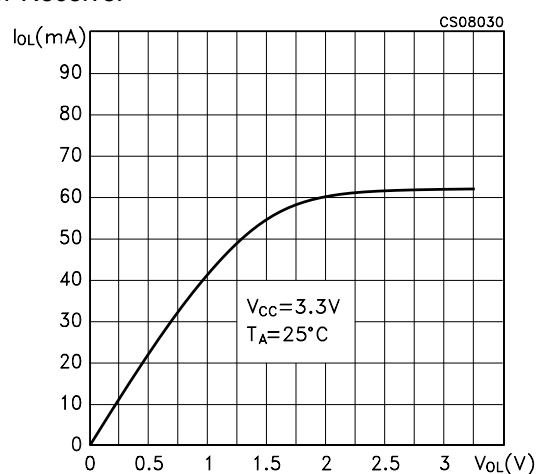

Figure 3 : Output Current vs Output High Voltage for Driver

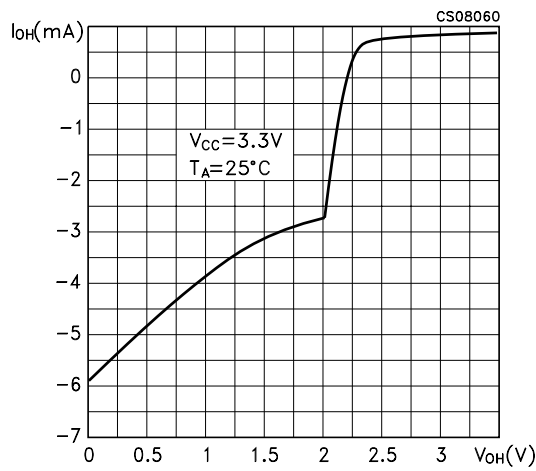

Figure 6 : Low to High Propagation Delay Time for Receiver

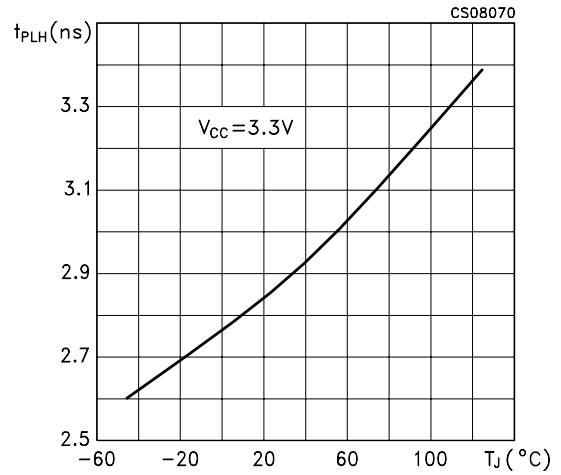

Figure 4 : Output Current vs Output Low Voltage for Driver

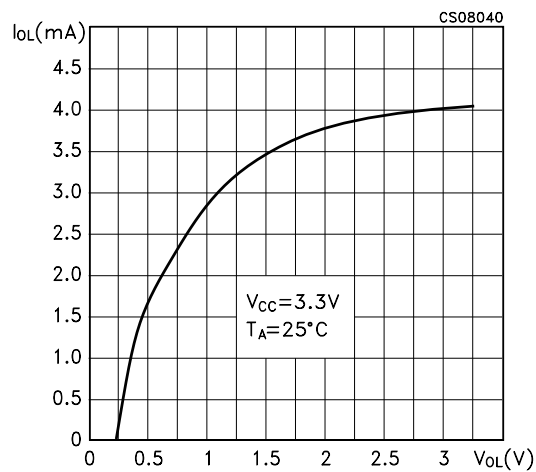

Figure 7 : High to Low Propagation Delay Time for Driver

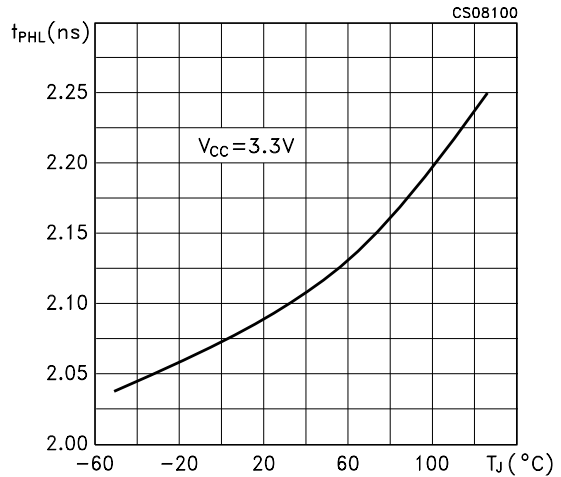

Figure 5 : High to Low Propagation Delay Time for Receiver

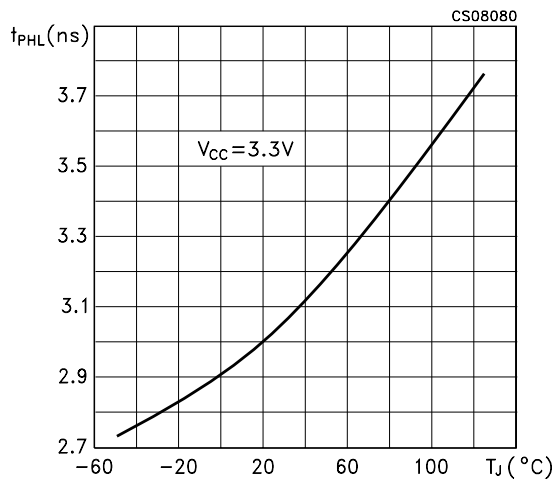
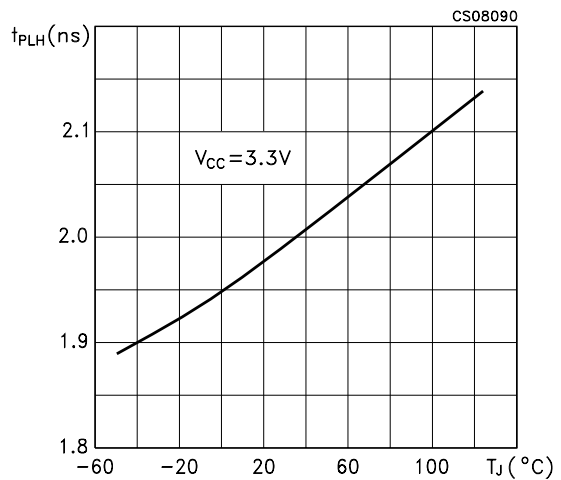
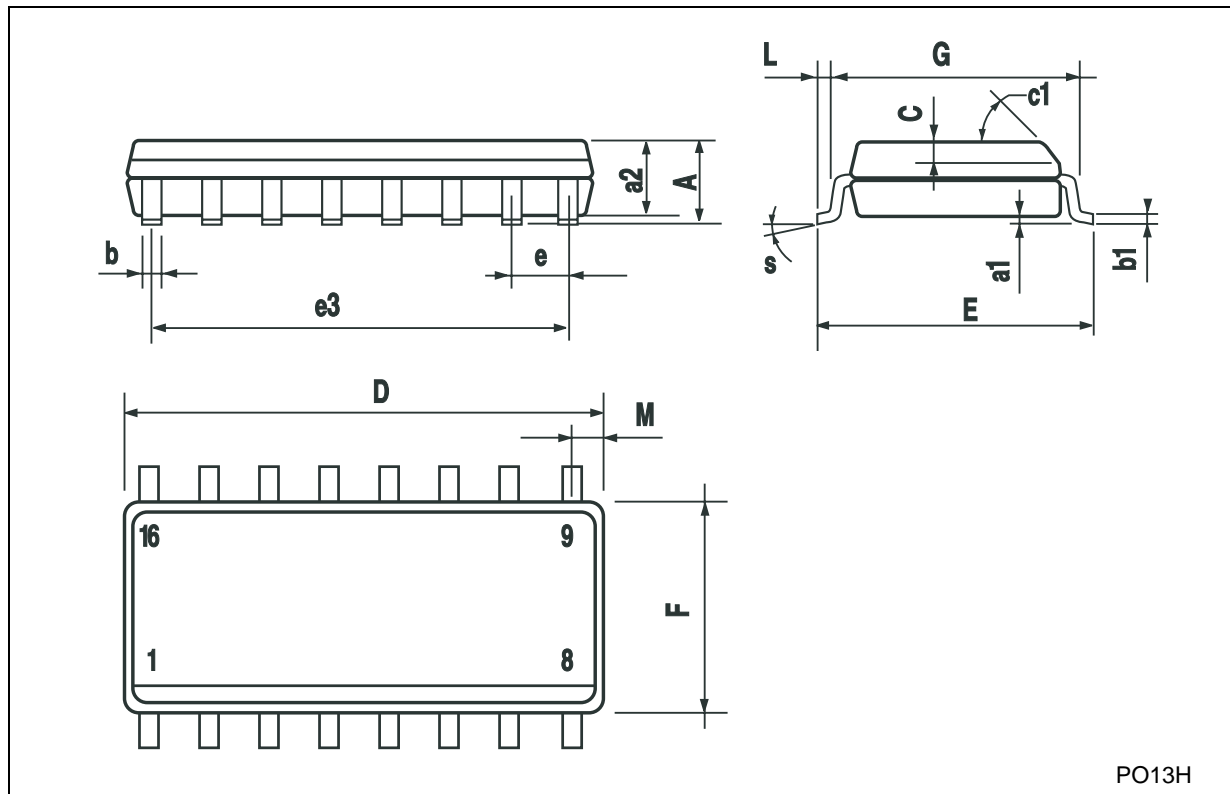

Figure 8 : Low to High Propagation Delay Time for Driver



SO-16 MECHANICAL DATA

DIM.	mm.			inch		
	MIN.	TYP.	MAX.	MIN.	TYP.	MAX.
A			1.75			0.068
a1	0.1		0.2	0.004		0.008
a2			1.65			0.064
b	0.35		0.46	0.013		0.018
b1	0.19		0.25	0.007		0.010
C		0.5			0.019	
c1	45° (typ.)					
D	9.8		10	0.385		0.393
E	5.8		6.2	0.228		0.244
e		1.27			0.050	
e3		8.89			0.350	
F	3.8		4.0	0.149		0.157
G	4.6		5.3	0.181		0.208
L	0.5		1.27	0.019		0.050
M			0.62			0.024
S	8			° (max.)		



PO13H

TSSOP16 MECHANICAL DATA

DIM.	mm.			inch		
	MIN.	TYP	MAX.	MIN.	TYP.	MAX.
A			1.2			0.047
A1	0.05		0.15	0.002	0.004	0.006
A2	0.8	1	1.05	0.031	0.039	0.041
b	0.19		0.30	0.007		0.012
c	0.09		0.20	0.004		0.0079
D	4.9	5	5.1	0.193	0.197	0.201
E	6.2	6.4	6.6	0.244	0.252	0.260
E1	4.3	4.4	4.48	0.169	0.173	0.176
e		0.65 BSC			0.0256 BSC	
K	0°		8°	0°		8°
L	0.45	0.60	0.75	0.018	0.024	0.030

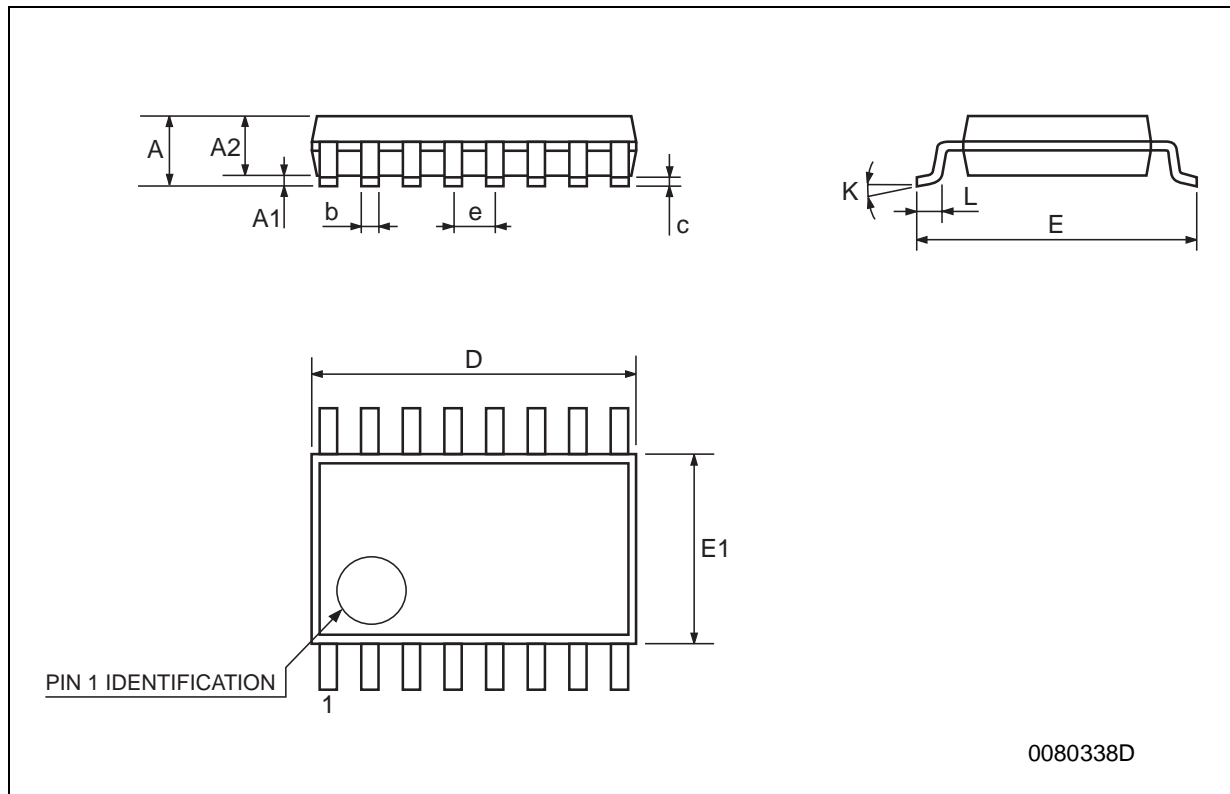

Tape & Reel SO-16 MECHANICAL DATA

DIM.	mm.			inch		
	MIN.	TYP	MAX.	MIN.	TYP.	MAX.
A			330			12.992
C	12.8		13.2	0.504		0.519
D	20.2			0.795		
N	60			2.362		
T			22.4			0.882
Ao	6.45		6.65	0.254		0.262
Bo	10.3		10.5	0.406		0.414
Ko	2.1		2.3	0.082		0.090
Po	3.9		4.1	0.153		0.161
P	7.9		8.1	0.311		0.319

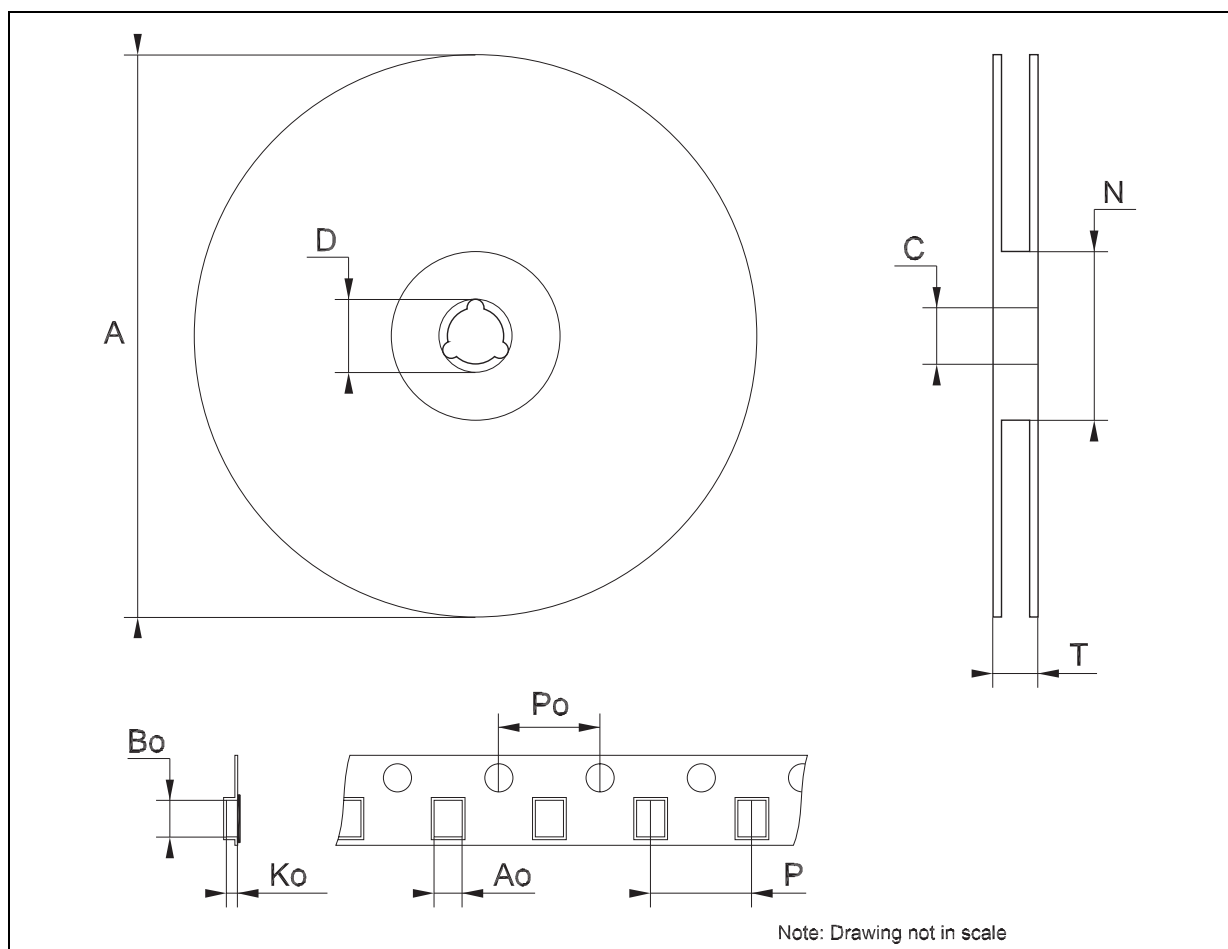

Tape & Reel TSSOP16 MECHANICAL DATA

DIM.	mm.			inch		
	MIN.	TYP	MAX.	MIN.	TYP.	MAX.
A			330			12.992
C	12.8		13.2	0.504		0.519
D	20.2			0.795		
N	60			2.362		
T			22.4			0.882
Ao	6.7		6.9	0.264		0.272
Bo	5.3		5.5	0.209		0.217
Ko	1.6		1.8	0.063		0.071
Po	3.9		4.1	0.153		0.161
P	7.9		8.1	0.311		0.319

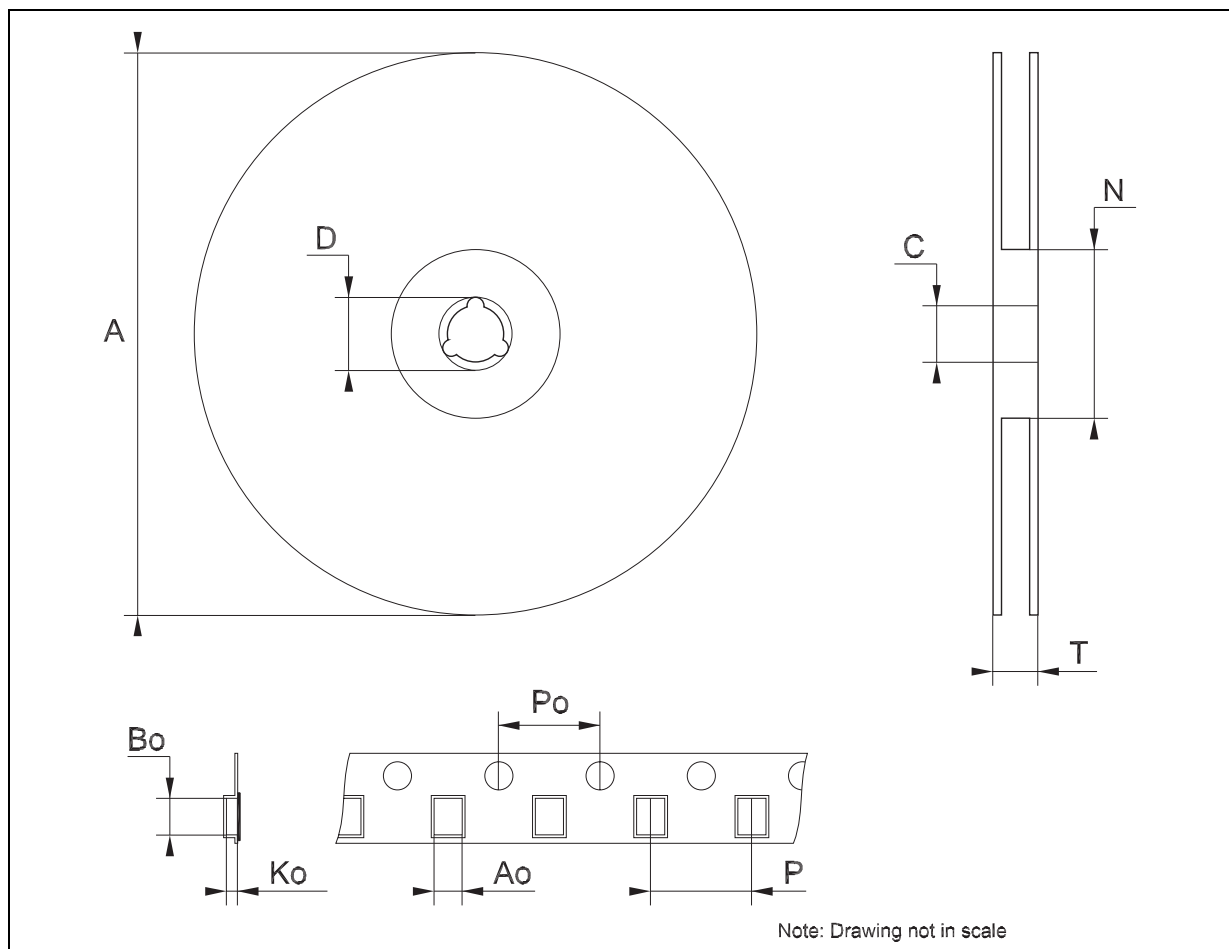

Information furnished is believed to be accurate and reliable. However, STMicroelectronics assumes no responsibility for the consequences of use of such information nor for any infringement of patents or other rights of third parties which may result from its use. No license is granted by implication or otherwise under any patent or patent rights of STMicroelectronics. Specifications mentioned in this publication are subject to change without notice. This publication supersedes and replaces all information previously supplied. STMicroelectronics products are not authorized for use as critical components in life support devices or systems without express written approval of STMicroelectronics.

© The ST logo is a registered trademark of STMicroelectronics

© 2003 STMicroelectronics - Printed in Italy - All Rights Reserved
STMicroelectronics GROUP OF COMPANIES

Australia - Brazil - Canada - China - Finland - France - Germany - Hong Kong - India - Israel - Italy - Japan - Malaysia - Malta - Morocco
Singapore - Spain - Sweden - Switzerland - United Kingdom - United States.

© <http://www.st.com>

