

SMD Zener Diode

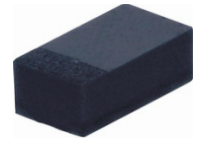

SMD Diodes Specialist

CZRFR52C2 Thru CZRFR52C39 (RoHS Device)



Voltage 2 to 39 Volts
Power 200 mWatts

Features

- 200mW Power Dissipation.
- High Voltages from 2 ~ 39 V.
- Designed for mounting on small surface.
- Extremely thin/leadless package.
- Pb free product.

Mechanical data

- Case: 1005(2512)Standard package
Molded plastic.
- Terminals: Gold plated, solderable per
MIL-STD-750,method 2026.
- Polarity: Indicated by cathode band.
- Weight: 0.006 gram(approx.).

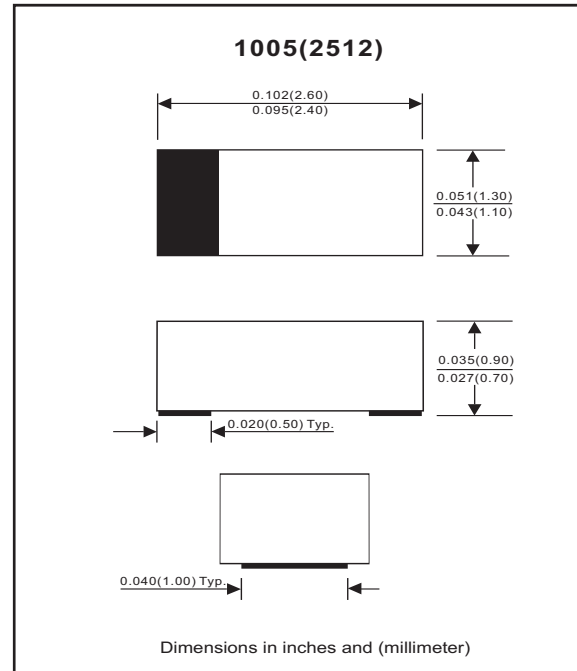

Maximum Rating AND Electrical Characteristics

Parameter	Symbol	Value	Unit
Maximum Forward Voltage Drop at $I_F = 10 \text{ mA}$	V_F	0.9	V
Maximum Power Dissipation at 25°C	P_D	200	mW
Forward current , surge peak 8.3 ms single half sine-wave superimposed on rate load(JEDEC method)	I_{FSM}	2.0	A
Peak ESD voltage capability (IEC 61000-4-2)	V_{PV}	8	kV
Operating Junction and Storage Temperature Range	T_J	-55 to +125	$^\circ\text{C}$

Electrical Characteristics (TA=25°C)

Part Number	Marking Code	Zener Voltage			Operating resistance		Rising operating Resistance		Reverse current	
		V _Z (V)			ZZT(Ohm)		ZZK(Ohm)		IR(μA)	
		Min	Max	I _Z (mA)	Max	I _Z (mA)	Max	I _Z (mA)	Max	V _R (V)
CZRFR52C2	Z0	1.90	2.10	5	100	5	600	1	100	1
CZRFR52C2V2	Z1	2.09	2.31	5	100	5	600	1	100	1
CZRFR52C2V4	Z2	2.28	2.52	5	85	5	600	1	100	1
CZRFR52C2V7	Z3	2.57	2.84	5	83	5	500	1	75	1
CZRFR52C3	Z4	2.85	3.15	5	95	5	500	1	50	1
CZRFR52C3V3	Z5	3.14	3.47	5	95	5	500	1	25	1
CZRFR52C3V6	Z6	3.42	3.78	5	95	5	500	1	15	1
CZRFR52C3V9	Z7	3.71	4.10	5	95	5	500	1	10	1
CZRFR52C4V3	Z8	4.09	4.52	5	95	5	500	1	5	1
CZRFR52C4V7	Z9	4.47	4.94	5	78	5	500	1	5	2
CZRFR52C5V1	ZA	4.85	5.36	5	60	5	480	1	0.1	0.8
CZRFR52C5V6	ZB	5.32	5.88	5	40	5	400	1	0.1	1
CZRFR52C6V2	ZC	5.89	6.51	5	10	5	200	1	0.1	2
CZRFR52C6V8	ZE	6.46	7.14	5	8	5	150	1	0.1	3
CZRFR52C7V5	ZF	7.13	7.88	5	7	5	50	1	0.1	5
CZRFR52C8V2	ZG	7.79	8.61	5	7	5	50	1	0.1	6
CZRFR52C9V1	ZH	8.65	9.56	5	10	5	50	1	0.1	7
CZRFR52C10	ZJ	9.50	10.50	5	15	5	70	1	0.1	7.5
CZRFR52C11	ZK	10.45	11.55	5	20	5	70	1	0.1	8.5
CZRFR52C12	ZM	11.40	12.60	5	20	5	90	1	0.1	9
CZRFR52C13	ZN	12.35	13.65	5	25	5	110	1	0.1	10
CZRFR52C15	ZP	14.25	15.75	5	30	5	110	1	0.1	11
CZRFR52C16	ZQ	15.20	16.80	5	40	5	170	1	0.1	12
CZRFR52C18	ZR	17.10	18.90	5	50	5	170	1	0.1	14
CZRFR52C20	ZS	19.00	21.00	5	50	5	220	1	0.1	15
CZRFR52C22	ZT	20.90	23.10	5	55	5	220	1	0.1	17
CZRFR52C24	ZU	22.80	25.20	5	80	5	220	1	0.1	18
CZRFR52C27	ZV	25.65	28.35	5	80	5	250	1	0.1	20
CZRFR52C30	ZW	28.50	31.50	5	80	5	250	1	0.1	23
CZRFR52C33	ZX	31.35	34.65	5	80	5	250	1	0.1	25
CZRFR52C36	ZY	34.20	37.80	5	90	5	250	1	0.1	27
CZRFR52C39	ZZ	37.05	40.95	5	90	5	300	1	0.1	29

RATING AND CHARACTERISTIC CURVES (CZRFR52C2 Thru CZRFR52C39)

Fig.1 TEMPERATURE COEFFICIENTS

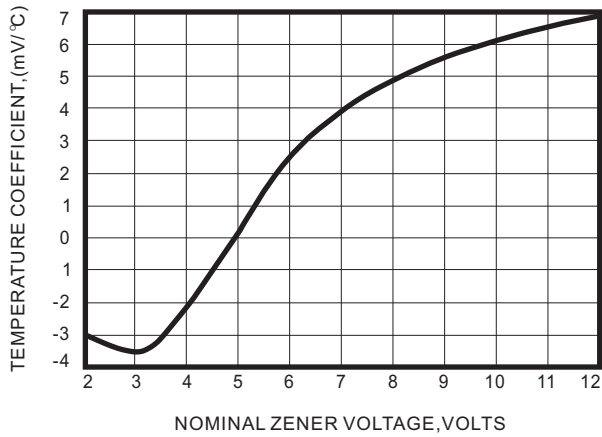

Fig.2 TEMPERATURE COEFFICIENTS

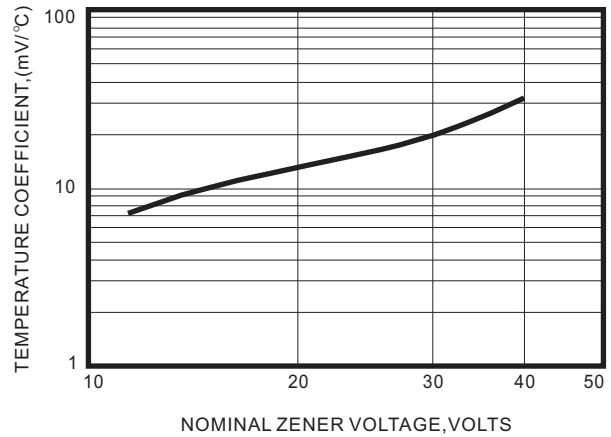

Fig.3 EFFECT OF ZENER VOLTAGE ON ZENER IMPEDANCE

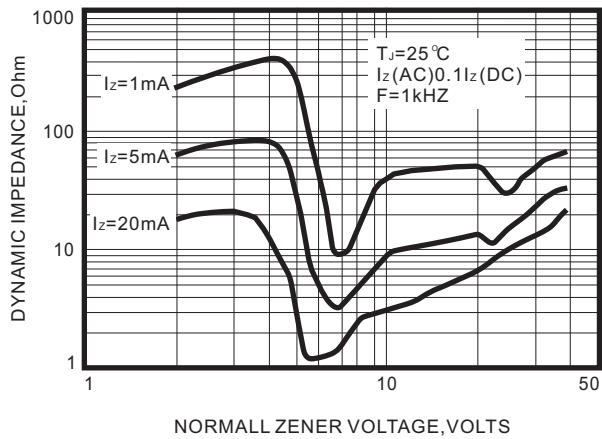

Fig.4 TYPICAL FORWARD VOLTAGE

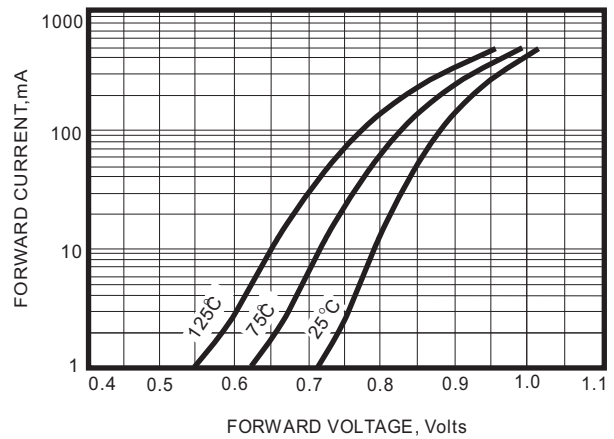

Fig.5 TYPICAL LEAKAGE CURRENT

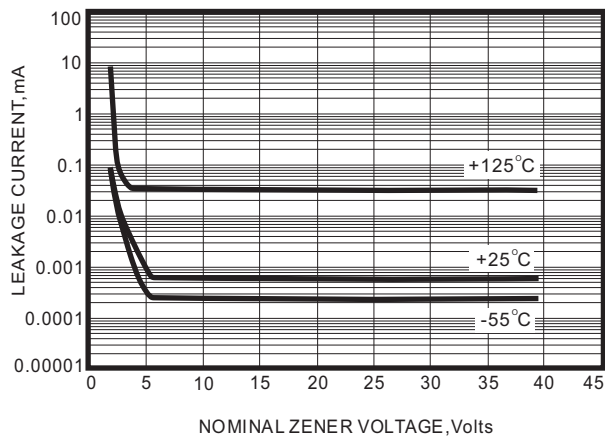
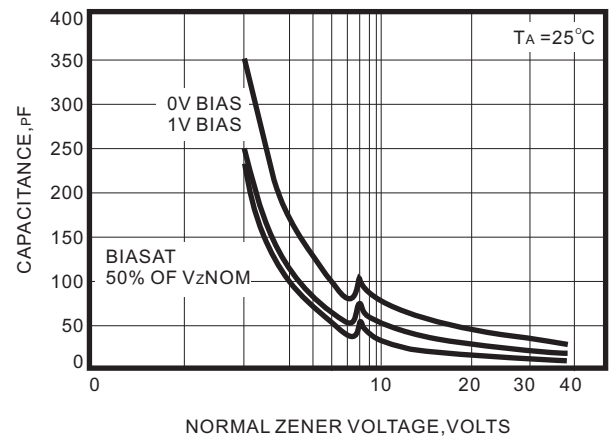

Fig.6 TYPICAL CAPACITANCE



RATING AND CHARACTERISTIC CURVES (CZRFR52C2 Thru CZRFR52C39)

Fig.7 ZENER VOLTAGE VERSUS ZENER CURRENT

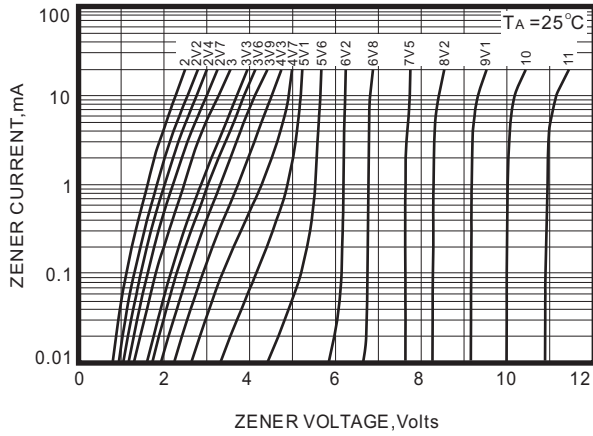

Fig.8 ZENER VOLTAGE VERSUS ZENER CURRENT

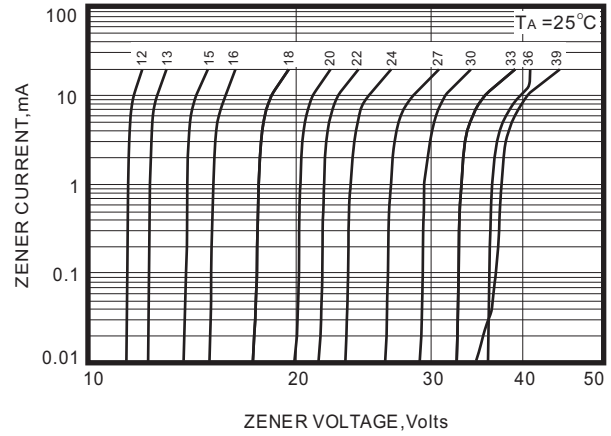
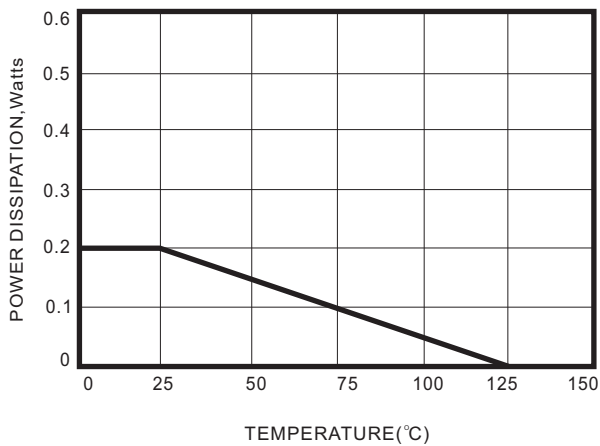
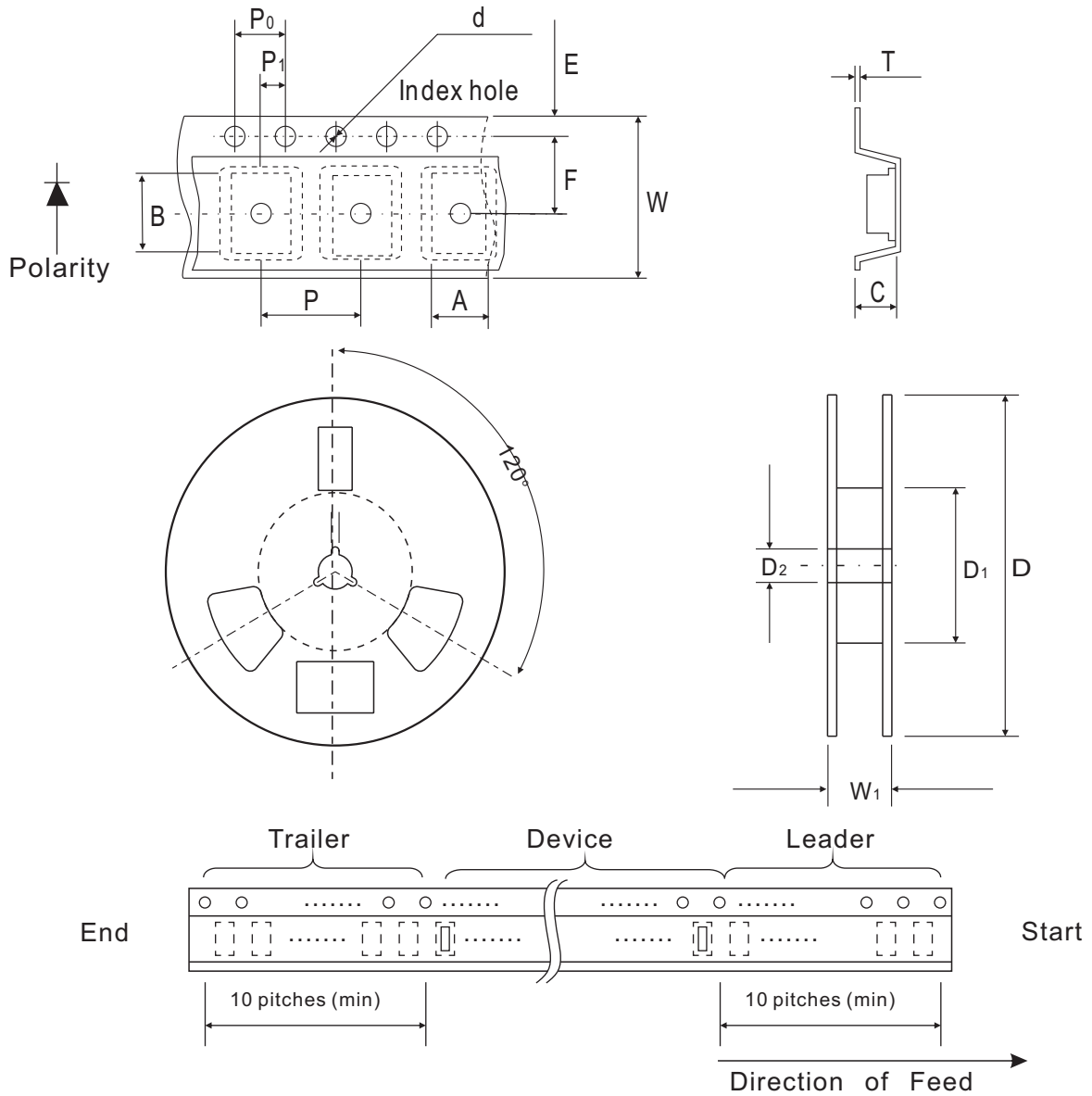

Fig.9 STEADY STATE POWER DERATING



Reel Taping Specification



FR/1005	SYMBOL	A	B	C	d	D	D ₁	D ₂
	(mm)	1.55 ± 0.10	2.65 ± 0.10	1.05 ± 0.10	1.55 ± 0.05	178 ± 1	60.0 MIN.	13.0 ± 0.20
	(inch)	0.061 ± 0.004	0.104 ± 0.004	0.041 ± 0.004	0.061 ± 0.002	7.008 ± 0.04	2.362 MIN.	0.512 ± 0.008

FR/1005	SYMBOL	E	F	P	P ₀	P ₁	T	W	W ₁
	(mm)	1.75 ± 0.10	3.50 ± 0.05	4.00 ± 0.10	4.00 ± 0.10	2.00 ± 0.05	0.23 ± 0.05	8.00 ± 0.20	13.5 MAX.
	(inch)	0.069 ± 0.004	0.138 ± 0.002	0.157 ± 0.004	0.157 ± 0.004	0.079 ± 0.004	0.009 ± 0.002	0.315 ± 0.008	0.531 MAX.

Suggested PAD Layout

SIZE	FR/1005	
	(mm)	(inch)
A	2.00	0.079
B	0.70	0.028
C	1.30	0.051
D	2.70	0.106
E	1.30	0.051

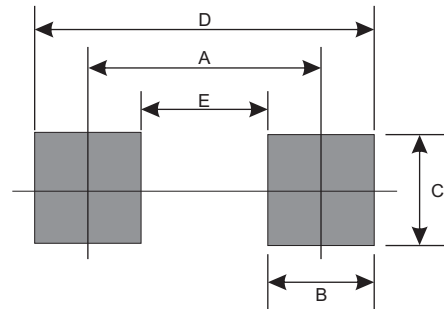

Standard Package

Case Type	Qty per Reel	Reel Size
	(Pcs)	(inch)
FR/1005	4000	7