

System Power Supply LSI Series for Use in Automotive Electronics

DMOS System Power Supply ICs with low current consumption



BD4912/BD4912-V4

●Description

The BD4912/BD4912-V4 provides multiple supply voltage outputs for use in car audio and satellite navigation systems with CD player, radio, antenna, lighting, and other components. In addition to overcurrent, overvoltage, and thermal shutdown circuits, it incorporates circuitry for reacting to sudden BATTERY power failures and is ideal for car audio and satellite navigation systems. With its 110 μ A (max.) standby current, the BD4912/BD4912-V4 delivers low current consumption when the BATTERY is off.

●Features

- 1) Built-in power supplies for car audio and satellite navigation systems
 - 5.0 V microcontroller power supply
 - 8.12 V audio power supply
 - 7.9 V radio power supply
 - 10.3 V lighting power supply
 - 1 V_{DD}-linked high side switch
 - 2 V_{CC}-linked high side switches
- 2) Compatible with 0.1 μ F output load ceramic capacitors. (Note: Select the adequate capacitance values for each particular application)
- 3) The ability to operate V_{DD} using the charge stored in a backup capacitor, prevents the IC from malfunctioning in the event of a sudden BATTERY power failure.
- 4) Output pins use low-dropout P-channel POWER MOS FETs
- 5) Built-in overcurrent protection circuits
- 6) Built-in overvoltage protection circuits
- 7) Built-in thermal shutdown circuit
- 8) A 12-pin power package gives the IC large power dissipation capabilities and is ideal for space-saving designs.

● Applications

Car audio and satellite navigation systems

● **Absolute maximum ratings** (Ta = 25°C)

Parameter	Symbol	Limits	Unit
Supply Voltage 1	Vcc1	36	V
Supply Voltage 2	Vcc2	36	V
SEL1 Supply Voltage	SEL1	12	V
SEL2 Supply Voltage	SEL2	12	V
Power Dissipation	Pd	3400	mW
Operating Temperature Range	Topr	-40 to +85	°C
Storage Temperature Range	Tstg	-55 to +150	°C
Maximum Junction Temperature	Tjmax	150	°C
Peak Supply Voltage 1	Vcc1 PEAK	50 (*1)	V
Peak Supply Voltage 2	Vcc2 PEAK	50 (*1)	V

*1 tr ≥ 1 ms; Bias voltage is applied for less than 200 ms.

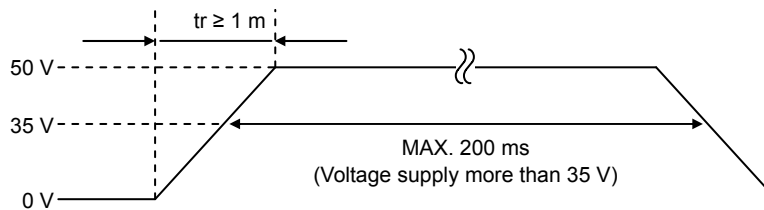

Fig.1 Peak Supply Voltage Waveform

● **Recommended operating ranges** (Ta = 25°C)

Parameter	Limits	Unit	Comment
Recommended Supply Voltage Range1	10 to 18	V	Except VDD and ILM output
Recommended Supply Voltage Range 2	11.5 to 18	V	ILM output
Recommended Supply Voltage Range 3	6.3 to 18	V	VDD output

● **Electrical characteristics** (Unless otherwise specified, Ta = 25°C; Vcc1 = Vcc2 = 14.4 V)

Parameter	Symbol	Limits			Unit	Condition
		Min.	Typ.	Max.		
Standby Circuit Current	Ist	—	—	110	μA	
Output Voltage (VDD) 1	Vo1	4.80	5.00	5.20	V	Io = 300 mA, Vcc2 = 10 V to 18 V
Dropout Voltage	ΔVo1	—	0.8	1.1	V	Io = 300 mA, Vcc2-Vo1
Peak Output Current	Io1	400	—	—	mA	Vo1 ≥ 4.8 V
Ripple Rejection Ratio	R.R1	50	55	—	dB	f = 100 Hz, VRR = -10 dBV, Io = 300 mA
Low Vcc Output Voltage	Vo1'	4.8	—	—	V	Vcc2 = 5 V, Io = 10 mA
Output Voltage (AUDIO) 2	Vo2	7.8	8.12	8.3	V	Io2 = 200 mA, Vcc1 = 10 V to 18 V
Dropout Voltage	ΔVo2	—	0.4	0.7	V	Io2 = 200 mA, Vcc1-Vo2
Peak Output Current	Io2	200	—	—	mA	Vo2 ≥ 7.8 V
Ripple Rejection Ratio	R.R2	45	55	—	dB	f = 100 Hz, VRR = -10 dBV, Io = 200 mA

- ⊙ This product is not designed for protection against radioactive rays.
- ⊙ Use Peak Output Current less than Limits Min. values.

● **Electrical characteristics** (Unless otherwise specified, Ta = 25°C; Vcc1= Vcc2 = 14.4 V)

Parameter	Symbol	Limits			Unit	Condition
		Min.	Typ.	Max.		
(SEL1 > 3.5 V)						
Dropout Voltage (P.CON) 3	ΔV_{o3}	—	0.4	0.7	V	$I_{o3} = 350 \text{ mA}$, $V_{cc1} - V_{o3}$
Peak Output Current	I_{o3}	350	—	—	mA	$V_{o3} \geq 13.7 \text{ V}$
(SEL1 > 7.0 V)						
Dropout Voltage (P.ANT) 4	ΔV_{o4}	—	0.4	0.7	V	$I_{o4} = 300 \text{ mA}$, $V_{cc1} - V_{o4}$
Peak Output Current	I_{o4}	300	—	—	mA	$V_{o4} \geq 13.7 \text{ V}$
(SEL2 > 3.5 V)						
Output voltage (AM) 5	V_{o5}	7.5	7.9	8.3	V	$I_{o5} = 25 \text{ mA}$, $V_{cc1} = 10 \text{ V to } 18 \text{ V}$
Dropout Voltage	ΔV_{o5}	—	0.4	0.7	V	$I_{o5} = 25 \text{ mA}$, $V_{cc1} - V_{o5}$
Peak Output Current	I_{o5}	25	—	—	mA	$V_{o5} \geq 7.5 \text{ V}$
Ripple Rejection Ratio	R.R5	45	55	—	dB	$f = 100 \text{ Hz}$, $VRR = -10 \text{ dBV}$, $I_{o} = 25 \text{ mA}$
(SEL2 > 2.0 V)						
Dropout Voltage (SW5V)	ΔV_{o6}	—	0.15	0.3	V	$I_{o6} = 30 \text{ mA}$, $V_{DD} - V_{o6}$
Peak Output Current	I_{o6}	30	—	—	mA	$V_{o6} \geq V_{DD} - 0.2 \text{ V}$
(SEL1 > 1.5 V)						
Output voltage (ILM) 7	V_{o7}	9.9	10.3	10.7	V	$I_{o7} = 200 \text{ mA}$, $V_{cc1} = 12 \text{ V to } 18 \text{ V}$
Dropout Voltage	ΔV_{o7}	—	0.5	0.8	V	$I_{o7} = 200 \text{ mA}$, $V_{cc1} - V_{o7}$
Peak Output Current	I_{o7}	200	—	—	mA	$V_{o7} \geq 9.9 \text{ V}$
Ripple Rejection Ratio	R.R7	40	50	—	dB	$f = 100 \text{ Hz}$, $VRR = -10 \text{ dBV}$, $I_{o} = 200 \text{ mA}$
Input (SEL1)						
Standby Level	V_{th1-1}	—	—	1.0	V	
ILM ON	V_{th1-2}	1.5	—	3.0	V	
ILM, P-CON ON	V_{th1-3}	3.5	—	5.0	V	
ILM, P-CON, P-ANT ON	V_{th1-4}	7.0	—	12.0	V	
SEL1 Input Impedance	R_{in1}	100	—	—	k Ω	
Input (SEL2)						
Standby Level	V_{th2-1}	—	—	1.0	V	
AUDIO, SW5V ON	V_{th2-2}	2.0	—	3.0	V	
AUDIO, SW5V, AM ON	V_{th2-3}	3.5	—	V_{DD}	V	
SEL2 Input Impedance	R_{in2}	100	—	—	k Ω	
Overvoltage Protection Threshold	V_{ovp}	27	30	33	V	

⊙ This product is not designed for protection against radioactive rays.

⊙ Use Peak Output Current less than Limits Min. values.

● Reference data (Unless otherwise specified, $V_{CC1} = V_{CC2} = 14.4\text{ V}$)

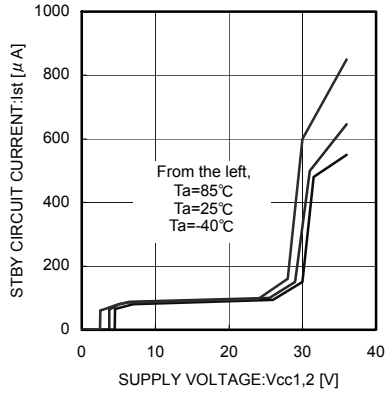

Fig.2 Standby Circuit Current

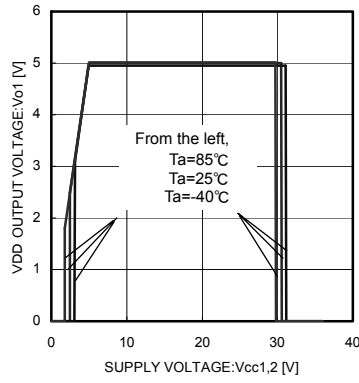

Fig.3 VDD Line Regulation ($I_o = \text{No load}$)

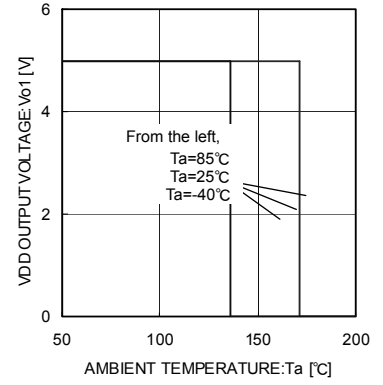

Fig.4 VDD Load Regulation

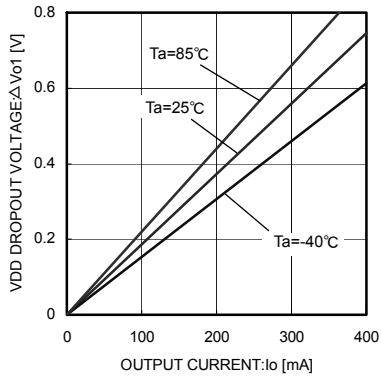

Fig.5 VDD Dropout Voltage ($V_{CC1} = V_{CC2} = 4.8\text{ V}$)

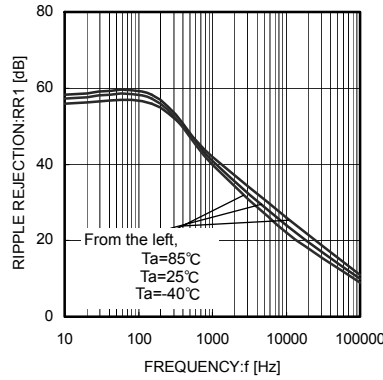

Fig.6 VDD Ripple Rejection Ratio ($I_o = 300\text{ mA}$)

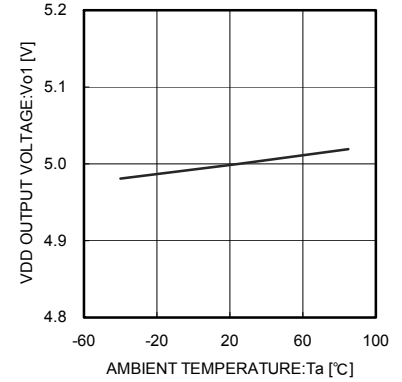

Fig.7 VDD Output Voltage vs Temperature

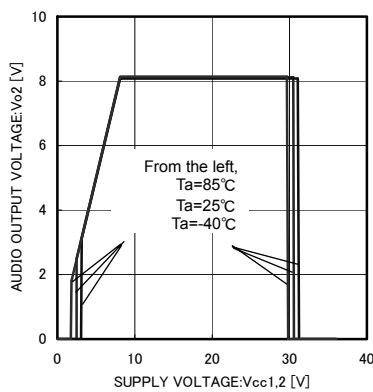

Fig.8 AUDIO Line Regulation ($I_o = \text{No load}$)

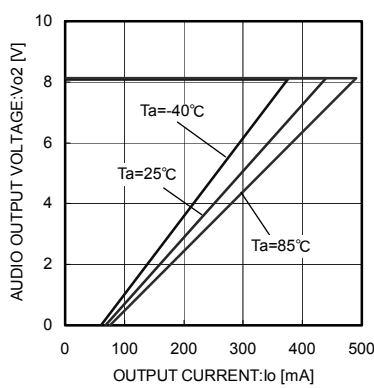

Fig.9 AUDIO Load Regulation

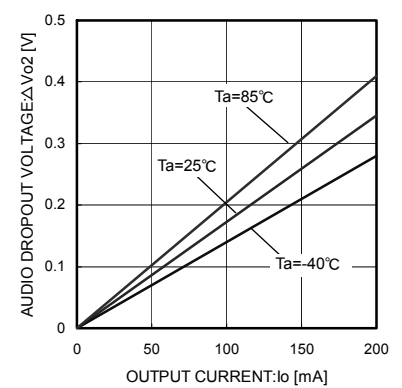

Fig.10 AUDIO Dropout Voltage ($V_{CC1} = V_{CC2} = 7.8\text{ V}$)

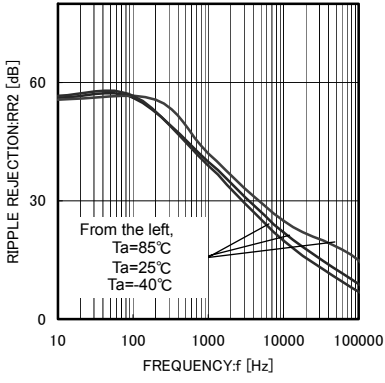

Fig.11 AUDIO Ripple Rejection Ratio (Io = 200 mA)

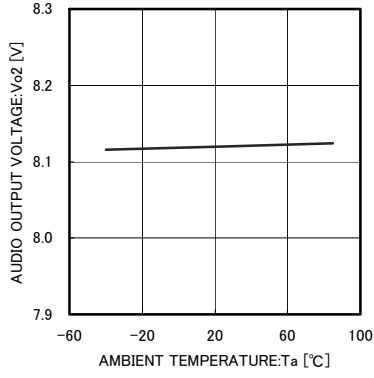

Fig.12 AUDIO Output Voltage vs Temperature

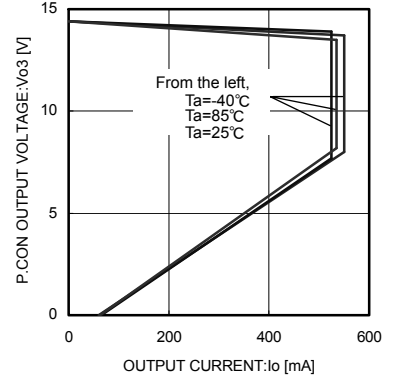

Fig.13 P.CON Load Regulation

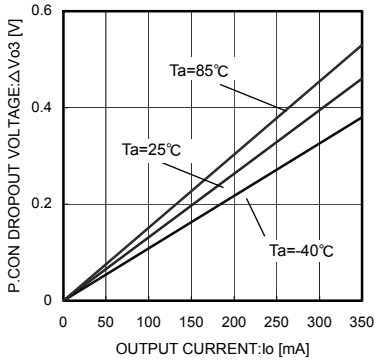

Fig.14 P.CON Dropout Voltage

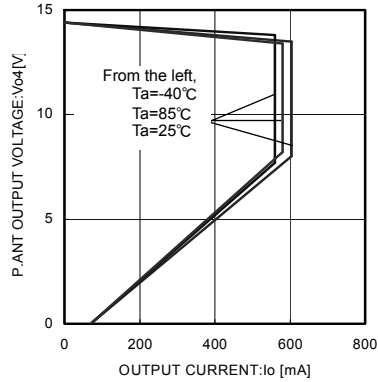

Fig.15 P.ANT Load Regulation

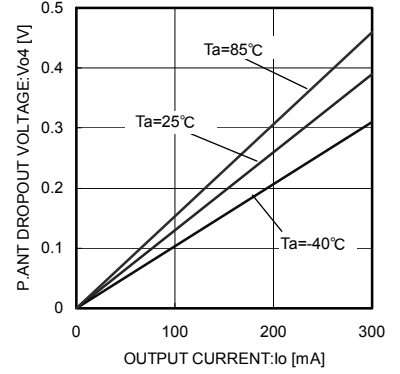

Fig.16 P.ANT Dropout Voltage

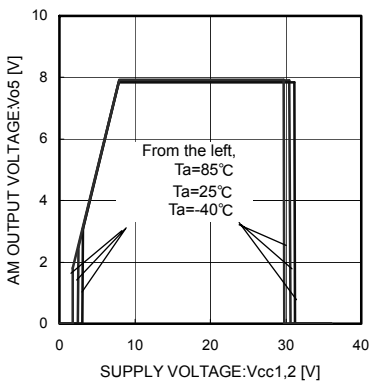

Fig.17 AM Line Regulation (Io = No load)

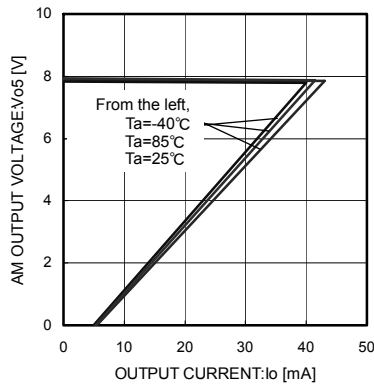

Fig.18 AM Load Regulation

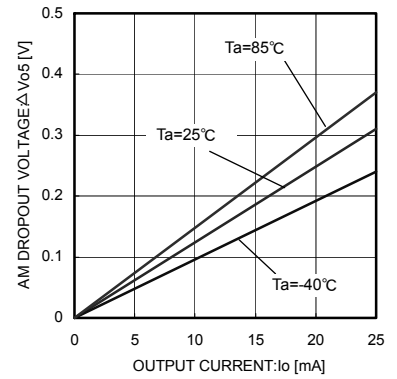

Fig.19 AM Dropout Voltage (Vcc1 = Vcc2 = 7.5 V)

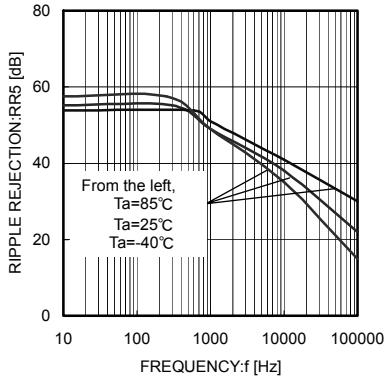

Fig.20 AM Ripple Rejection Ratio
($I_o = 25 \text{ mA}$)

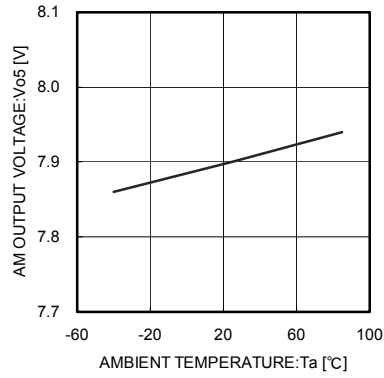

Fig.21 AM Output Voltage
vs Temperature

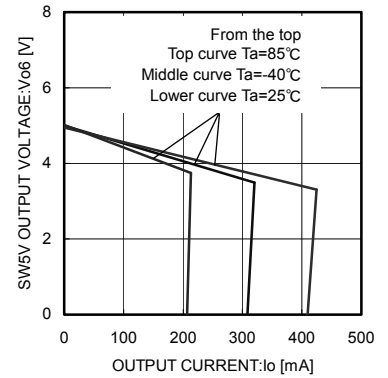

Fig.22 SW5V Load
Regulation

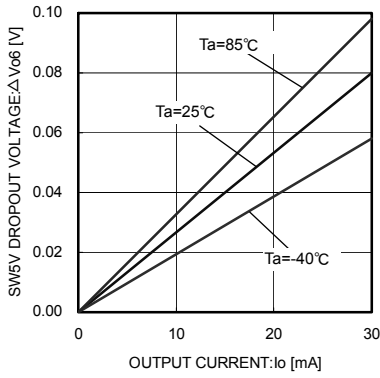

Fig.23 SW5V Dropout Voltage
($V_{cc1} = V_{cc2} = 10 \text{ V}$)

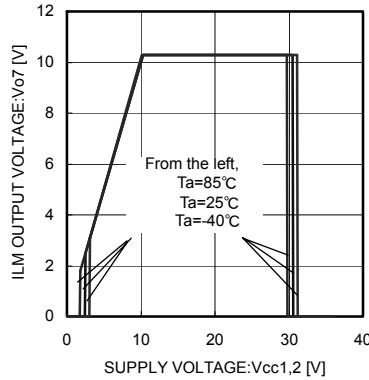

Fig.24 ILM Line Regulation
($I_o = \text{No load}$)

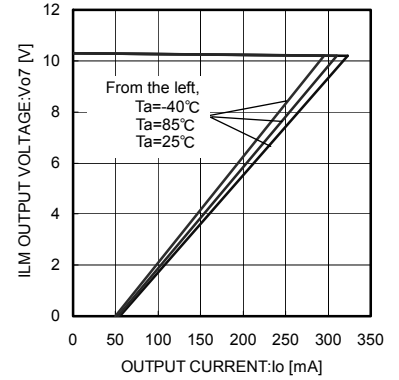

Fig.25 ILM Load Regulation

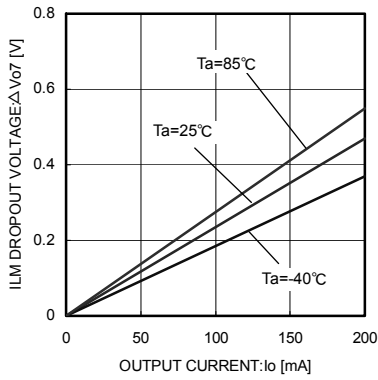

Fig.26 ILM Dropout Voltage
($V_{cc1} = V_{cc2} = 9.9 \text{ V}$)

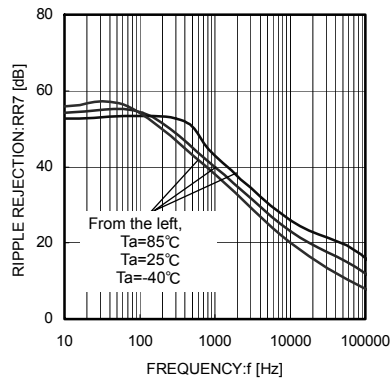

Fig.27 ILM Ripple Rejection Ratio
($I_o = 200 \text{ mA}$)

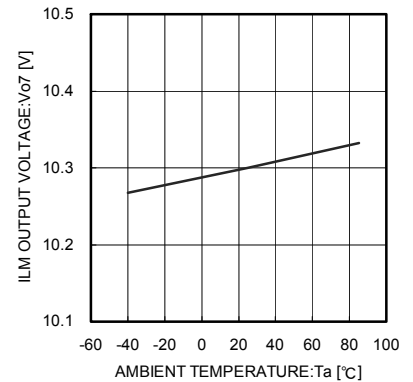

Fig.28 ILM Output Voltage
vs Temperature

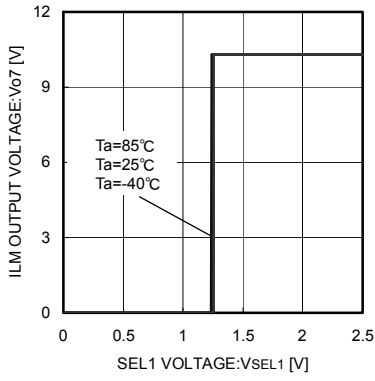

Fig.29 ILM Input Threshold Voltage

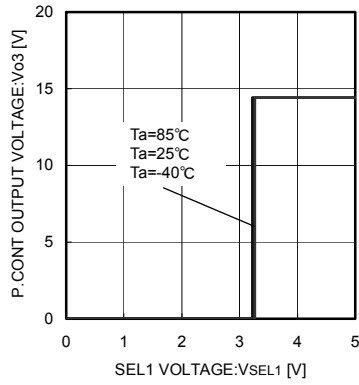

Fig.30 P.CON Input Threshold Voltage

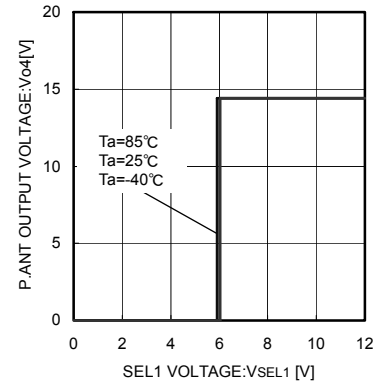

Fig.31 P.ANT Input Threshold Voltage

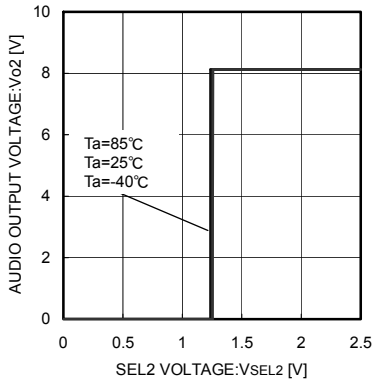

Fig.32 AUDIO Input Threshold Voltage

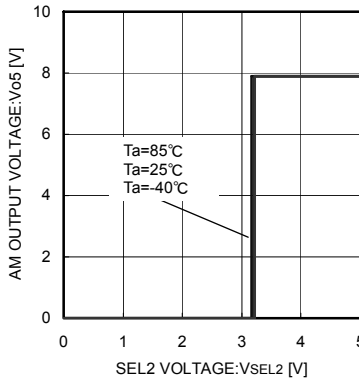

Fig.33 AM Input Threshold Voltage

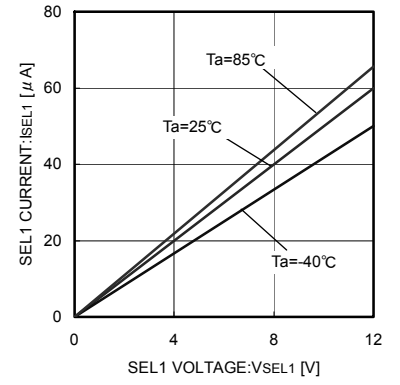

Fig.34 SEL1 Input Current

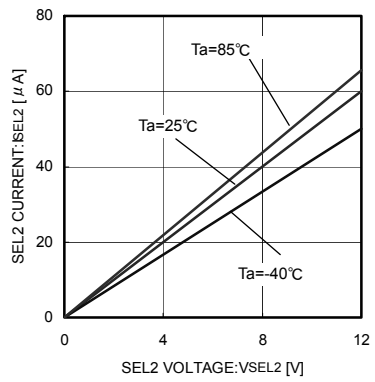

Fig.35 SEL2 Input Current

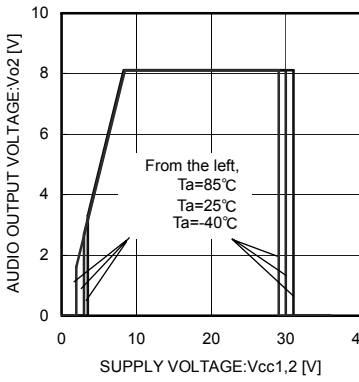

Fig.36 Overvoltage Operation

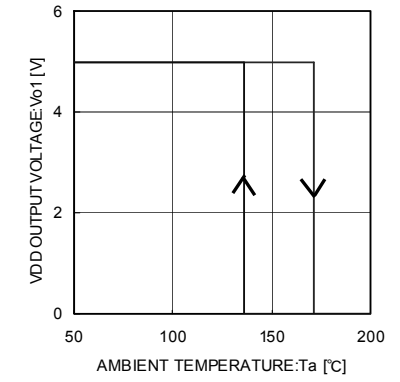

Fig.37 Thermal Shutdown Operation

●Block diagram

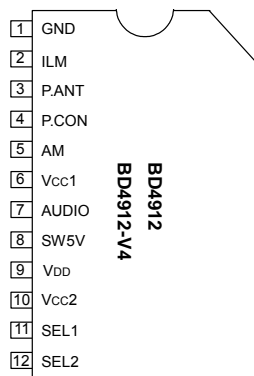

Fig.38 Pin Assignment Diagram

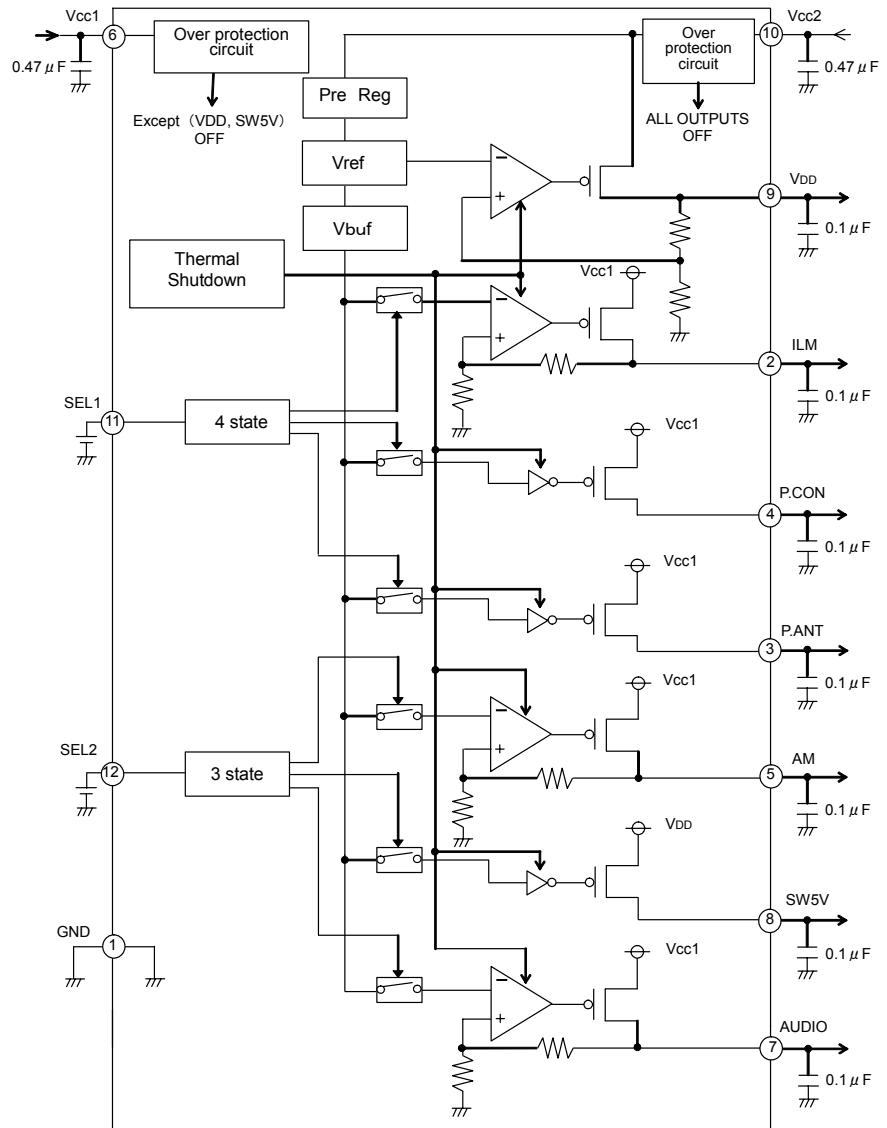
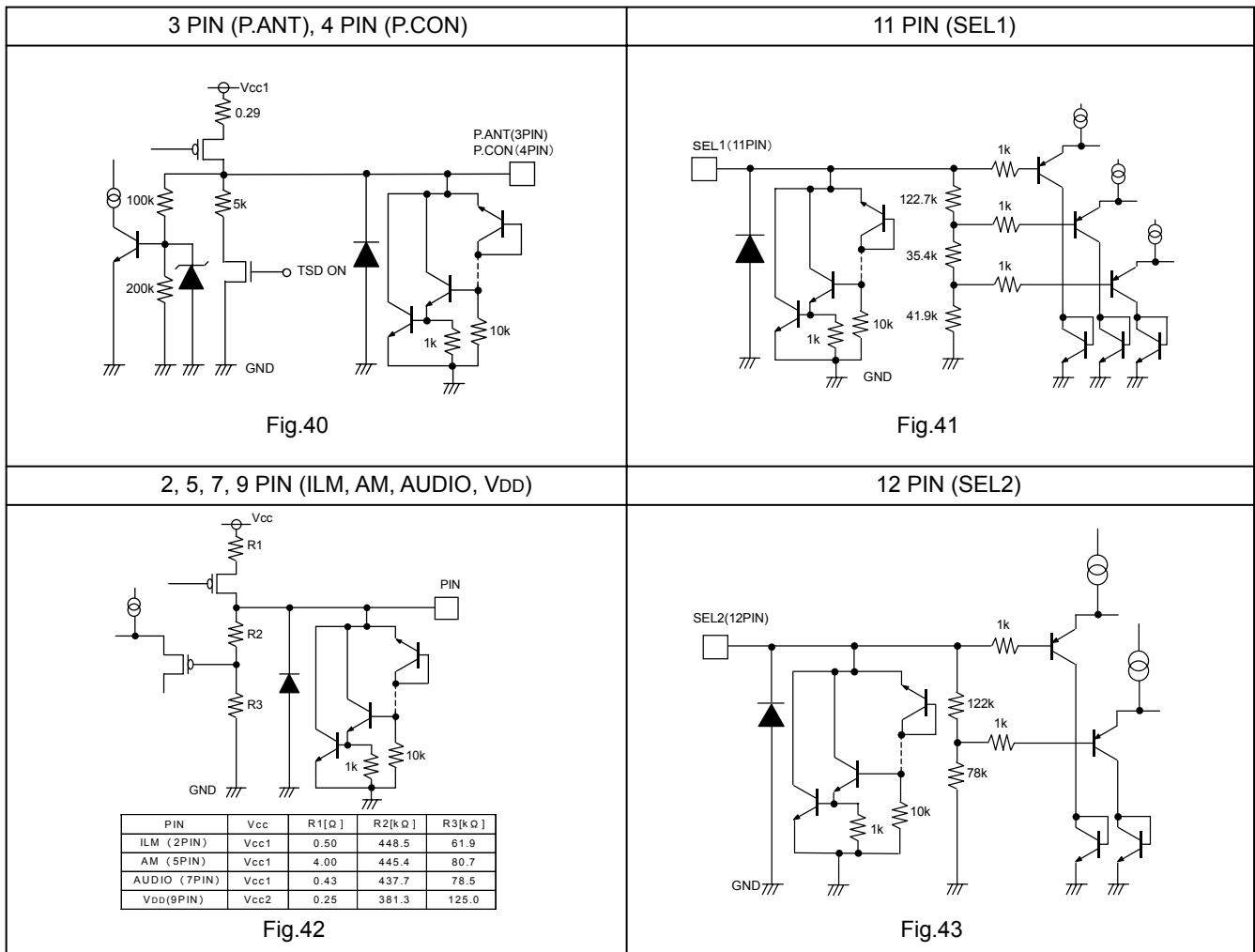

Fig.39 Block Diagram

●Pin descriptions

1	GND	This pin is connected to the IC's substrate.
2	ILM	This pin serves as the lighting power supply (10.3 V; Peak output current: 200 mA).
3	P.ANT	This pin outputs a voltage that is approximately 0.4 V (TYP) lower than the Vcc1 pin voltage, and the peak output current is 300 mA.
4	P.CON	This pin outputs a voltage that is approximately 0.4 V (TYP) lower than the Vcc1 pin voltage, and the peak output current is 350 mA.
5	AM	This pin serves as the AM receiver power supply (7.9 V; Peak output current: 25 mA).
6	Vcc1	This pin is connected to the car's backup and ACC power supplies.
7	AUDIO	This pin serves as the common system power supply for volume and sound control (8.12 V, Peak output current: 200 mA), as well as the power supply for variable capacitance diodes and other components used for electronic tuning and cassette player features, such as the equalizer.
8	SW5V	This pin serves as the microcontroller power supply (5.0 V; Peak output current: 30 mA).
9	VDD	This pin serves as the microcontroller power supply (5.0 V; Peak output current: 400 mA).
10	Vcc2	This pin serves as the VDD power supply pin.
11	SEL1	ILM, P.CON, and P.ANT output can be switched on or off by applying a 2.25 V, 4.25 V, or 9.5 V signal to this pin.
12	SEL2	AUDIO, SW5V, and AM output can be switched on or off by applying a 2.5 V or 4.25 V signal to this pin.

● I/O Equivalent circuit diagrams



● Timing Chart

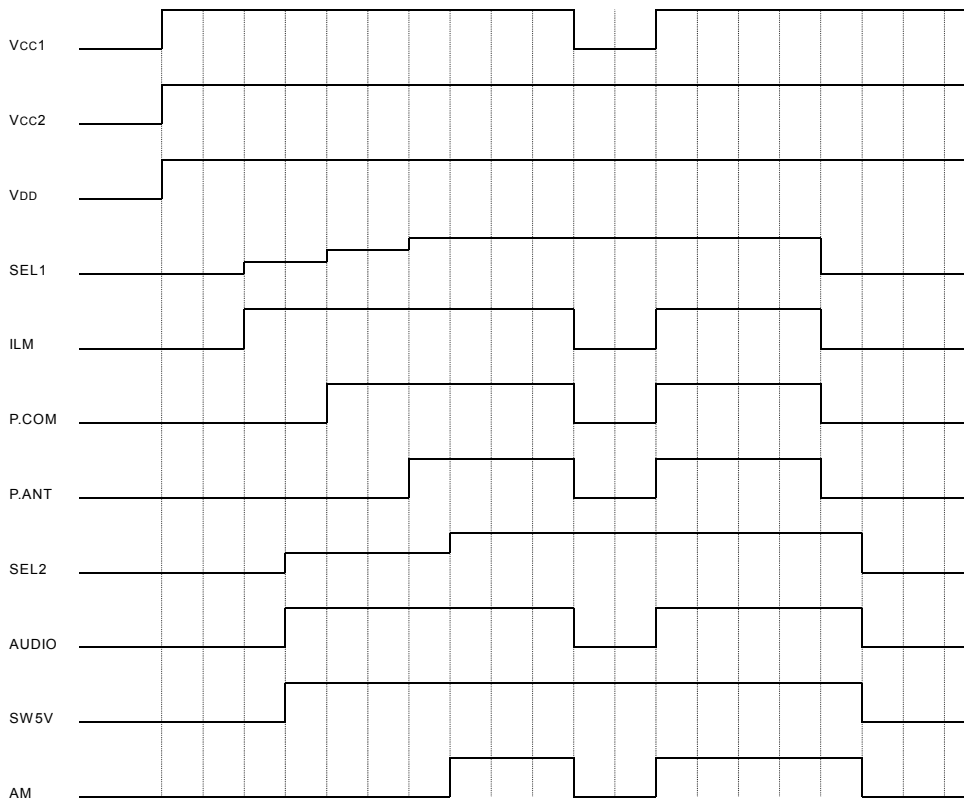
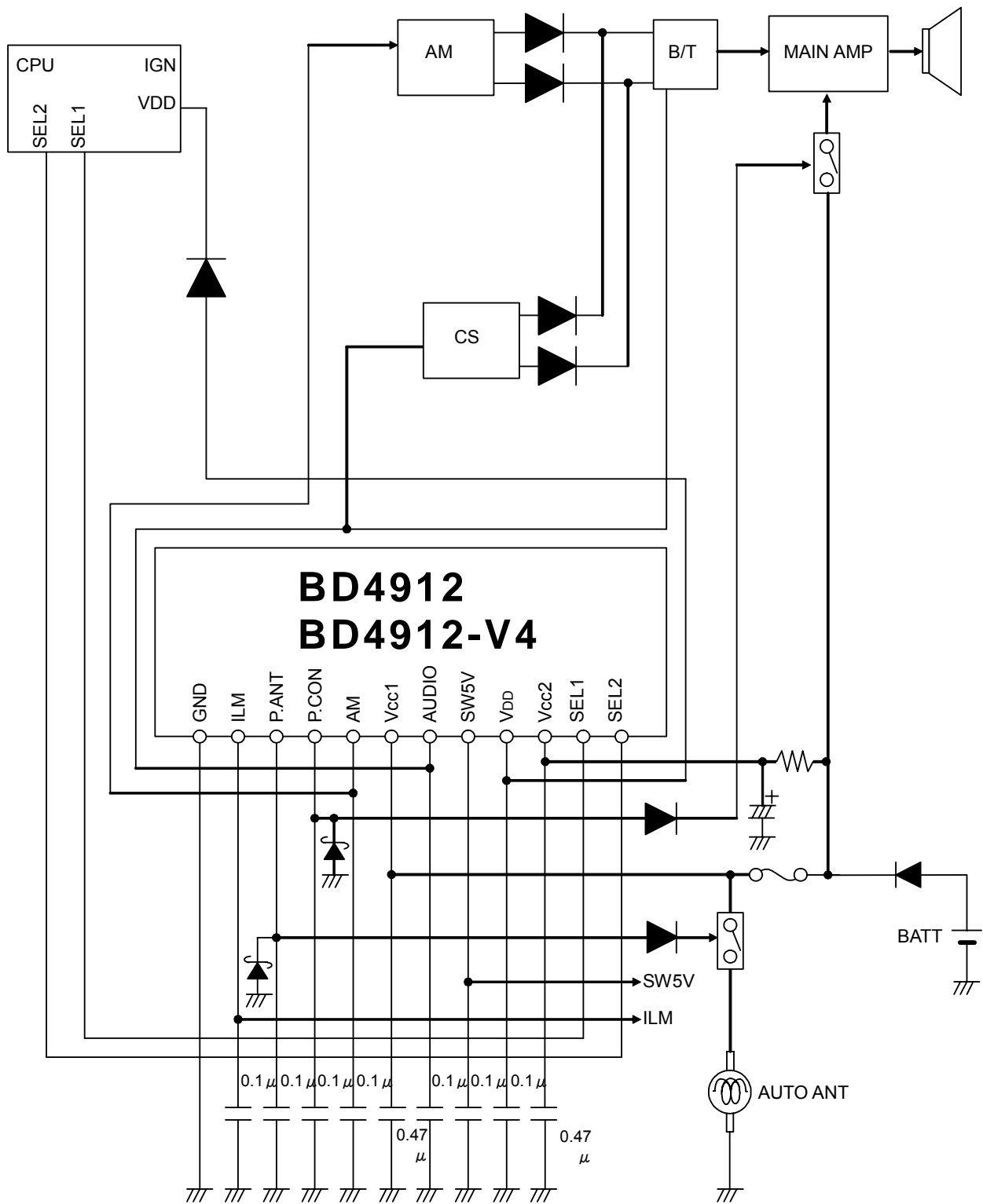

Fig.44 Timing Chart

●Application circuit



(Unit R: Ω , C: F)

Fig.45 Application Circuits Example

● Thermal design

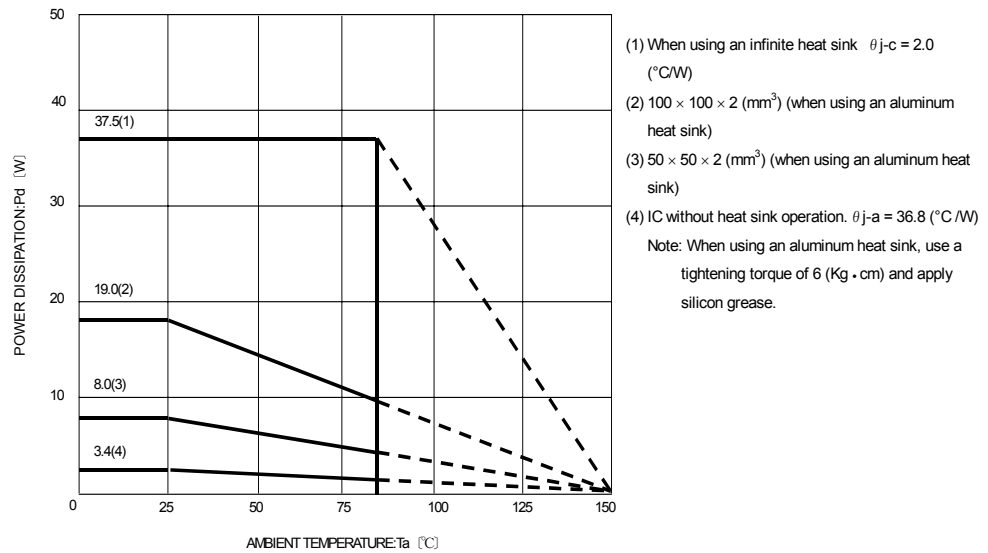

Fig.46 Power Dissipation Characteristics

Refer to the heat reduction characteristics illustrated in Fig. 46 when using the IC in an environment where $T_a \geq 25^{\circ}\text{C}$. The characteristics of the IC are greatly influenced by the operating temperature. If the temperature is in excess of the maximum junction temperature T_{jmax} , the elements of the IC may be deteriorated or damaged. It is necessary to give sufficient consideration to the heat of the IC in view of two points; First, the protection of the IC from instantaneous damage and second, the maintenance of the reliability of the IC in long-time operation.

In order to protect the IC from thermal destruction, it is necessary to operate the IC below the maximum junction temperature T_{jmax} . The chip's (junction area) temperature T_j may rise considerably even when the IC is being used at room temperature (25°C). Always operate the IC within the power dissipation P_d .

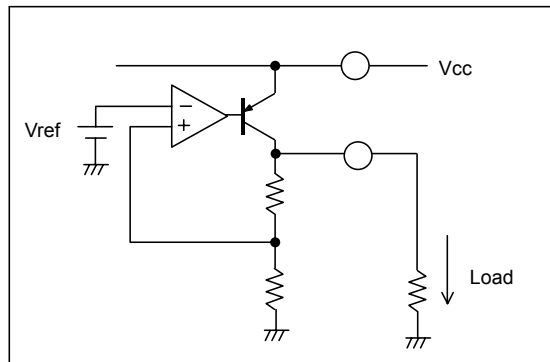

Fig.47

The maximum power consumption P_{MAX} (W) can be calculated as described below, where A denotes the maximum V_{CC1} input voltage and B denotes the maximum V_{CC2} input voltage:

- I_1 = Max. V_{DD} output current
- I_2 = Max. AUDIO output current
- I_3 = Max. P.CON output current
- I_4 = Max. P.ANT output current
- I_5 = Max. AM output current
- I_6 = Max. SW5V output current
- I_7 = Max. ILM output current

- Power consumed by V_{DD} $P_1 = (B-5.0 \text{ V}) \times I_1$
- Power consumed by AUDIO $P_2 = (A-8.12 \text{ V}) \times I_2$
- Power consumed by P.CON $P_3 = 0.7 \text{ V} \times I_3$
- Power consumed by P.ANT $P_4 = 0.7 \text{ V} \times I_4$
- Power consumed by AM $P_5 = (A-7.9 \text{ V}) \times I_5$
- Power consumed by SW5V $P_6 = 0.7 \text{ V} \times I_6$
- Power consumed by ILM $P_7 = (A-10.3 \text{ V}) \times I_7$
- Power consumed by each circuit's current $P_8 = A \times \text{Circuit current}$ (circuit current is approximately 2 mA)

$$P_{MAX} = P_1 + P_2 + P_3 + P_4 + P_5 + P_6 + P_7 + P_8$$

● **Operation Notes**

1. Absolute maximum ratings
An excess in the absolute maximum ratings, such as supply voltage, temperature range of operating conditions, etc., can break down the devices, thus making impossible to identify breaking mode, such as a short circuit or an open circuit. If any over rated values will expect to exceed the absolute maximum ratings, consider adding circuit protection devices, such as fuses.
2. GND voltage
The potential of GND pin must be minimum potential in all operating conditions.
3. Thermal design
Use a thermal design that allows for a sufficient margin in light of the power dissipation (Pd) in actual operating conditions.
4. Inter-pin shorts and mounting errors
Use caution when positioning the IC for mounting on printed circuit boards. The IC may be damaged if there is any connection error or if pins are shorted together.
5. Actions in strong electromagnetic field
Use caution when using the IC in the presence of a strong electromagnetic field as doing so may cause the IC to malfunction.
6. Testing on application boards
When testing the IC on an application board, connecting a capacitor to a pin with low impedance subjects the IC to stress. Always discharge capacitors after each process or step. Always turn the IC's power supply off before connecting it to or removing it from a jig or fixture during the inspection process. Ground the IC during assembly steps as an antistatic measure. Use similar precaution when transporting or storing the IC.

7. Regarding input pin of the IC

This monolithic IC contains P+ isolation and P substrate layers between adjacent elements in order to keep them isolated. P-N junctions are formed at the intersection of these P layers with the N layers of other elements, creating a parasitic diode or transistor. For example, the relation between each potential is as follows:

When $GND > Pin A$ and $GND > Pin B$, the P-N junction operates as a parasitic diode.

When $GND > Pin B$, the P-N junction operates as a parasitic transistor.

Parasitic diodes can occur inevitable in the structure of the IC. The operation of parasitic diodes can result in mutual interference among circuits, operational faults, or physical damage. Accordingly, methods by which parasitic diodes operate, such as applying a voltage that is lower than the GND (P substrate) voltage to an input pin, should not be used.

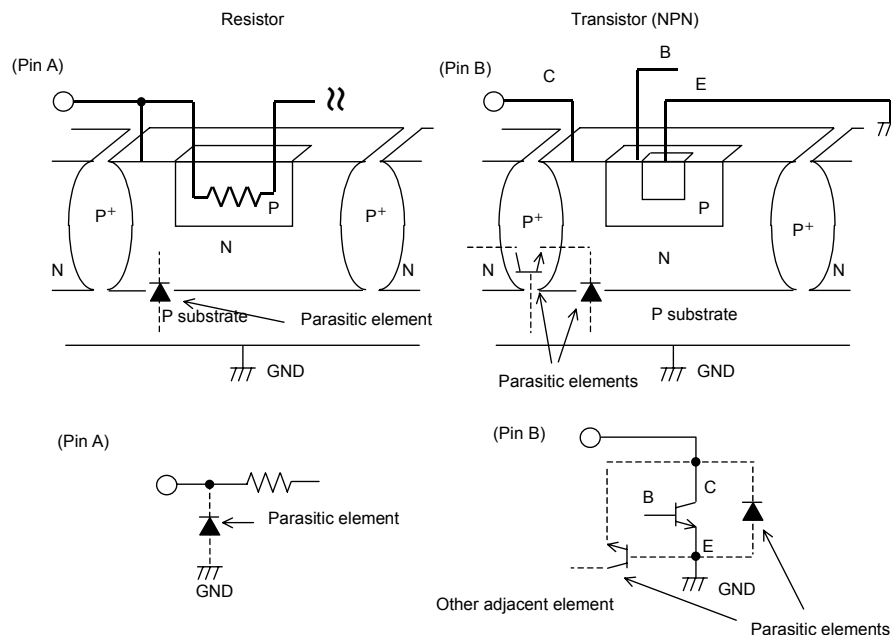

Fig.48 Example of a Simple Monolithic IC Architecture

8. Ground Wiring Pattern

When using both small signal and large current GND patterns, it is recommended to isolate the two ground patterns, placing a single ground point at the ground potential of application so that the pattern wiring resistance and voltage variations caused by large currents do not cause variations in the small signal ground voltage. Be careful not to change the GND wiring pattern of any external components, either.

9. Recommended operating ranges

The circuit functional operations are guaranteed within the Operating Voltage Range and Operating Temperature Range. Although standard electrical characteristics values are not guaranteed, characteristics values will not vary suddenly within these ranges. However, careful consideration must be taken in designing the circuit.

10. Output capacitors

Capacitors used to eliminate oscillation must be placed between the VDD (pin 9), AUDIO (pin 7), AM (pin 5), ILM (pin 2), P.CON (pin 4), P.ANT (pin 3), and SW5V (pin 8) output pins and the GND pin.

Connect a capacitance of at least 0.1 μ F. Ceramic capacitors can be used. Abrupt input voltage and load fluctuations can affect output voltages. Output capacitor capacitance values should be determined after sufficient testing using the actual application.

11. Applications or inspection processes with modes where the potentials of the Vcc pin and other pins may be reversed from their normal states may cause damage to the IC's internal circuitry or elements. For example, such damage might occur when Vcc is shorted with the GND pin while an external capacitor is charged. Use capacitors that fall within the range listed for each pin in Table 1. It is recommended to insert a diode to prevent back current flow in series with Vcc, or bypass diodes between Vcc and each pin. If the Vcc pin carries a lower voltage than the GND pin, insert a protective diode between the Vcc and GND pins.

Output pin	Output capacitor
VDD	0.1 μ F to 2200 μ F
SW5V	0.1 μ F to 2200 μ F
AUDIO	0.1 μ F to 220 μ F
AM	0.1 μ F to 2200 μ F
P.CON	0.1 μ F to 10 μ F
P.ANT	0.1 μ F to 10 μ F
ILM	0.1 μ F to 47 μ F

Table 1

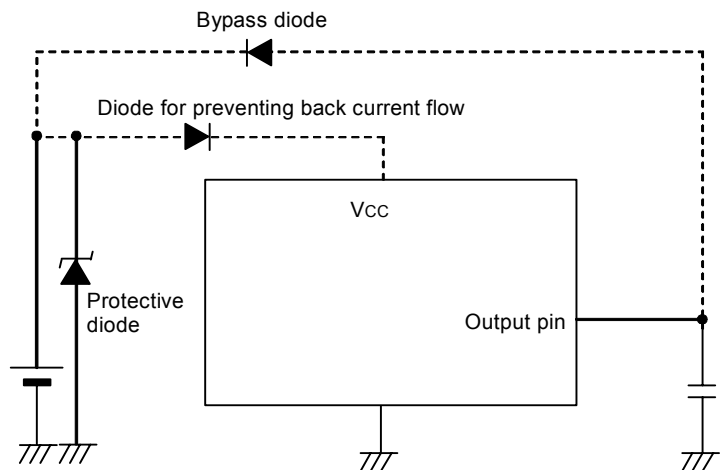

Fig.49 Example of Bypass Diode Insertion to Prevent Back Current Flow

12. Overcurrent protection circuits

The IC incorporates built-in overcurrent protection circuits for the VDD (pin 9), AUDIO (pin 7), AM (pin 5), ILM (pin 2), P.CON (pin 4), P.ANT (pin 3), and SW5V (pin 8) output pins. Each circuit is specifically designed for the current capacity of the corresponding pin and acts to prevent damage to the IC when an overcurrent flows. The protection circuits use dropping fold-back type current limiting and are designed to limit current flow by not latching up in the event of a large and instantaneous current flow, originating from a large capacitor or other component. Their design allows for sufficient safety margins.

These protection circuits are effective in preventing damage due to sudden and unexpected accidents. However, the IC should not be used in applications characterized by the continuous operation or transitioning of the protection circuits (for example, applications where the IC is continuously connected to a load that significantly exceeds the output current capacity). Use caution regarding thermal design, as the output current capacity varies negatively with the temperature characteristics.

13. Overvoltage protection circuit

The overvoltage protection circuit is designed to turn off all output other than VDD and SW5V output when the voltage differential between the Vcc1 (pin 6) and GND (pin 1) pins exceeds approximately 30 V (at room temperature). VDD and SW5V output are turned off when the voltage differential between the Vcc2 (pin 10) and GND (pin 1) pins exceeds approximately 30 V (at room temperature).

Use caution when determining the supply voltage range to use.

14. Thermal shutdown circuit (TSD circuit)

The IC incorporates a built-in thermal shutdown circuit (TSD circuit). However, in the event that the IC continues to be operated in excess of its power dissipation limits, the attendant rise in the chip's temperature T_j will trigger the thermal shutdown circuit to turn off all output power elements. The circuit will automatically reset once the chip's temperature T_j drops. The thermal shutdown circuit (TSD circuit) is designed only to shut the IC off to prevent runaway thermal operation. It is not designed to protect the IC or guarantee its operation. Do not continue to use the IC after operating this circuit or use the IC in an environment where the operation of this circuit is assumed.

15. Ground patterns

Pattern routes connecting the ground points, indicated in application circuits example, to the GND pin (pin 1) should be sufficiently short and should be positioned to avoid electrical interference.

16. Bypass capacitors between the Vcc1/Vcc2 and GND pins

It is recommended to insert a bypass capacitor from 0.47 μF to 10 mF between the Vcc1/Vcc2 and GND pins, positioning it as close as possible to the pins.

17. Grounding the P.CON and P.ANT pins

When the IC's GND pin (pin 1) is open and the P.CON (pin 4) and P.ANT (pin 3) pins are connected to a negative battery terminal (are grounded), a parasitic element may occur inside the IC, resulting in damage. To prevent such damage, it is recommended to insert a schottky diode between the P.CON and P.ANT pins and the GND pin. (See Fig. 50.)

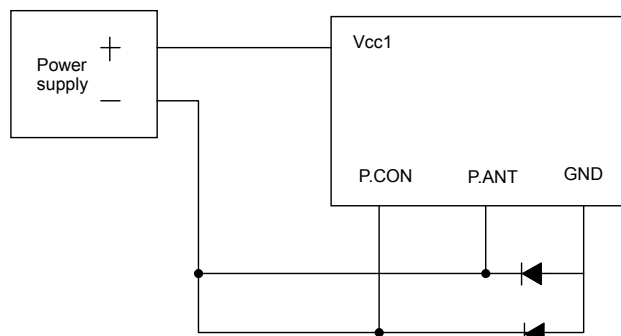

Fig.50 Ground Prevention Circuit Diagram

18. Applications with modes where the potentials of the input (Vcc1) and GND pins and other output pins may be reversed from their normal states may cause damage to the IC's internal circuitry. In particular, it is recommended to create a bypass route with diodes or other components when loads including large inductance components are connected as with the P.ANT and P.CON pins in applications, where BEMF may be generated during startup or when output is turned off.

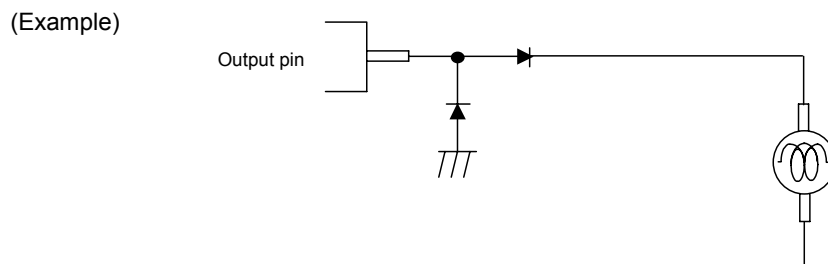
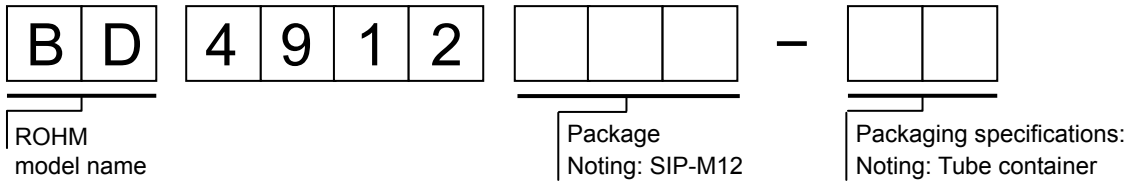

Fig.51 Example of Protective Diode Insertion

19. Always verify the characteristics of example application circuits prior to their use. When changing other external circuit constants, allow for sufficient margins after considering the variability of both the ROHM IC and external components, including both static and transient characteristics.

●Selecting a model name when ordering



SIP-M12

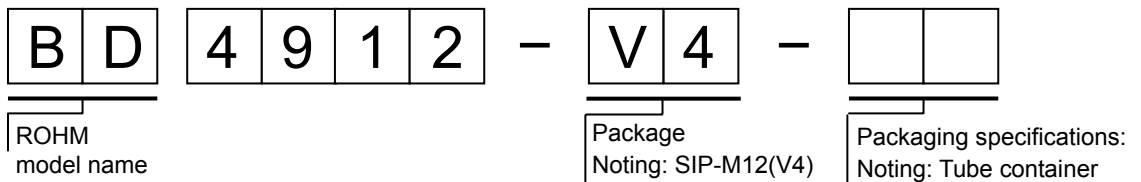
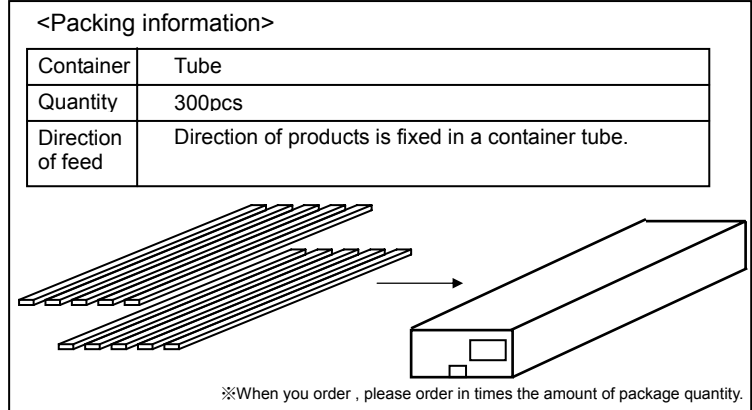
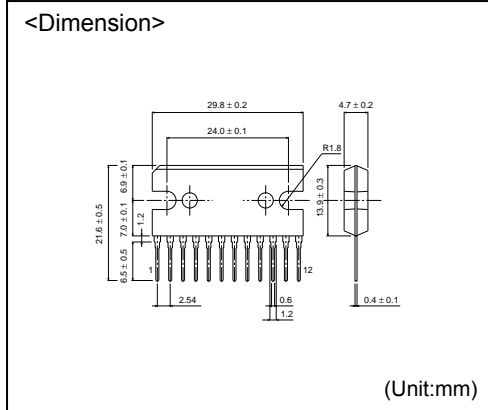

SIP-M12(V4)

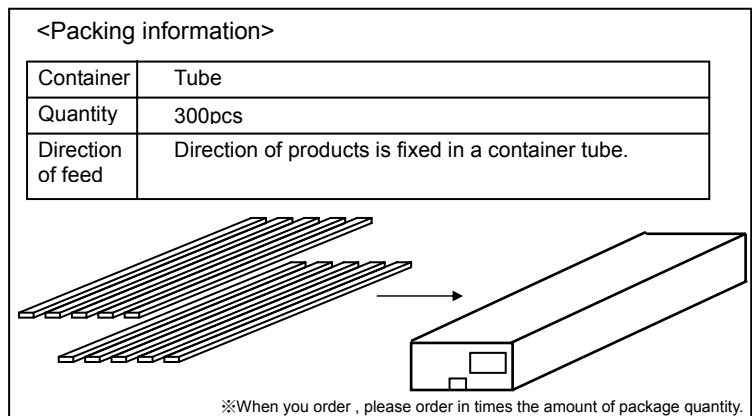
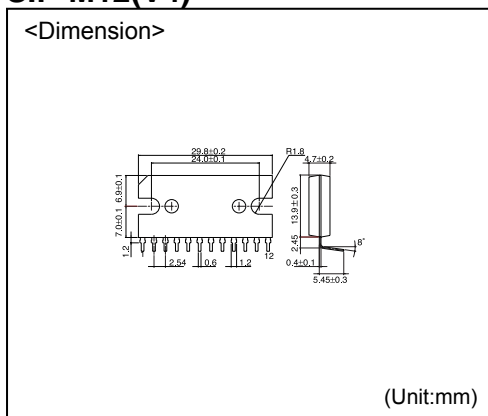

- The contents described herein are correct as of October, 2005
- The contents described herein are subject to change without notice. For updates of the latest information, please contact and confirm with ROHM CO.,LTD.
- Any part of this application note must not be duplicated or copied without our permission.
- Application circuit diagrams and circuit constants contained herein are shown as examples of standard use and operation. Please pay careful attention to the peripheral conditions when designing circuits and deciding upon circuit constants in the set.
- Any data, including, but not limited to application circuit diagrams and information, described herein are intended only as illustrations of such devices and not as the specifications for such devices. ROHM CO.,LTD. disclaims any warranty that any use of such devices shall be free from infringement of any third party's intellectual property rights or other proprietary rights, and further, assumes no liability of whatsoever nature in the event of any such infringement, or arising from or connected with or related to the use of such devices.
- Upon the sale of any such devices, other than for buyer's right to use such devices itself, resell or otherwise dispose of the same, implied right or license to practice or commercially exploit any intellectual property rights or other proprietary rights owned or controlled by ROHM CO., LTD. is granted to any such buyer.
- The products described herein utilize silicon as the main material.
- The products described herein are not designed to be X ray proof.

The products listed in this catalog are designed to be used with ordinary electronic equipment or devices (such as audio visual equipment, office-automation equipment, communications devices, electrical appliances and electronic toys). Should you intend to use these products with equipment or devices which require an extremely high level of reliability and the malfunction of which would directly endanger human life (such as medical instruments, transportation equipment, aerospace machinery, nuclear-reactor controllers, fuel controllers and other safety devices), please be sure to consult with our sales representative in advance.

Excellence in Electronics

ROHM

ROHM CO., LTD.

21, Saiin Mizosaki-cho, Ukyo-ku, Kyoto
615-8585, Japan
TEL: (075)311-2121 FAX: (075)315-0172
URL <http://www.rohm.com>

Published by
Application Engineering Group

Contact us for further information about the products.

Atlanta U.S.A. / ROHM ELECTRONICS ATLANTA SALES OFFICE
(DIVISION OF ROHM ELE. U.S.A.,LLC)
TEL: +1(770)754-8972 FAX: +1(770)754-0891

Dallas U.S.A. / ROHM ELECTRONICS DALLAS SALES OFFICE
(DIVISION OF ROHM ELE. U.S.A.,LLC)
TEL: +1(972)312-8818 FAX: +1(972)312-0330

San Diego U.S.A. / ROHM ELECTRONICS SAN DIEGO SALES OFFICE
(DIVISION OF ROHM ELE. U.S.A.,LLC)
TEL: +1(619)425-3630 FAX: +1(619)425-3670

Germany / ROHM ELECTRONICS GMBH (GERMANY)
TEL: +49(2154)9210 FAX: +49(2154)921400

United Kingdom / ROHM ELECTRONICS GMBH (UK)
TEL: +44(0)1908-306700 FAX: +44(0)1908-235788

France / ROHM ELECTRONICS GMBH (FRANCE)
TEL: +33(0)1 56 97 30 60 FAX: +33(0)1 56 97 30 80

Hong Kong China / ROHM ELECTRONICS (H.K.) CO., LTD.
TEL: +852(2)7406262 FAX: +852(2)375-8971

Shanghai China / ROHM ELECTRONICS (SHANGHAI) CO., LTD.
TEL: +86(21)6279-2727 FAX: +86(21)6247-2066

Dalian China / ROHM ELECTRONICS TRADING (DALIAN) CO., LTD.
TEL: +86(411)8230-8549 FAX: +86(411)8230-8537

Beijing China / BEIJING REPRESENTATIVE OFFICE
TEL: +86(10)8525-2483 FAX: +86(10)8525-2489

Taiwan / ROHM ELECTRONICS TAIWAN CO., LTD.
TEL: +886(2)2500-8956 FAX: +886(2)2503-2869

Korea / ROHM ELECTRONICS KOREA CORPORATION
TEL: +82(2)8182-700 FAX: +82(2)8182-715

Singapore / ROHM ELECTRONICS ASIA PTE. LTD. (RES/REI)
TEL: +65-6332-2322 FAX: +65-6332-6662

Malaysia / ROHM ELECTRONICS (MALAYSIA) SDN. BHD.
TEL: +60(3)7958-8355 FAX: +60(3)7958-8377

Philippines / ROHM ELECTRONICS (PHILIPPINES) SALES CORPORATION
TEL: +63(2)807-8872 FAX: +63(2)809-1422

Thailand / ROHM ELECTRONICS (THAILAND) CO., LTD.
TEL: +66(2)254-4830 FAX: +66(2)256-6334

Catalog No.05T385Be '05.10 ROHM©1000 TSU

Notes

- No technical content pages of this document may be reproduced in any form or transmitted by any means without prior permission of ROHM CO.,LTD.
- The contents described herein are subject to change without notice. The specifications for the product described in this document are for reference only. Upon actual use, therefore, please request that specifications to be separately delivered.
- Application circuit diagrams and circuit constants contained herein are shown as examples of standard use and operation. Please pay careful attention to the peripheral conditions when designing circuits and deciding upon circuit constants in the set.
- Any data, including, but not limited to application circuit diagrams information, described herein are intended only as illustrations of such devices and not as the specifications for such devices. ROHM CO.,LTD. disclaims any warranty that any use of such devices shall be free from infringement of any third party's intellectual property rights or other proprietary rights, and further, assumes no liability of whatsoever nature in the event of any such infringement, or arising from or connected with or related to the use of such devices.
- Upon the sale of any such devices, other than for buyer's right to use such devices itself, resell or otherwise dispose of the same, no express or implied right or license to practice or commercially exploit any intellectual property rights or other proprietary rights owned or controlled by
- ROHM CO., LTD. is granted to any such buyer.
- Products listed in this document are no antiradiation design.

The products listed in this document are designed to be used with ordinary electronic equipment or devices (such as audio visual equipment, office-automation equipment, communications devices, electrical appliances and electronic toys).

Should you intend to use these products with equipment or devices which require an extremely high level of reliability and the malfunction of which would directly endanger human life (such as medical instruments, transportation equipment, aerospace machinery, nuclear-reactor controllers, fuel controllers and other safety devices), please be sure to consult with our sales representative in advance.

It is our top priority to supply products with the utmost quality and reliability. However, there is always a chance of failure due to unexpected factors. Therefore, please take into account the derating characteristics and allow for sufficient safety features, such as extra margin, anti-flammability, and fail-safe measures when designing in order to prevent possible accidents that may result in bodily harm or fire caused by component failure. ROHM cannot be held responsible for any damages arising from the use of the products under conditions out of the range of the specifications or due to non-compliance with the NOTES specified in this catalog.

Thank you for your accessing to ROHM product informations.

More detail product informations and catalogs are available, please contact your nearest sales office.

ROHM Customer Support System

THE AMERICAS / EUROPE / ASIA / JAPAN

www.rohm.com

Contact us : webmaster@rohm.co.jp