



10W Mono Class D Speaker Amplifier with Volume Control

MAX9768

General Description

The MAX9768 mono 10W Class D speaker amplifier provides high-quality, efficient audio power with an integrated volume control function.

The MAX9768 features a 64-step dual-mode (analog or digitally programmable) volume control and mute function. The audio amplifier operates from a 4.5V to 14V single supply and can deliver up to 10W into an 8 Ω speaker with a 14V supply.

A selectable spread-spectrum mode reduces EMI-radiated emissions, allowing the device to pass EMC testing with ferrite bead filters and cable lengths up to 1m. The MAX9768 can be synchronized to an external clock, allowing synchronization of multiple Class D amplifiers.

The MAX9768 features high 77dB PSRR, low 0.08% THD+N, and SNR up to 97dB. Robust short-circuit and thermal-overload protection prevent device damage during a fault condition. The MAX9768 is available in a 24-pin thin QFN-EP (4mm x 4mm x 0.8mm) package and is specified over the extended -40°C to +85°C temperature range.

Applications

Notebook Computers
Flat-Panel Displays
Multimedia Monitors

GPS Navigation Systems
Security/Personal Mobile Radio

Features

- ◆ 10W Output (8 Ω , $P_{VDD} = 14V$, THD+N = 10%)
- ◆ Patented Spread-Spectrum Modulation
- ◆ Meets EN55022B EMC with Ferrite Bead Filters
- ◆ Amplifier Operation from 4.5V to 14V Supply
- ◆ 64-Step Integrated Volume Control (I²C or Analog)
- ◆ Low 0.08% THD+N ($R_L = 8\Omega$, $P_{OUT} = 6W$)
- ◆ High 77dB PSRR
- ◆ Two t_{ON} Times Offered
MAX9768—220ms
MAX9768B—15ms
- ◆ Low-Power Shutdown Mode (0.5 μ A)
- ◆ Short-Circuit and Thermal-Overload Protection

Ordering Information

PART	PIN-PACKAGE	t_{ON} (ms)	PKG CODE
MAX9768ETG+	24 TQFN-EP*	220	T2444+4
MAX9768BETG+	24 TQFN-EP*	15	T2444+4

Note: All devices are specified over the -40°C to +85°C operating temperature range.

+ Denotes lead-free package.

*EP = Exposed pad.

Pin Configuration located at end of data sheet.

Simplified Block Diagram

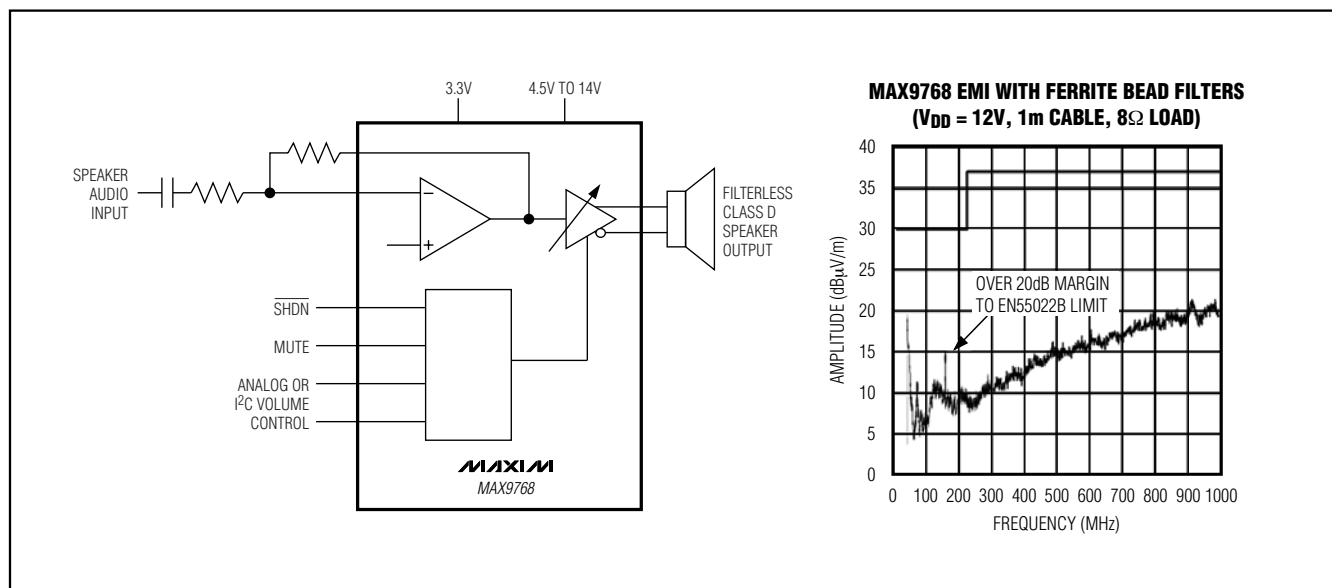

10W Mono Class D Speaker Amplifier with Volume Control

ABSOLUTE MAXIMUM RATINGS

PVDD to PGND	-0.3V to +16V
VDD to GND	-0.3V to +4V
SCLK, SDA/VOL to GND	-0.3V to +4V
FB, SYNCOUT	-0.3V to (VDD + 0.3V)
BOOT_ to OUT_	-0.3V to +4V
OUT_ to GND	-0.3V to (PVDD + 0.3V)
PGND to GND	-0.3V to +0.3V
Any Other Pin to GND	-0.3V to +4V
OUT_ Short-Circuit Duration	Continuous
Continuous Current (PVDD, PGND, OUT_)	2.2A
Continuous Input Current (Any Other Pin)	±20mA
Continuous Input Current (FB_)	±60mA

Continuous Power Dissipation (TA = +70°C)

Single-Layer Board:

24-Pin Thin QFN 4mm x 4mm,

(derate 20.8mW/°C above +70°C).....1.67W

Multilayer Board:

24-Pin Thin QFN 4mm x 4mm,

(derate 27.8mW/°C above +70°C).....2.22W

θJA, Single-Layer Board.....48°C/W

θJA, Multilayer Board.....36°C/W

Operating Temperature Range.....-40°C to +85°C

Storage Temperature Range.....-65°C to +150°C

Lead Temperature (soldering, 10s).....+300°C

Stresses beyond those listed under "Absolute Maximum Ratings" may cause permanent damage to the device. These are stress ratings only, and functional operation of the device at these or any other conditions beyond those indicated in the operational sections of the specifications is not implied. Exposure to absolute maximum rating conditions for extended periods may affect device reliability.

ELECTRICAL CHARACTERISTICS

(PVDD = 12V, VDD = 3.3V, GND = PGND = 0V, VSHDN = VDD, VMUTE = 0V; Max volume setting; speaker load resistor connected between OUT+ and OUT-, RL = ∞, unless otherwise noted. CBIAS = 2.2μF, C1 = C2 = 0.1μF, CIN = 0.47μF, RIN = 20kΩ, RF = 30kΩ, SSM mode. Filterless modulation mode (see the Functional Diagram/Typical Application Circuit). TA = TMIN to TMAX, unless otherwise noted. Typical values are at TA = +25°C.) (Note 1)

PARAMETER	SYMBOL	CONDITIONS		MIN	TYP	MAX	UNITS
GENERAL							
Speaker Supply Voltage Range	PVDD	Inferred from PSRR test		4.5		14.0	V
Supply Voltage Range	VDD	Inferred from PSRR and UVLO test		2.7		3.6	V
Quiescent Current	IVDD				7	14.2	mA
	IPVDD	Filterless modulation			4	7.6	
		Classic PWM modulation			4	7.6	
Shutdown Current	ISHDN	ISHDN = IPVDD + IDD, SHDN = GND			0.5	50	μA
Output Offset	VOS	Filterless modulation, VMUTE = VDD, TA = +25°C			±2	±12.5	mV
		Filterless modulation, VMUTE = 0V, TA = +25°C			±2	±14	
Turn-On Time	tON	MAX9768			220		ms
		MAX9768B			15		
Common-Mode Bias Voltage	VBIAS				1.5		V
Input Amplifier Output-Voltage Swing High	VOH	Specified as VDD - VOH	RL = 2kΩ connect to 1.5V		3.6	100	mV
Input Amplifier Output-Voltage Swing Low	VOL	Specified as VOL - GND	RL = 2kΩ connect to 1.5V		6	50	mV
Input Amplifier Output Short-Circuit Current Limit					±60		mA
Input Amplifier Gain-Bandwidth Product	GBW				1.8		MHz
SPEAKER AMPLIFIERS							
Internal Gain	AVMAX	Max volume setting; from FB to amplifier outputs I(OUT+) - (OUT-); excludes external gain resistors		29.27	30.1	31.00	dB

10W Mono Class D Speaker Amplifier with Volume Control

MAX9768

ELECTRICAL CHARACTERISTICS (continued)

($P_{VDD} = 12V$, $V_{DD} = 3.3V$, $GND = PGND = 0V$, $V_{SHDN} = V_{DD}$, $V_{MUTE} = 0V$; Max volume setting; speaker load resistor connected between $OUT+$ and $OUT-$, $R_L = \infty$, unless otherwise noted. $C_{BIAS} = 2.2\mu F$, $C_1 = C_2 = 0.1\mu F$, $C_{IN} = 0.47\mu F$, $R_{IN} = 20k\Omega$, $R_F = 30k\Omega$, SSM mode. Filterless modulation mode (see the *Functional Diagram/Typical Application Circuit*). $T_A = T_{MIN}$ to T_{MAX} , unless otherwise noted. Typical values are at $T_A = +25^\circ C$.) (Note 1)

PARAMETER	SYMBOL	CONDITIONS		MIN	TYP	MAX	UNITS
Efficiency (Note 2)	η	$P_{OUT} = 8W$, $f_{IN} = 1kHz$, $R_L = 8\Omega$	Filterless modulation		87		%
			Classic PWM modulation		85		
Output Power (Note 2)	P_{OUT}	$P_{VDD} = 5V$	$R_L = 8\Omega$, THD+N = 1%, filterless modulation		1.3		W
			$R_L = 8\Omega$, THD+N = 10%, filterless modulation		1.7		
		$P_{VDD} = 12V$	$R_L = 8\Omega$, THD+N = 10%, classic PWM modulation		9		
			$R_L = 8\Omega$, THD+N = 10%, filterless modulation		9		
		$P_{VDD} = 14V$	$R_L = 8\Omega$, THD+N = 10%, classic PWM modulation		10		
			$R_L = 8\Omega$, THD+N = 10%, filterless modulation		10		
Soft Output Current Limit	I_{LIM}			1.75	2		A
Hard Output Current Limit	I_{SC}				2.5		A
Total Harmonic Distortion Plus Noise (Note 2)	THD+N	$f = 1kHz$, $R_L = 8\Omega$, $P_{OUT} = 5W$	Filterless modulation		0.09		%
			Classic PWM modulation		0.08		
Signal-to-Noise Ratio (Note 2)	SNR	0dB = 8W, $R_L = 8\Omega$, BW = 22Hz to 22kHz, filterless modulation mode	Unweighted	FFM		94	dB
				SSM		93	
			A-weighted	FFM		97	
				SSM		97	
		0dB = 8W, $R_L = 8\Omega$, BW = 22Hz to 22kHz, classic PWM modulation	Unweighted	FFM		93	
				SSM		89	
A-weighted	FFM		97				
	SSM		91				
MUTE Attenuation (Note 3)		0dB = 8W, $f = 1kHz$			115		dB
Power-Supply Rejection Ratio	PSRR	$V_{DD} = 2.7V$ to $3.6V$, filterless modulation, $T_A = +25^\circ C$		52	68		dB
		$P_{VDD} = 4.5V$ to $14V$, filterless modulation, $T_A = +25^\circ C$		67	84		
		$f = 1kHz$, $V_{RIPPLE} = 200mV_{P-P}$ on P_{VDD}			77		
		$f = 1kHz$, $V_{RIPPLE} = 100mV_{P-P}$ on V_{DD}			60		
Oscillator Frequency	f_{OCS}	SYNC = GND		1060	1200	1320	kHz
		SYNC = unconnected		1296	1440	1584	
		SYNC = V_{DD} (spread-spectrum modulation mode)			1200	± 30	

10W Mono Class D Speaker Amplifier with Volume Control

ELECTRICAL CHARACTERISTICS (continued)

($P_{VDD} = 12V$, $V_{DD} = 3.3V$, $GND = PGND = 0V$, $V_{SHDN} = V_{DD}$, $V_{MUTE} = 0V$; Max volume setting; speaker load resistor connected between $OUT+$ and $OUT-$, $R_L = \infty$, unless otherwise noted. $C_{BIAS} = 2.2\mu F$, $C_1 = C_2 = 0.1\mu F$, $C_{IN} = 0.47\mu F$, $R_{IN} = 20k\Omega$, $R_F = 30k\Omega$, SSM mode. Filterless modulation mode (see the *Functional Diagram/Typical Application Circuit*). $T_A = T_{MIN}$ to T_{MAX} , unless otherwise noted. Typical values are at $T_A = +25^\circ C$.) (Note 1)

PARAMETER	SYMBOL	CONDITIONS	MIN	TYP	MAX	UNITS
Class D Switching Frequency		SYNC = GND	265	300	330	kHz
		SYNC = unconnected	324	360	396	
		SYNC = V_{DD} (spread-spectrum modulation mode)		300 ± 7.5		
SYNC Frequency Lock Range			1000		1600	kHz
Minimum SYNC Frequency Lock Duty Cycle				40		%
Maximum SYNC Frequency Lock Duty Cycle				60		%
Gain Matching		Full volume (ideal matching for R_{IN} and R_F)		2		%
Click-and-Pop Level (Note 2)	K_{CP}	Peak voltage, 32 samples per second, A-weighted, $R_{IN} \times C_{IN} \leq 10ms$ to guarantee clickless/popless operation	Into shutdown		52.6	dBV
			Out of shutdown		48	
			Into mute		67	
			Out of mute		57	
Input Impedance		DC volume control mode (SDA/VOL)		100		$M\Omega$
Input Hysteresis		DC volume control mode (SDA/VOL)		11		mV
9.5dB Gain Voltage		DC volume control mode (SDA/VOL)		$0.1 \times V_{DD}$		V
Full Mute Voltage		DC volume control mode (SDA/VOL)		$0.9 \times V_{DD}$		V
DIGITAL INPUTS (SHDN, MUTE, ADDR1, ADDR2, SYNC)						
Input-Voltage High	V_{IH}	SYNC		2.33		V
		All other pins		$0.7 \times V_{DD}$		
Input-Voltage Low	V_{IL}	SYNC			0.8	V
		All other pins			$0.3 \times V_{DD}$	
Input Leakage Current	I_{SYNC}			± 7.5	± 13	μA
	I_{LK}	All other digital inputs			± 1	
DIGITAL OUTPUT (SYNCOUT)						
Output-Voltage High		Load = 1mA		$V_{DD} - 0.3$		V
Output-Voltage Low		Load = 1mA			0.3	V
Rise/Fall Time		$C_L = 10pF$			5	ns

10W Mono Class D Speaker Amplifier with Volume Control

MAX9768

ELECTRICAL CHARACTERISTICS (continued)

($P_{VDD} = 12V$, $V_{DD} = 3.3V$, $GND = PGND = 0V$, $V_{SHDN} = V_{DD}$, $V_{MUTE} = 0V$; Max volume setting; speaker load resistor connected between $OUT+$ and $OUT-$, $R_L = \infty$, unless otherwise noted. $C_{BIAS} = 2.2\mu F$, $C_1 = C_2 = 0.1\mu F$, $C_{IN} = 0.47\mu F$, $R_{IN} = 20k\Omega$, $R_F = 30k\Omega$, SSM mode. Filterless modulation mode (see the *Functional Diagram/Typical Application Circuit*). $T_A = T_{MIN}$ to T_{MAX} , unless otherwise noted. Typical values are at $T_A = +25^\circ C$.) (Note 1)

PARAMETER	SYMBOL	CONDITIONS	MIN	TYP	MAX	UNITS
THERMAL PROTECTION						
Thermal Shutdown Threshold				150		$^\circ C$
Thermal Shutdown Hysteresis				15		$^\circ C$
DIGITAL INPUTS (SCLK, SDA/VOL)						
Input-Voltage High	V_{IH}		$0.7 \times V_{DD}$			V
Input-Voltage Low	V_{IL}		$0.3 \times V_{DD}$			V
Input High Leakage Current	I_{IH}	$V_{IN} = V_{DD}$		± 1		μA
Input Low Leakage Current	I_{IL}	$V_{IN} = GND$		± 1		μA
Input Hysteresis			$0.1 \times V_{DD}$			V
Input Capacitance	C_{IN}		5			pF
DIGITAL OUTPUTS (SDA/VOL)						
Output High Current	I_{OH}	$V_{OH} = V_{DD}$			1	μA
Output Low Voltage	V_{OL}	$I_{OL} = 3mA$			0.4	V
I²C TIMING CHARACTERISTICS (Figure 3)						
Serial Clock	f_{SCL}				400	kHz
Bus Free Time Between a STOP and START Condition	t_{BUF}		1.3			μs
Hold Time (Repeated) START Condition	$t_{HD,STA}$		0.6			μs
Repeated START Condition Setup Time	$t_{SU,STA}$		0.6			μs
STOP Condition Setup Time	$t_{SU,STO}$		0.6			μs
Data Hold Time	$t_{HD,DAT}$		0		0.9	μs
Data Setup Time	$t_{SU,DAT}$		100			ns
SCL Clock Low Period	t_{LOW}		1.3			μs
SCL Clock High Period	t_{HIGH}		0.6			μs
Rise Time of SDA and SCL, Receiving	t_R	(Note 4)	$20 + 0.1C_b$		300	ns
Fall Time of SDA and SCL, Receiving	t_F	(Note 4)	$20 + 0.1C_b$		300	ns

10W Mono Class D Speaker Amplifier with Volume Control

ELECTRICAL CHARACTERISTICS (continued)

($P_{VDD} = 12V$, $V_{DD} = 3.3V$, $GND = PGND = 0V$, $V_{SHDN} = V_{DD}$, $V_{MUTE} = 0V$; Max volume setting; speaker load resistor connected between $OUT+$ and $OUT-$, $R_L = \infty$, unless otherwise noted. $C_{BIAS} = 2.2\mu F$, $C_1 = C_2 = 0.1\mu F$, $C_{IN} = 0.47\mu F$, $R_{IN} = 20k\Omega$, $R_F = 30k\Omega$, SSM mode. Filterless modulation mode (see the *Functional Diagram/Typical Application Circuit*). $T_A = T_{MIN}$ to T_{MAX} , unless otherwise noted. Typical values are at $T_A = +25^\circ C$.) (Note 1)

PARAMETER	SYMBOL	CONDITIONS	MIN	TYP	MAX	UNITS
Fall Time of SDA, Transmitting	t_F	(Note 4)	20 + 0.1Cb		250	ns
Pulse Width of Spike Suppressed	t_{SP}		0		50	ns
Capacitive Load for Each Bus Line	C_b				400	pF

Note 1: All devices are 100% production tested at $T_A = +25^\circ C$. All temperature limits are guaranteed by design.

Note 2: Testing performed with a resistive load in series with an inductor to simulate an actual speaker load. For $R_L = 8\Omega$, $L = 68\mu H$.

Note 3: Device muted by either asserting MUTE or minimum V_{OL} setting.

Note 4: C_b = total capacitance of one bus line in pF.

Typical Operating Characteristics

($P_{VDD} = 12V$, $V_{DD} = 3.3V$, $GND = PGND = 0V$, $V_{MUTE} = 0V$; 0dB volume setting; all speaker load resistors connected between $OUT+$ and $OUT-$, $R_L = 8\Omega$, unless otherwise noted. $C_{BIAS} = 2.2\mu F$, $C_1 = C_2 = 0.1\mu F$, $C_{IN} = 0.47\mu F$, $R_{IN} = 20k\Omega$, $R_{FB} = 30k\Omega$, spread-spectrum modulation mode.)

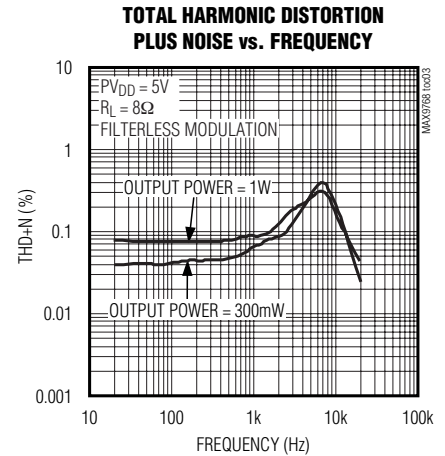
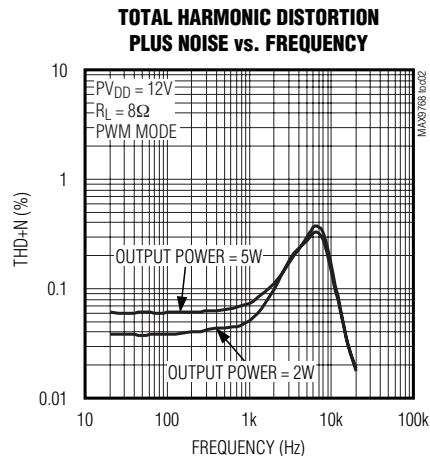
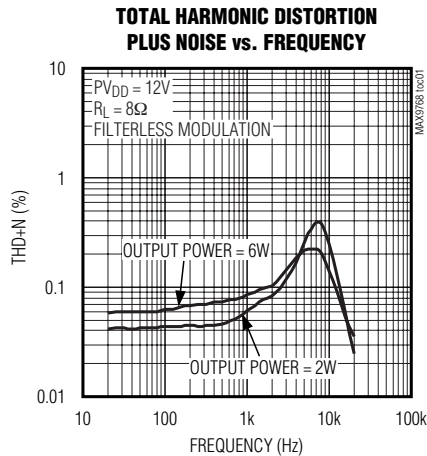

10W Mono Class D Speaker Amplifier with Volume Control

Typical Operating Characteristics (continued)

($P_{VDD} = 12V$, $V_{DD} = 3.3V = GND = PGND = 0V$, $V_{MUTE} = 0V$; 0dB volume setting; all speaker load resistors connected between OUT+ and OUT-, $R_L = 8\Omega$, unless otherwise noted. $C_{BIAS} = 2.2\mu F$, $C_1 = C_2 = 0.1\mu F$, $C_{IN} = 0.47\mu F$, $R_{IN} = 20k\Omega$, $R_{FB} = 30k\Omega$, spread-spectrum modulation mode.)

MAX9768

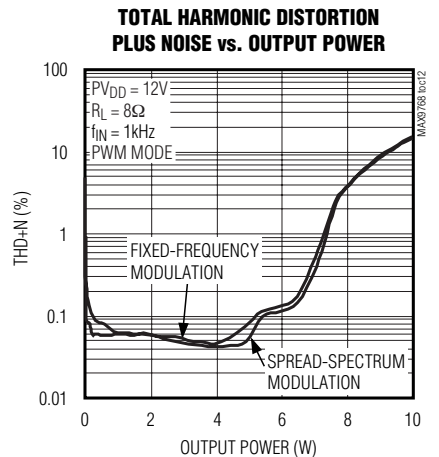
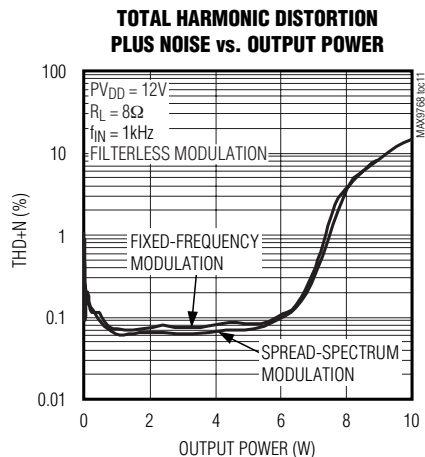
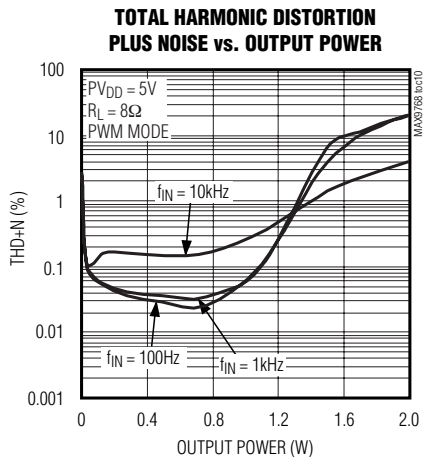
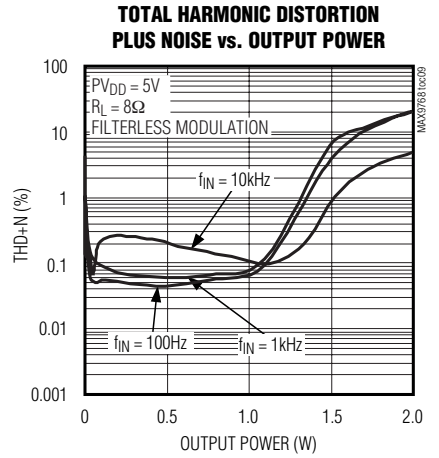
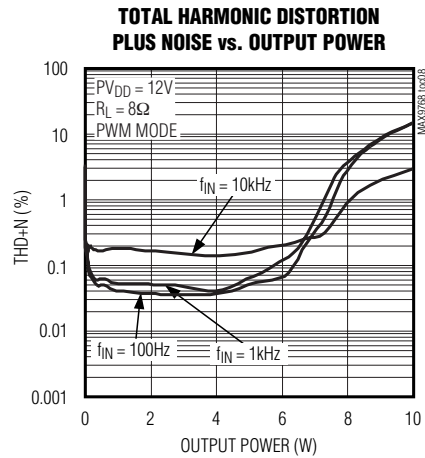
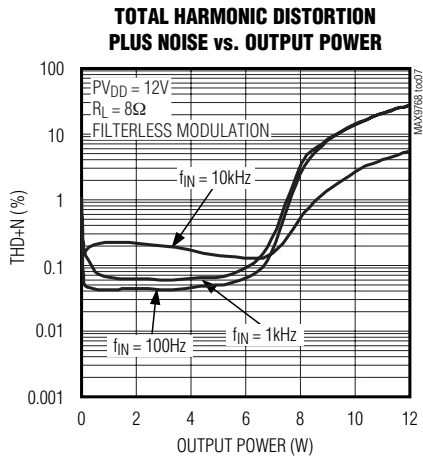
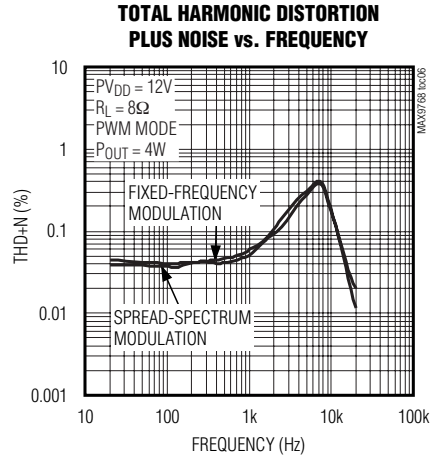
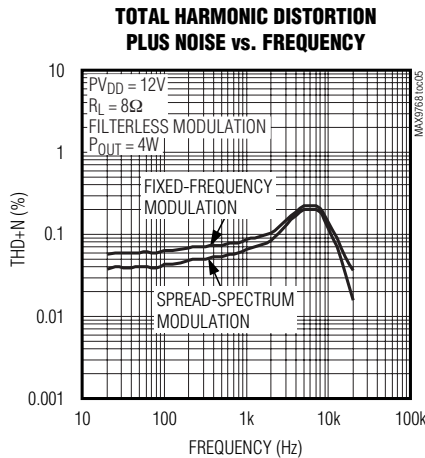
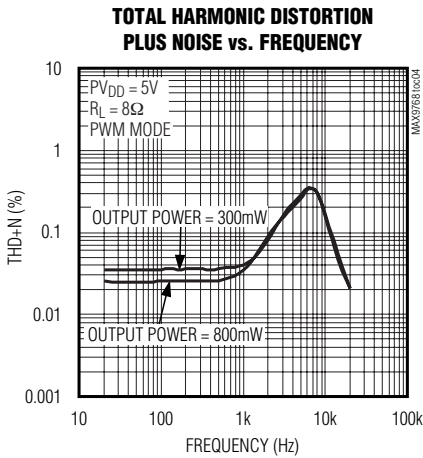

10W Mono Class D Speaker Amplifier with Volume Control

Typical Operating Characteristics (continued)

($P_{VDD} = 12V$, $V_{DD} = 3.3V = GND = PGND = 0V$, $V_{MUTE} = 0V$; 0dB volume setting; all speaker load resistors connected between OUT+ and OUT-, $R_L = 8\Omega$, unless otherwise noted. $C_{BIAS} = 2.2\mu F$, $C1 = C2 = 0.1\mu F$, $C_{IN} = 0.47\mu F$, $R_{IN} = 20k\Omega$, $R_{FB} = 30k\Omega$, spread-spectrum modulation mode.)

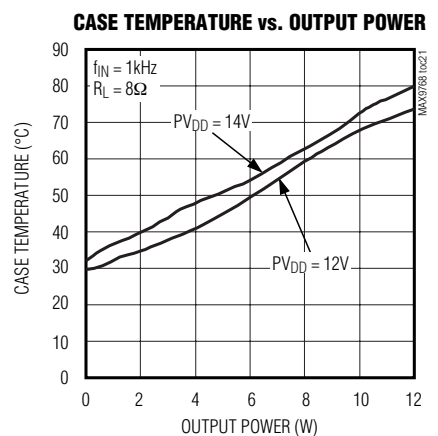
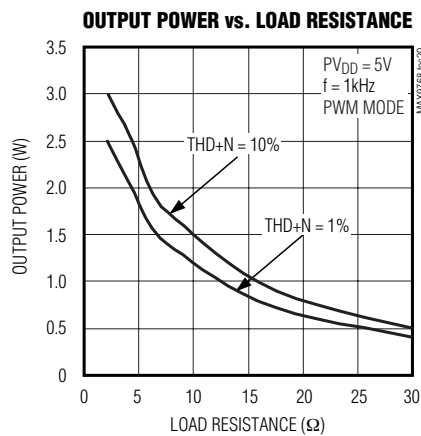
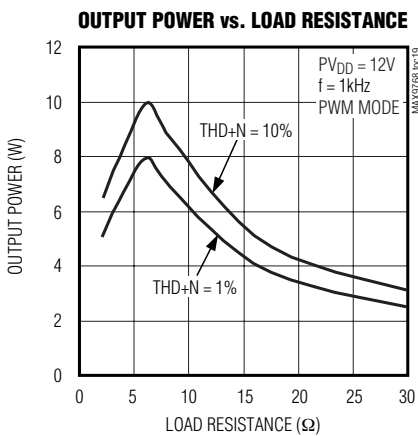
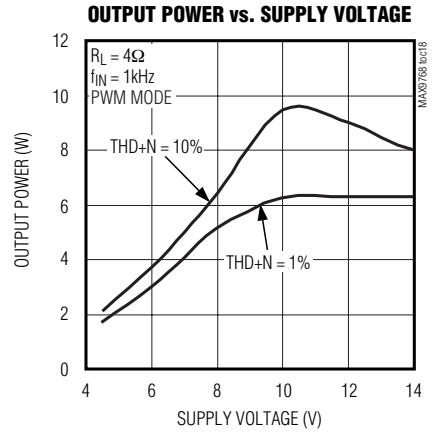
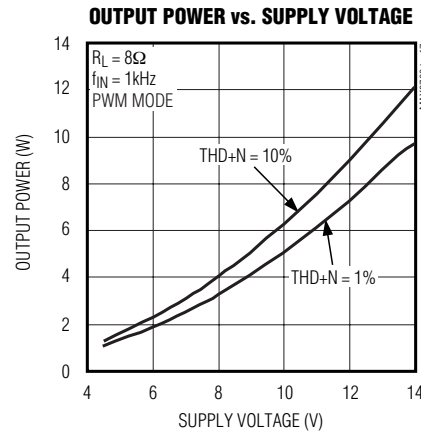
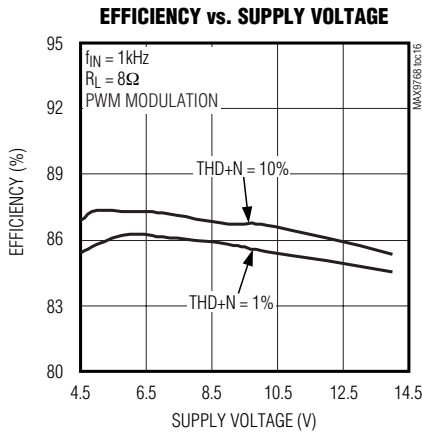
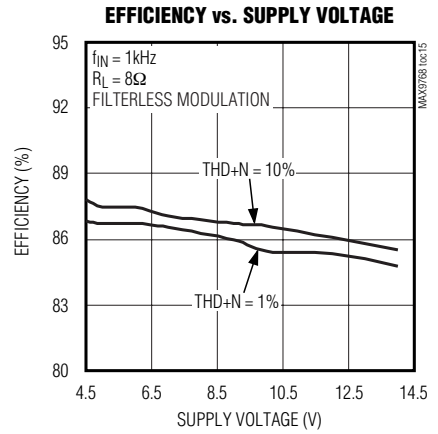
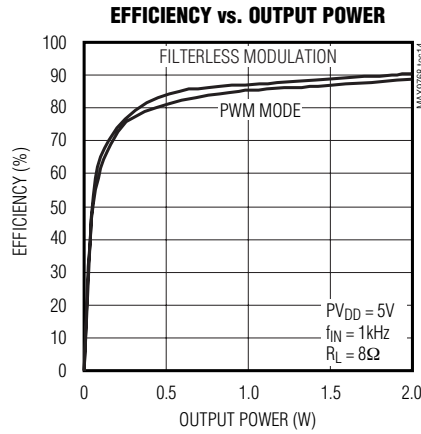
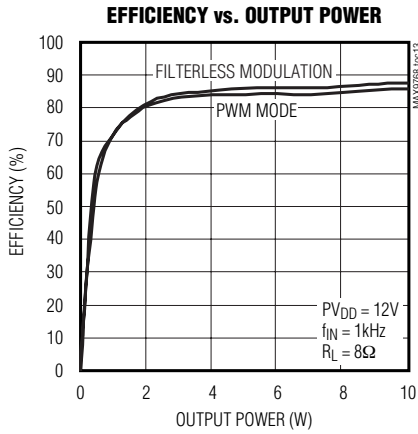

10W Mono Class D Speaker Amplifier with Volume Control

MAX9768

Typical Operating Characteristics (continued)

($PV_{DD} = 12V$, $V_{DD} = 3.3V = GND = PGND = 0V$, $V_{MUTE} = 0V$; 0dB volume setting; all speaker load resistors connected between $OUT+$ and $OUT-$, $R_L = 8\Omega$, unless otherwise noted. $C_{BIAS} = 2.2\mu F$, $C_1 = C_2 = 0.1\mu F$, $C_{IN} = 0.47\mu F$, $R_{IN} = 20k\Omega$, $R_{FB} = 30k\Omega$, spread-spectrum modulation mode.)

POWER-SUPPLY REJECTION RATIO (PVDD) vs. FREQUENCY

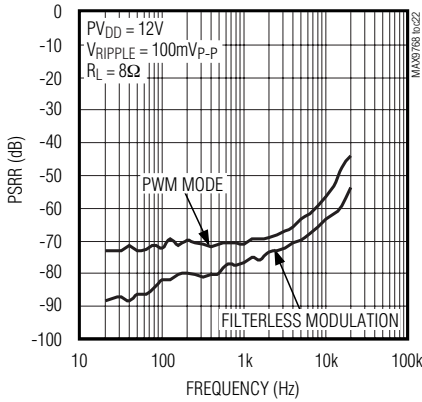

POWER-SUPPLY REJECTION RATIO (VDD) vs. FREQUENCY

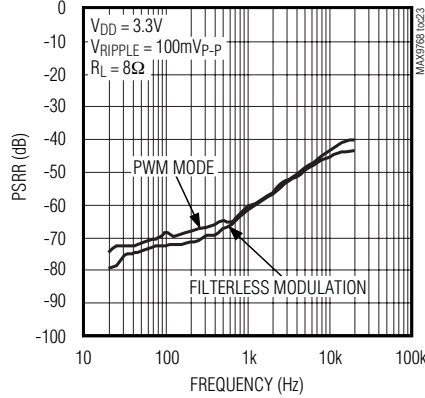

OUTPUT WAVEFORM (FILTERLESS MODULATION)

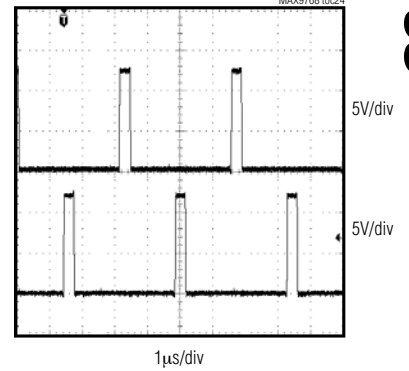

OUTPUT WAVEFORM (PWM MODE)

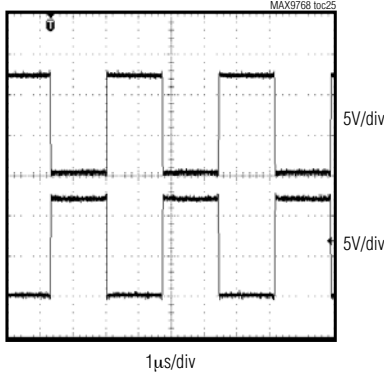

OUTPUT FREQUENCY SPECTRUM

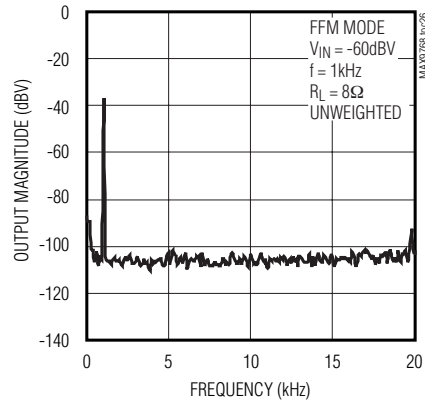

OUTPUT FREQUENCY SPECTRUM

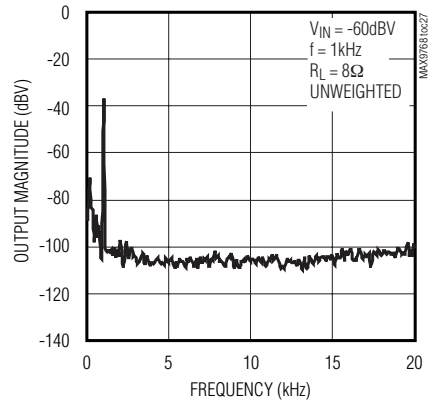

WIDEBAND OUTPUT SPECTRUM (FIXED-FREQUENCY MODULATION MODE)

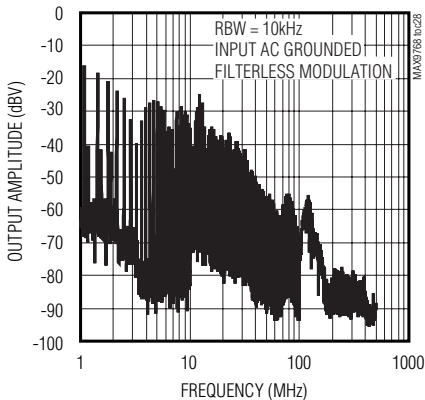

WIDEBAND OUTPUT SPECTRUM (FIXED-FREQUENCY MODULATION MODE)

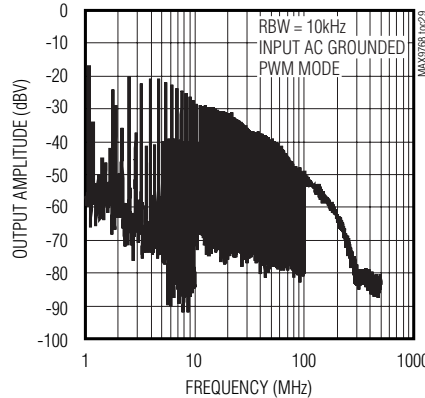

WIDEBAND OUTPUT SPECTRUM (SPREAD-SPECTRUM MODULATION MODE)

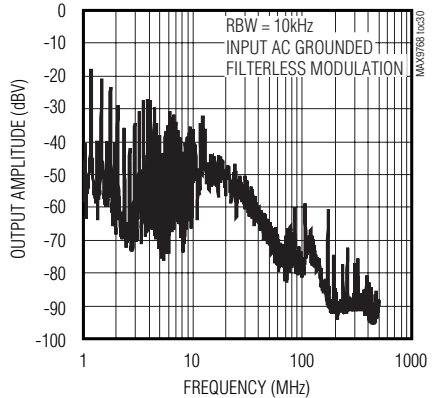

10W Mono Class D Speaker Amplifier with Volume Control

Typical Operating Characteristics (continued)

($P_{VDD} = 12V$, $V_{DD} = 3.3V = GND = PGND = 0V$, $V_{MUTE} = 0V$; 0dB volume setting; all speaker load resistors connected between OUT+ and OUT-, $R_L = 8\Omega$, unless otherwise noted. $C_{BIAS} = 2.2\mu F$, $C_1 = C_2 = 0.1\mu F$, $C_{IN} = 0.47\mu F$, $R_{IN} = 20k\Omega$, $R_{FB} = 30k\Omega$, spread-spectrum modulation mode.)

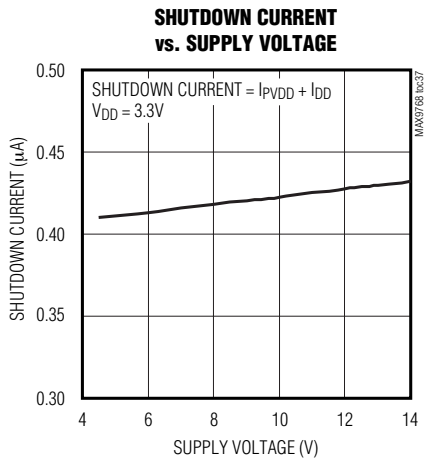
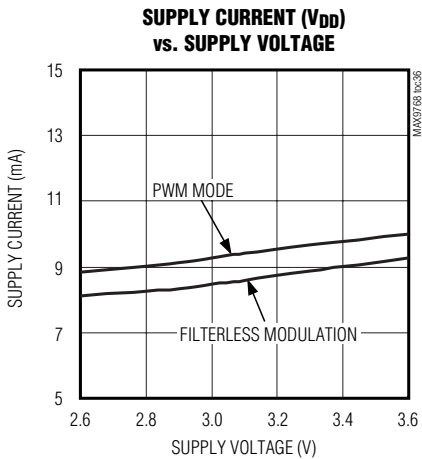
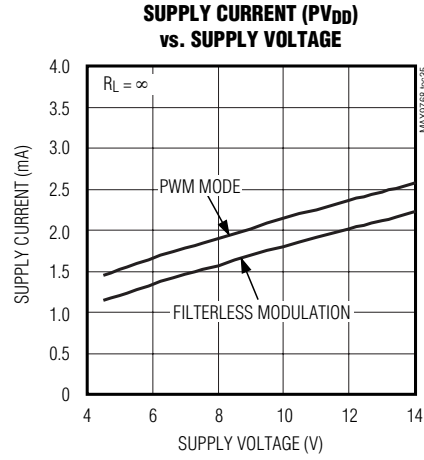
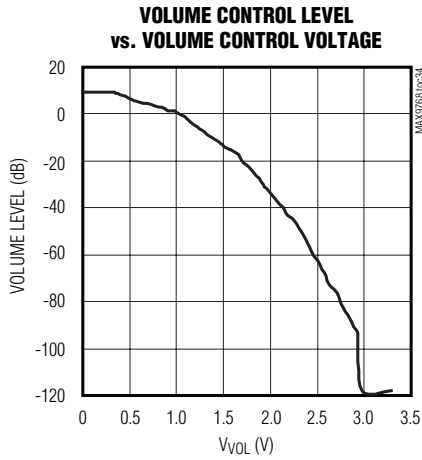
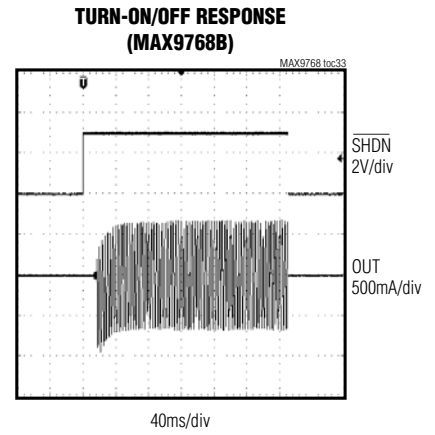
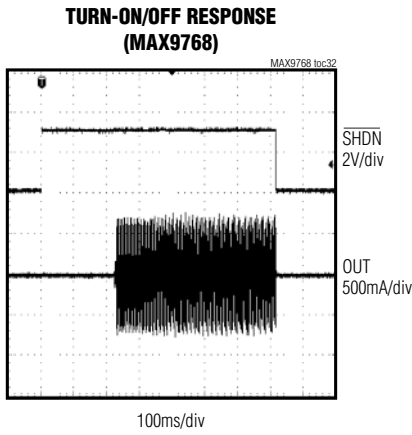
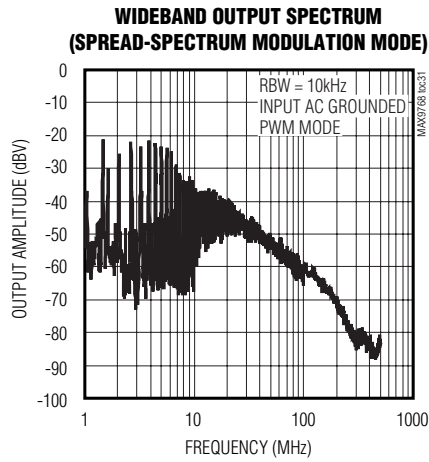

10W Mono Class D Speaker Amplifier with Volume Control

Pin Description

MAX9768

PIN	NAME	FUNCTION
1, 2	OUT+	Positive Speaker Output
3, 16	PVDD	Speaker Amplifier Power-Supply Input. Bypass with a 1 μ F capacitor to ground.
4	BOOT+	Positive Speaker Output Boost Flying-Capacitor Connection. Connect a 0.1 μ F ceramic capacitor between BOOT+ and OUT+.
5	SCLK	I ² C Serial-Clock Input and Modulation Scheme Select. In I ² C mode (ADDR1 and ADDR2 \neq GND) acts as I ² C serial-clock input. When ADDR1 and ADDR2 = GND. Connect SCLK to V _{DD} for classic PWM modulation, or connect SCLK to ground for filterless modulation.
6	SDA/VOL	I ² C Serial Data I/O and Analog Volume Control Input
7	FB	Feedback. Connect feedback resistor between FB and IN to set amplifier gain. See the <i>Adjustable Gain</i> section.
8	IN	Audio Input
9, 11	GND	Ground
10	BIAS	Common-Mode Bias Voltage. Bypass with a 2.2 μ F capacitor to GND.
12	SYNC	Frequency Select and External Clock Input. SYNC = GND: Fixed-frequency mode with $f_S = 1200\text{kHz}$. SYNC = Unconnected: Fixed-frequency mode with $f_S = 1440\text{kHz}$. SYNC = V _{DD} : Spread-spectrum mode with $f_S = 1200\text{kHz} \pm 30\text{kHz}$. SYNC = Clocked: Fixed-frequency mode with $f_S = \text{external clock frequency}$.
13	SYNCOUT	Clock Signal Output
14	V _{DD}	Power-Supply Input. Bypass with a 1 μ F capacitor to GND.
15	BOOT-	Negative Speaker Output Boost Flying-Capacitor Connection. Connect a 0.1 μ F ceramic capacitor between BOOTL- and OUTL-.
17, 18	OUT-	Negative Speaker Output
19	$\overline{\text{SHDN}}$	Shutdown Input. Drive $\overline{\text{SHDN}}$ low to disable the audio amplifiers. Connect $\overline{\text{SHDN}}$ to V _{DD} for normal operation
20	MUTE	Mute Input. Drive MUTE high to mute the speaker outputs. Connect MUTE to GND for normal operation.
21, 22	PGND	Power Ground
23	ADDR2	Address Select Input 2. I ² C address option, also selects volume control mode.
24	ADDR1	Address Select Input 1. I ² C address option, also selects volume control mode.
EP	EP	Exposed Pad. Connect the exposed thermal pad to GND, and use multiple vias to a solid copper area on the bottom of the PCB.

10W Mono Class D Speaker Amplifier with Volume Control

Functional Diagram/Typical Application Circuit

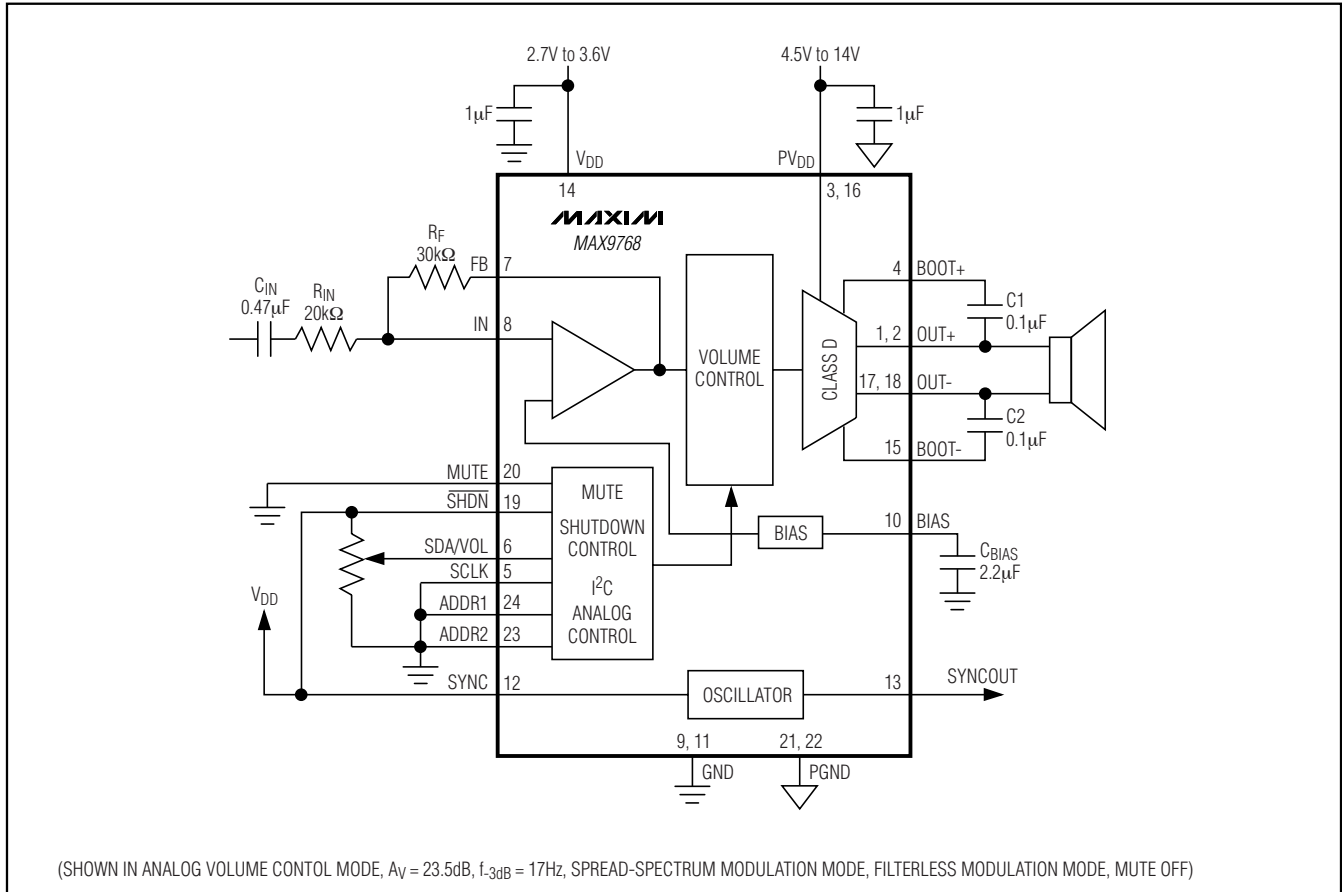

Detailed Description

The MAX9768 10W, Class D audio power amplifier with spread-spectrum modulation provides a significant step forward in switch-mode amplifier technology. The MAX9768 offers Class AB performance with Class D efficiency and a minimal board space solution. This device features a wide supply voltage operation (4.5V to 14V), analog or digitally adjusted volume control, externally set input gain, shutdown mode, SYNC input and output, speaker mute, and industry-leading click-and-pop suppression.

The MAX9768 features a 64-step, dual-mode (analog or I²C programmed) volume control and mute function. In analog volume control mode, voltage applied to SDA/VOL sets the volume level. Two address inputs

(ADDR1, ADDR2) set the volume control function between analog and I²C and set the slave address. In I²C mode there are three selectable slave addresses allowing for multiple devices on a single bus.

Spread-spectrum modulation and synchronizable switching frequency significantly reduce EMI emissions. The outputs use Maxim's low-EMI modulation scheme with minimum pulse outputs when the audio inputs are at the zero crossing. As the input voltage increases or decreases, the duration of the pulse at one output increases while the other output pulse duration remains the same. This causes the net voltage across the speaker ($V_{\text{OUT}+} - V_{\text{OUT}-}$) to change. The minimum-width pulse topology reduces EMI and increases efficiency.

10W Mono Class D Speaker Amplifier with Volume Control

Operating Modes

Fixed-Frequency Mode

The MAX9768 features two fixed-frequency modes: 300kHz and 360kHz. Connect SYNC to GND to select 300kHz switching frequency; leave SYNC unconnected to select 360kHz switching frequency. The frequency spectrum of the MAX9768 consists of the fundamental switching frequency and its associated harmonics (see the Wideband Output Spectrum graphs in the *Typical Operating Characteristics*). For applications where exact spectrum placement of the switching fundamental is important, program the switching frequency so the harmonics do not fall within a sensitive frequency band (Table 1). Audio reproduction is not affected by changing the switching frequency.

Spread-Spectrum Mode

The MAX9768 features a unique, patented spread-spectrum mode that flattens the wideband spectral components, improving EMI emissions that may be radiated by the speaker and cables. This mode is enabled by setting SYNC = V_{DD} (Table 1). In SSM mode, the switching frequency varies randomly by ±7.5kHz around the center frequency (300kHz). The modulation scheme remains the same, but the period of the triangle waveform changes from cycle to cycle. Instead of a large amount of spectral energy present at multiples of the switching frequency, the energy is now spread over a bandwidth that increases with frequency. Above a few megahertz, the wideband spectrum looks like white noise for EMI purposes. A proprietary amplifier topology ensures this does not corrupt the noise floor in the audio bandwidth.

External Clock Mode

The SYNC input allows the MAX9768 to be synchronized to an external clock, or another Maxim Class D amplifier, creating a fully synchronous system, minimizing clock intermodulation, and allocating spectral components of the switching harmonics to insensitive

frequency bands. Applying a clock signal between 1MHz and 1.6MHz to SYNC synchronizes the MAX9768. The Class D switching frequency is equal to one-fourth the SYNC input frequency.

SYNCOUT is equal to the SYNC input frequency and allows several Maxim amplifiers to be cascaded. The synchronized output minimizes interference due to clock intermodulation caused by the switching spread between single devices. The modulation scheme remains the same when using SYNCOUT, and audio reproduction is not affected (Figure 1). Current flowing between SYNCOUT of a master device and SYNC of a slave device is low as the SYNC input is high impedance (typically 200kΩ).

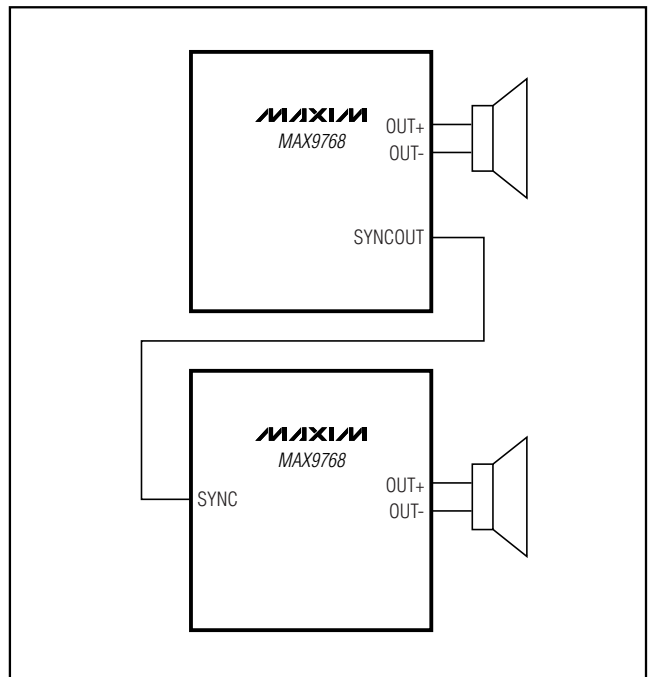

Figure 1. Cascading Two Amplifiers

Table 1. Operating Modes

SYNC	OSCILLATOR FREQUENCY (kHz)	CLASS D FREQUENCY (kHz)
GND	Fixed-frequency modulation with $f_{OSC} = 1200$	Fixed-frequency modulation with $f_{OSC} = 300$
Unconnected	Fixed-frequency modulation with $f_{OSC} = 1440$	Fixed-frequency modulation with $f_{OSC} = 360$
V _{DD}	Spread-spectrum modulation with $f_{OSC} = 1200 \pm 30$	Spread-spectrum modulation with $f_{OSC} = 300 \pm 7.5$
Clocked	Fixed-frequency modulation with $f_{OSC} = \text{external clock frequency}$	Fixed-frequency modulation with $f_{OSC} = \text{external clock frequency} / 4$

10W Mono Class D Speaker Amplifier with Volume Control

Filterless Modulation/PWM Modulation

The MAX9768 features two output modulation schemes: filterless modulation or classic PWM, selectable through SCLK when the device is in analog mode (ADDR2 and ADDR1 = GND, Table 2) or through the I²C interface (Table 7). Maxim's unique, filterless modulation scheme eliminates the LC filter required by traditional Class D amplifiers, reducing component count, conserving board space and system cost. Although the MAX9768 meets FCC and other EMI limits with a low-cost ferrite bead filter, many applications still may want to use a full LC-filtered output. If using a full LC filter, the performance is best with the MAX9768 configured for classic PWM output.

Switching between schemes while in normal operating mode with the I²C interface, the output is not click-and-pop protected. To have click-and-pop protection when switching between output schemes, the device must enter shutdown mode and be configured to the new output scheme before the startup sequence is terminated.

The startup time for the MAX9768 is typically 220ms. The startup time for the MAX9768B is typically 15ms.

Efficiency

Efficiency of a Class D amplifier is due to the switching operation of the output stage transistors. In a Class D amplifier, the output transistors act as current-steering switches and consume negligible additional power. Any power loss associated with the Class D output stage is mostly due to the I²R loss of the MOSFET on-resistance, and quiescent-current overhead.

The theoretical best efficiency of a linear amplifier is 78%, however, that efficiency is only exhibited at peak output power. Under normal operating levels (typical music reproduction levels), efficiency falls below 30%, whereas the MAX9768 still exhibits > 80% efficiencies under the same conditions (Figure 2).

Soft Current Limit

When the output current exceeds the soft current limit, 2A (typ), the MAX9768 enters a cycle-by-cycle current-limit mode. In soft current-limit mode, the output is clipped at 2A. When the output decreases so the output current falls below 2A, normal operation resumes. The effect of soft current limiting is a slight increase in distortion. Most applications will not enter soft current-limit mode unless the speaker or filter creates impedance nulls below 8Ω.

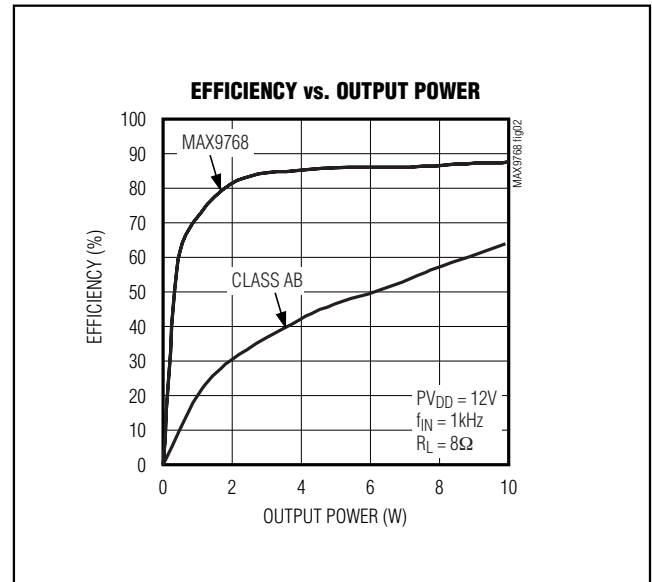

Figure 2. MAX9768 Efficiency vs. Class AB Efficiency

Table 2. Modulation Scheme Selection In Analog Mode

ADDR2	ADDR1	SDA/VOL	SCLK	FUNCTION
0	0	Analog Volume Control	0	Filterless Modulation
0	0	Analog Volume Control	1	Classic PWM (50% Duty Cycle)

10W Mono Class D Speaker Amplifier with Volume Control

Hard Current Limit

When the output current exceeds the hard current limit, 2.5A (typ), the MAX9768 disables the outputs and initiates a startup sequence. This startup sequence takes 220ms for the MAX9768 and 15ms for the MAX9768B. The shutdown and startup sequence is repeated until the output fault is removed. When in hard current limit, the output may make a soft clicking sound. The average supply current is relatively low, as the duty cycle of the output short is brief. Most applications will not enter hard current-limit mode unless the output is short circuited or incorrectly connected.

Thermal Shutdown

When the die temperature exceeds the thermal shutdown threshold, +150°C (typ), the MAX9768 outputs are disabled. When the die temperature decreases below +135°C (typ), normal operation resumes. The effect of thermal shutdown is an output signal turning off for approximately 3s in most applications, depending on the thermal time constant of the audio system. Most applications should never enter thermal shutdown. Some of the possible causes of thermal shutdown are too low of a load impedance, high ambient temperature, poor PCB layout and assembly, or excessive output overdrive.

Shutdown

The MAX9768 features a shutdown mode that reduces power consumption and extends battery life. Driving SHDN low places the device in low-power (0.5μA) shutdown mode. Connect SHDN to digital high for normal operation. In shutdown mode, the outputs are high impedance, SYNCOUT is pulled high, the BIAS voltage decays to zero, and the common-mode input voltage decays to zero. The I²C register retains its contents during shutdown.

Undervoltage Lockout (UVLO)

The MAX9768 features an undervoltage lockout protection that shuts down the device if either of the supplies are too low. The device will go into shutdown if V_{DD} is less than 2.5V (V_{DD} UVLO = 2.5V) or if PV_{DD} is less than 4V (PV_{DD} UVLO = 4V).

Mute Function

The MAX9768 features a clickless/popless mute mode. When the device is muted, the outputs do not stop switching, only the volume level is muted to the speaker. To mute the MAX9768, drive MUTE to logic-high.

MUTE should be held high during system power-up and power-down to ensure optimum click-and-pop performance.

Volume Control

The volume control operates from either an analog voltage input or through the I²C interface. The volume control has 64 levels, with the lowest setting equal to mute.

To set the device to analog mode, connect ADDR1 and ADDR2 to GND. In analog mode, SDA/VOL is an analog input for volume control, see the *Functional Diagram/Typical Application Circuit*. The analog input range is ratiometric between 0.9 x V_{DD} and 0.1 x V_{DD}, where 0.9 x V_{DD} = full mute and 0.1 x V_{DD} = full volume (Table 6).

In I²C mode, volume control for the speaker is controlled separately by the command register (Tables 4, 5, 6). See the *Write Data Format* section for more information regarding formatting data and tables to set volume levels.

I²C Interface

The MAX9768 features an I²C 2-wire serial interface consisting of a serial data line (SDA) and a serial clock line (SCL). SDA and SCL facilitate communication between the MAX9768 and the master at clock rates up to 400kHz. When the MAX9768 is used on an I²C bus with multiple devices, the V_{DD} supply must stay powered on to ensure proper I²C bus operation. The master, typically a microcontroller, generates SCL and initiates data transfer on the bus. Figure 3 shows the 2-wire interface timing diagram.

A master device communicates to the MAX9768 by transmitting the proper address followed by the data word. Each transmit sequence is framed by a START (S) or REPEATED START (S_r) condition and a STOP (P) condition. Each word transmitted over the bus is 8 bits long and is always followed by an acknowledge clock pulse.

The MAX9768 SDA line operates as both an input and an open-drain output. A pullup resistor, greater than 500Ω, is required on the SDA bus. The MAX9768 SCL line operates as an input only. A pullup resistor, greater than 500Ω, is required on SCL if there are multiple masters on the bus, or if the master in a single-master system has an open-drain SCL output. Series resistors in line with SDA and SCL are optional. The SCL and SDA inputs suppress noise spikes to assure proper device operation even on a noisy bus.

10W Mono Class D Speaker Amplifier with Volume Control

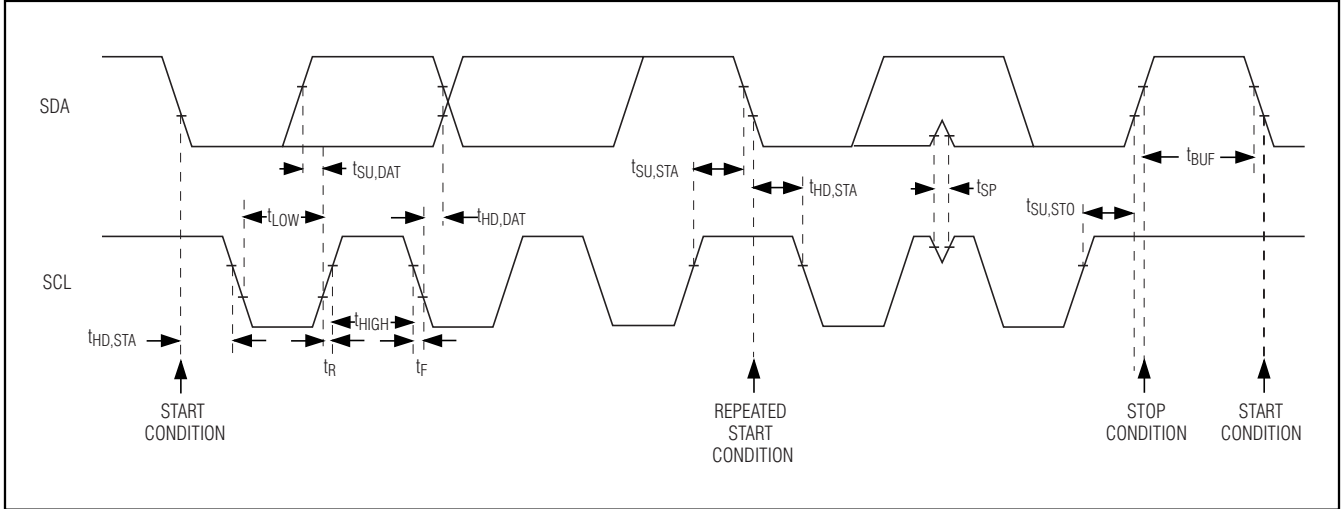

Figure 3. 2-Wire Serial-Interface Timing Diagram

Bit Transfer

One data bit is transferred during each SCL cycle. The data on SDA must remain stable during the high period of the SCL pulse. Changes in SDA while SCL is high are control signals (see the *START and STOP Conditions* section). SDA and SCL idle high when the I²C bus is not busy.

START and STOP Conditions

A master device initiates communication by issuing a START condition. A START condition is a high-to-low transition on SDA with SCL high. A STOP condition is a low-to-high transition on SDA while SCL is high (Figure 4). A START (S) condition from the master signals the beginning of a transmission to the MAX9768. The master terminates transmission, and frees the bus, by issuing a STOP (P) condition. The bus remains active if a REPEATED START (Sr) condition is generated instead of a STOP condition.

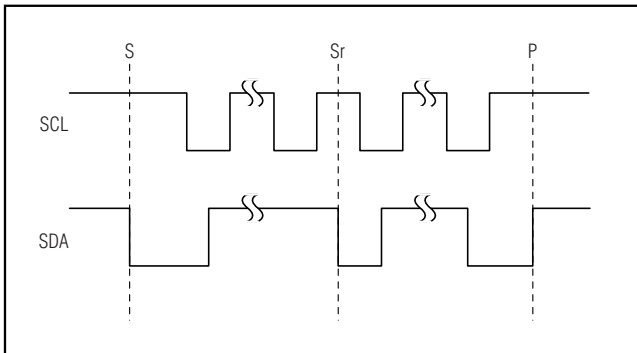

Figure 4. START, STOP, and REPEATED START Conditions

Early STOP Conditions

The MAX9768 recognizes a STOP condition at any point during data transmission except if the STOP condition occurs in the same high pulse as a START condition.

Slave Address

The slave address of the MAX9768 is 8 bits and consisting of 3 fields: the first field is 5 bits wide and is fixed (10010). The second is a 2-bit field, which is set through ADDR2 and ADDR1 (externally connected as logic-high or low). Third field is a R/W flag bit. Set R/W = 0 to write to the slave. A representation of the slave address is shown in Table 3.

When ADDR1 and ADDR2 are connected to GND, serial interface communication is disabled. Table 4 summarizes the slave address of the device as a function of ADDR1 and ADDR2.

Acknowledge

The acknowledge bit (ACK) is a clocked 9th bit that the MAX9768 uses to handshake receipt each byte of data (Figure 5). The MAX9768 pulls down SDA during the master-generated 9th clock pulse. The SDA line must remain stable and low during the high period of the acknowledge clock pulse. Monitoring ACK allows for detection of unsuccessful data transfers. An unsuccessful data transfer occurs if a receiving device is busy or if a system fault has occurred. In the event of an unsuccessful data transfer, the bus master can re-attempt communication.

10W Mono Class D Speaker Amplifier with Volume Control

Table 3. Slave Address Block

SA7 (MSB)	SA6	SA5	SA4	SA3	SA2	SA1	SA0 (LSB)
1	0	0	1	0	ADDR2	ADDR1	R/W

Table 4. Slave Address

ADDR2	ADDR1	SLAVE ADDRESS
0	0	Disabled
0	1	1001001_
1	0	1001010_
1	1	1001011_

Write Data Format

A write to the MAX9768 includes transmission of a START condition, the slave address with the R/W bit set to 0 (see Table 3), one byte of data to the command register, and a STOP condition. Figure 6 illustrates the proper format for one frame.

Volume Control

The command register is used to control the volume level of the speaker amplifier. The two MSBs (D7 and D6) should be set to 00 to choose the speaker register. V5–V0 is the volume control data that will be written into the addresses register to set the volume level (see Tables 5 and 6).

For a write byte operation, the master sends a single byte to the slave device (MAX9768). This is done as follows:

- 1) The master sends a start condition.
- 2) The master sends the 7-bit slave ID plus a write bit (low).
- 3) The addressed slave asserts an ACK on the data line.
- 4) The master sends 8 data bits.
- 5) The active slave asserts an ACK (or NACK) on the data line.
- 6) The master generates a stop condition.

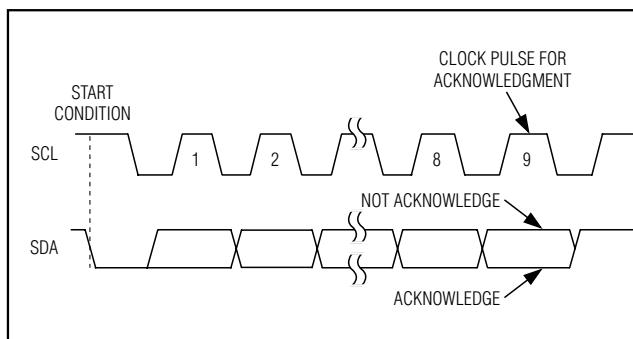

Figure 5. Acknowledge

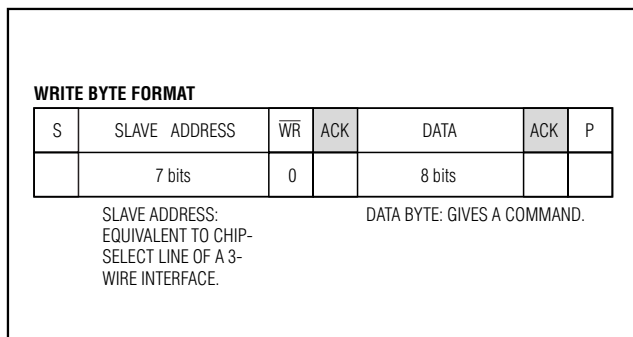

Figure 6. Write Data Format Example

10W Mono Class D Speaker Amplifier with Volume Control

Table 5. Data Byte Format

D7 (MSB)	D6	D5	D4	D3	D2	D1	D0 (LSB)
0	0	V5	V4	V3	V2	V1	V0

Table 6. Speaker Volume Levels

V5	V4	V3	V2	V1	V0	VOLUME POSITION	VOLUME LEVEL (dB)	STEP SIZE (dB)
1	1	1	1	1	1	63	9.5	0.7
1	1	1	1	1	0	62	8.8	0.7
1	1	1	1	0	1	61	8.2	0.6
1	1	1	1	0	0	60	7.6	0.6
1	1	1	0	1	1	59	7.0	0.6
1	1	1	0	1	0	58	6.5	0.5
1	1	1	0	0	1	57	5.9	0.5
1	1	1	0	0	0	56	5.4	0.5
1	1	0	1	1	1	55	4.9	0.5
1	1	0	1	1	0	54	4.4	0.5
1	1	0	1	0	1	53	3.9	0.6
1	1	0	1	0	0	52	3.4	0.4
1	1	0	0	1	1	51	2.9	0.5
1	1	0	0	1	0	50	2.4	0.4
1	1	0	0	0	1	49	2.0	0.4
1	1	0	0	0	0	48	1.6	0.4
1	0	1	1	1	1	47	1.2	0.7
1	0	1	1	1	0	46	0.5	1.0
1	0	1	1	0	1	45	-0.5	1.5
1	0	1	1	0	0	44	-1.9	1.5
1	0	1	0	1	1	43	-3.4	1.5
1	0	1	0	1	0	42	-5.0	1.1
1	0	1	0	0	1	41	-6.0	1.1
1	0	1	0	0	0	40	-7.1	1.8
1	0	0	1	1	1	39	-8.9	1.0
1	0	0	1	1	0	38	-9.9	1.0
1	0	0	1	0	1	37	-10.9	1.1
1	0	0	1	0	0	36	-12.0	1.2
1	0	0	0	1	1	35	-13.1	1.3
1	0	0	0	1	0	34	-14.4	0.9
1	0	0	0	0	1	33	-15.4	1.0
1	0	0	0	0	0	32	-16.4	1.1

10W Mono Class D Speaker Amplifier with Volume Control

MAX9768

Table 6. Speaker Volume Levels (continued)

V5	V4	V3	V2	V1	V0	VOLUME POSITION	VOLUME LEVEL (dB)	STEP SIZE (dB)
0	1	1	1	1	1	31	-17.5	2.2
0	1	1	1	1	0	30	-19.7	1.9
0	1	1	1	0	1	29	-21.6	1.9
0	1	1	1	0	0	28	-23.5	1.7
0	1	1	0	1	1	27	-25.2	2.0
0	1	1	0	1	0	26	-27.2	2.6
0	1	1	0	0	1	25	-29.8	1.6
0	1	1	0	0	0	24	-31.5	2.0
0	1	0	1	1	1	23	-33.4	2.5
0	1	0	1	1	0	22	-36.0	1.6
0	1	0	1	0	1	21	-37.6	2.0
0	1	0	1	0	0	20	-39.6	2.5
0	1	0	0	1	1	19	-42.1	1.6
0	1	0	0	1	0	18	-43.7	2.0
0	1	0	0	0	1	17	-45.6	2.5
0	1	0	0	0	0	16	-48.1	2.5
0	0	1	1	1	1	15	-50.6	3.5
0	0	1	1	1	0	14	-54.2	2.5
0	0	1	1	0	1	13	-56.7	3.5
0	0	1	1	0	0	12	-60.2	2.5
0	0	1	0	1	1	11	-62.7	3.5
0	0	1	0	1	0	10	-66.2	2.5
0	0	1	0	0	1	9	-68.7	3.5
0	0	1	0	0	0	8	-72.2	2.5
0	0	0	1	1	1	7	-74.7	3.5
0	0	0	1	1	0	6	-78.3	2.5
0	0	0	1	0	1	5	-80.8	3.5
0	0	0	1	0	0	4	-84.3	2.5
0	0	0	0	1	1	3	-86.8	3.5
0	0	0	0	1	0	2	-90.3	2.5
0	0	0	0	0	1	1	-92.8	—
0	0	0	0	0	0	0 (MUTE)	-161.5	—

10W Mono Class D Speaker Amplifier with Volume Control

Applications Information

Filterless Class D Operation

The MAX9768 can be operated without a filter and meet common EMC radiation limits when the speaker leads are less than approximately 10cm. Lengths beyond 10cm are possible but should be verified against the appropriate EMC standard. Select the filterless modulation mode with spread-spectrum modulation mode for best performance.

For longer speaker wire lengths, a simple ferrite bead and capacitor-based filter can be used to meet EMC

limits. See Figure 7 for the correct connections of these components. Select a ferrite bead with 100Ω to 600Ω impedance, and rated for at least 1.5A. The capacitor value will vary based on the ferrite bead chosen and the actual speaker lead length. Select the capacitor value based on EMC performance.

When doing bench evaluation without a filter or a ferrite bead filter, include a series inductor (68μH for 8Ω load) to model the actual loudspeaker's behavior. If this inductance is omitted, the MAX9768 will have reduced efficiency and output power, as well as worse THD+N performance.

Table 7. Setting Class D Output Modulation Scheme

D7 (MSB)	D6	D5	D4	D3	D2	D1	D0 (LSB)	FUNCTION
1	1	0	1	0	1	0	1	Classic PWM
1	1	0	1	0	1	1	0	FILTERLESS MODULATION*

*Power-on default.

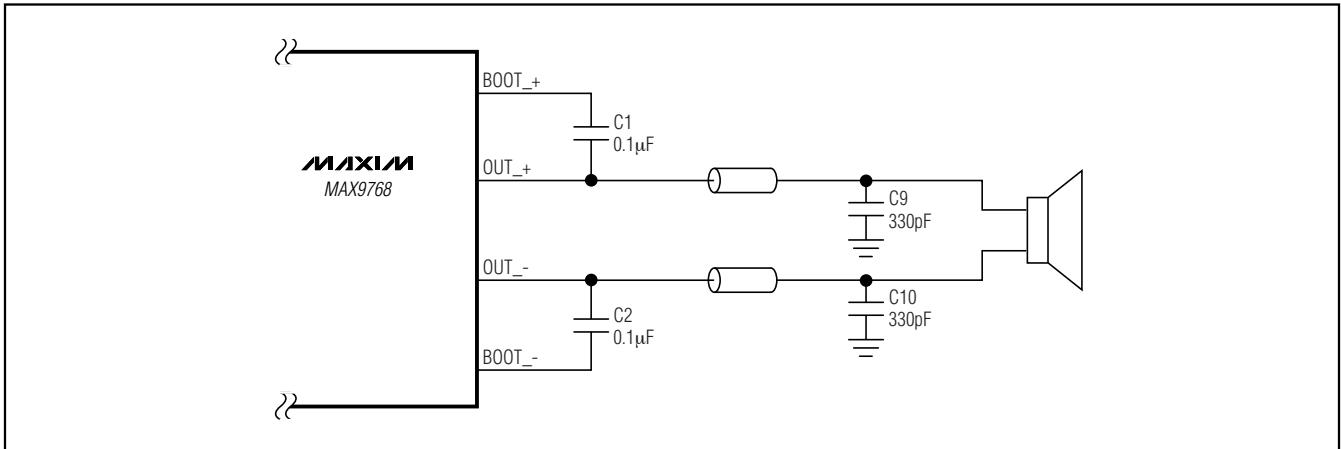

Figure 7. Ferrite Bead Filter

10W Mono Class D Speaker Amplifier with Volume Control

Inductor-Based Output Filters

Some applications will use the MAX9768 with a full inductor-/capacitor-based (LC) output filter. This is common for longer speaker lead lengths, and to gain increased margin to EMC limits. Select the PWM output mode and use fixed-frequency modulation mode for best audio performance. See Figure 8 for the correct connections of these components.

The component selection is based on the load impedance of the speaker. Table 8 lists suggested values for a variety of load impedances.

Inductors L3 and L4, and capacitor C15 form the primary output filter. In addition to these primary filter components, other components in the filter improve its functionality. Capacitors C13 and C14, plus resistors R6 and R7, form a Zobel at the output. A Zobel corrects the output loading to compensate for the rising impedance of the loudspeaker. Without a Zobel, the filter will have a peak in its response near the cutoff frequency. Capacitors C11 and C12 provide additional high-frequency bypass to reduce radiated emissions.

Adjustable Gain

Gain-Setting Resistors

External feedback resistors set the gain of the MAX9768. The output stage has an internal 20dB gain in addition to the externally set gain. Set the maximum gain by using resistors R_F and R_{IN} (Figure 9) as follows:

$$A_V = -10 \left(\frac{R_F}{R_{IN}} \right) \text{ V/V}$$

Choose R_F between 10kΩ and 50kΩ. Please note that the actual gain of the amplifier is dependent on the volume level setting. For example, with the volume control set to +9.5dB, the amplifier gain would be 9.5dB + 20dB, assuming R_F = R_{IN}.

The input amplifier can be configured into a variety of circuits. The FB terminal is an actual operational amplifier output, allowing the MAX9768 to be configured as a summing amplifier, a filter, or an equalizer, for example.

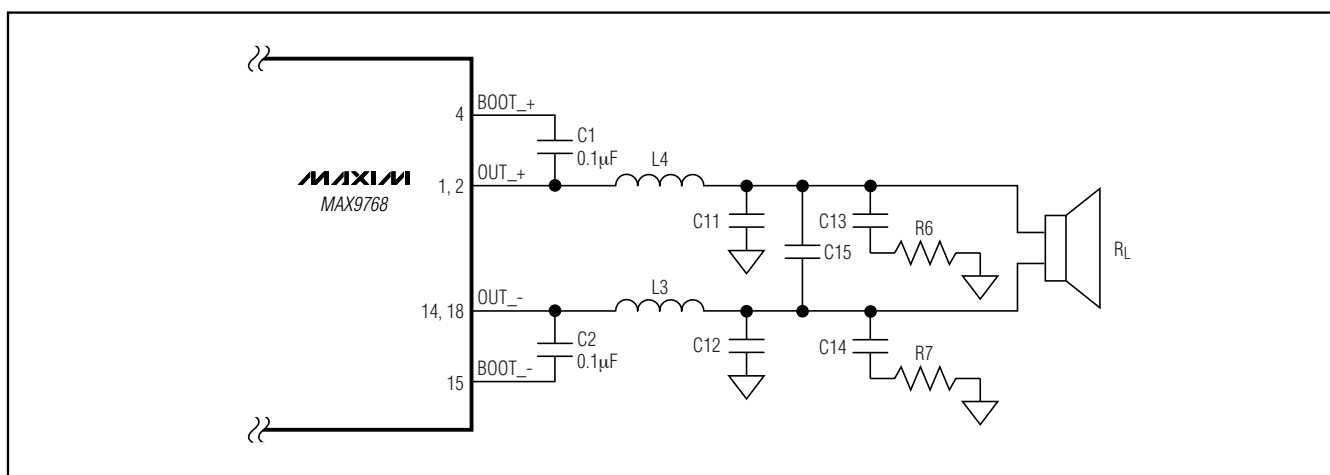

Figure 8. Output Filter for PWM Mode

Table 8. Suggested Values for LC filter

R _L (Ω)	L3, L4 (µH)	C15 (µF)	C11, C12 (µF)	R6, R7 (Ω)	C13, C14 (µF)
6	15	0.33	0.01	7.5	0.68
8	22	0.22	0.01	10	0.47
12	33	0.1	0.01	15	0.33

10W Mono Class D Speaker Amplifier with Volume Control

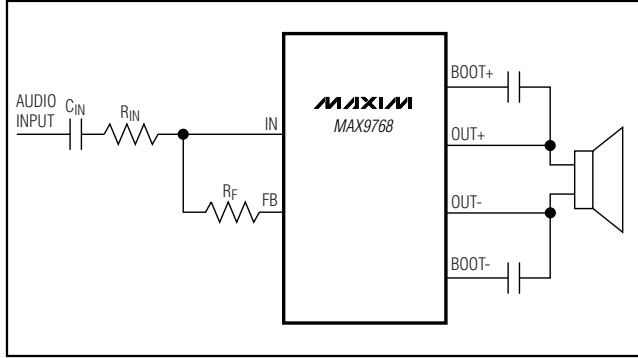

Figure 9. Setting Gain

Power Supplies

The MAX9768 has different supplies for each portion of the device, allowing for the optimum combination of headroom power dissipation and noise immunity. The speaker amplifiers are powered from PV_{DD} and can range from 4.5V to 14V. The remainder of the device is powered by V_{DD}. Power supplies are independent of each other so sequencing is not necessary. Power may be supplied by separate sources or derived from a single higher source using a linear regulator to reduce the voltage as shown in Figure 10.

Component Selection

Input Filter

An input capacitor, C_{IN}, in conjunction with the input resistor of the MAX9768 forms a highpass filter that removes the DC bias from an incoming signal. The AC-coupling capacitor allows the amplifier to automatically bias the signal to an optimum DC level. Assuming zero source impedance, the -3dB point of the highpass filter is given by:

$$f_{-3dB} = \frac{1}{2\pi R_{IN} C_{IN}}$$

Choose C_{IN} so f_{-3dB} is well below the lowest frequency of interest. Use capacitors whose dielectrics have low-voltage coefficients, such as tantalum or aluminum electrolytic. Capacitors with high-voltage coefficients, such as ceramics, may result in increased distortion at low frequencies.

Other considerations when designing the input filter include the constraints of the overall system and the actual frequency band of interest. Although high-fidelity audio calls for a flat-gain response between 20Hz and 20kHz, portable voice-reproduction devices such as cellular phones and two-way radios need only concentrate

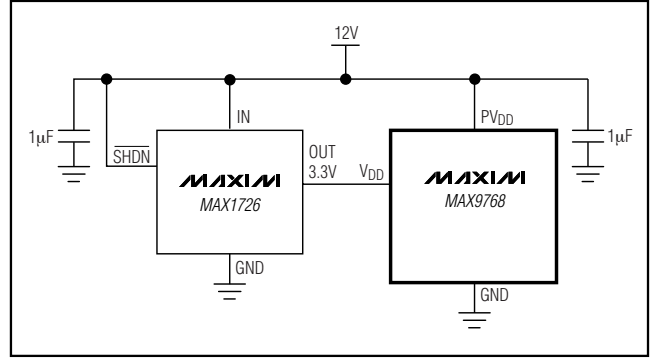

Figure 10. Using a Linear Regulator to Produce 3.3V from a 12V Power Supply

on the frequency range of the spoken human voice (typically 300Hz to 3.5kHz). In addition, speakers used in portable devices typically have a poor response below 300Hz. Taking these two factors into consideration, the input filter may not need to be designed for a 20Hz to 20kHz response, saving both board space and cost due to the use of smaller capacitors.

BIAS Capacitor

BIAS is the output of the internally generated DC bias voltage. The BIAS bypass capacitor, C_{BIAS}, improves PSRR and THD+N by reducing power supply and other noise sources at the common-mode bias node. Bypass BIAS with a 2.2µF capacitor to GND.

Supply Bypassing, Layout, and Grounding

Proper layout and grounding are essential for optimum performance. Use large traces for the power-supply inputs and amplifier outputs to minimize losses due to parasitic trace resistance. Large traces also aid in moving heat away from the package. Proper grounding improves audio performance, minimizes crosstalk between channels, and prevents any switching noise from coupling into the audio signal. Connect PGND and GND together at a single point on the PCB. Route all traces that carry switching transients away from GND and the traces/components in the audio signal path.

Bypass V_{DD} and PV_{DD} with a 1µF capacitor to PGND. Place the bypass capacitors as close to the MAX9768 as possible. Place a bulk capacitor between PV_{DD} and PGND, if needed.

Use large, low-resistance output traces. Current drawn from the outputs increase as load impedance decreases. High output trace resistance decreases the power delivered to the load. Large output, supply, and GND traces allow more heat to move from the MAX9768 to the air, decreasing the thermal impedance of the circuit if possible.

10W Mono Class D Speaker Amplifier with Volume Control

Pin Configuration

Chip Information

PROCESS: BICMOS

MAX9768

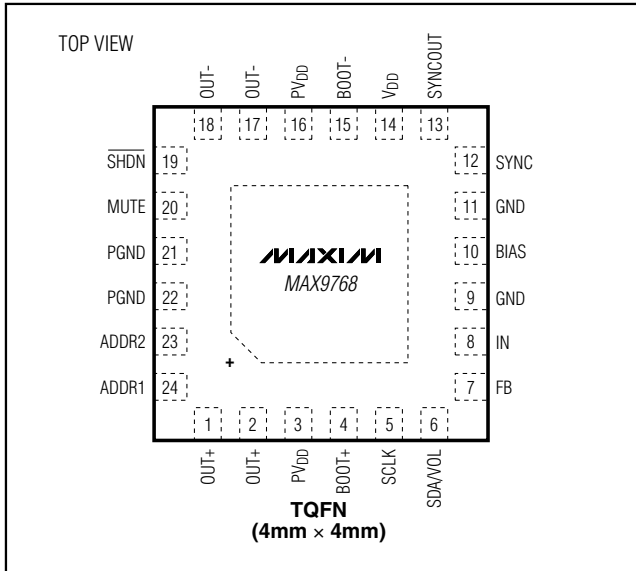

10W Mono Class D Speaker Amplifier with Volume Control

Package Information

(The package drawing(s) in this data sheet may not reflect the most current specifications. For the latest package outline information, go to www.maxim-ic.com/packages.)

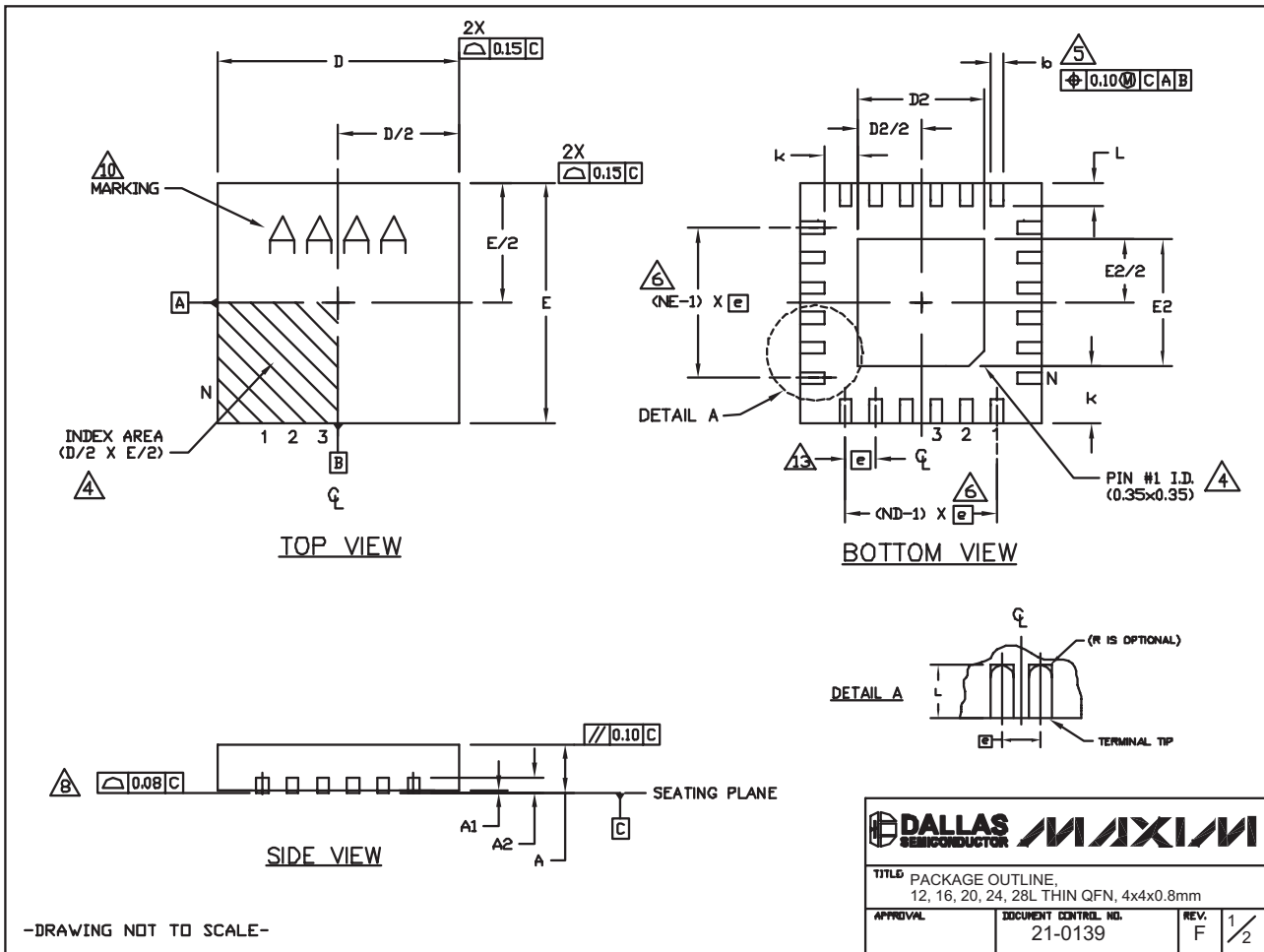

DALLAS SEMICONDUCTOR		MAXIM	
TITLE PACKAGE OUTLINE, 12, 16, 20, 24, 28L THIN QFN, 4x4x0.8mm			
APPROVAL	DOCUMENT CONTROL NO. 21-0139	REV. F	1/2

10W Mono Class D Speaker Amplifier with Volume Control

Package Information (continued)

(The package drawing(s) in this data sheet may not reflect the most current specifications. For the latest package outline information, go to www.maxim-ic.com/packages.)

MAX9768

24L QFN THIN.EPS

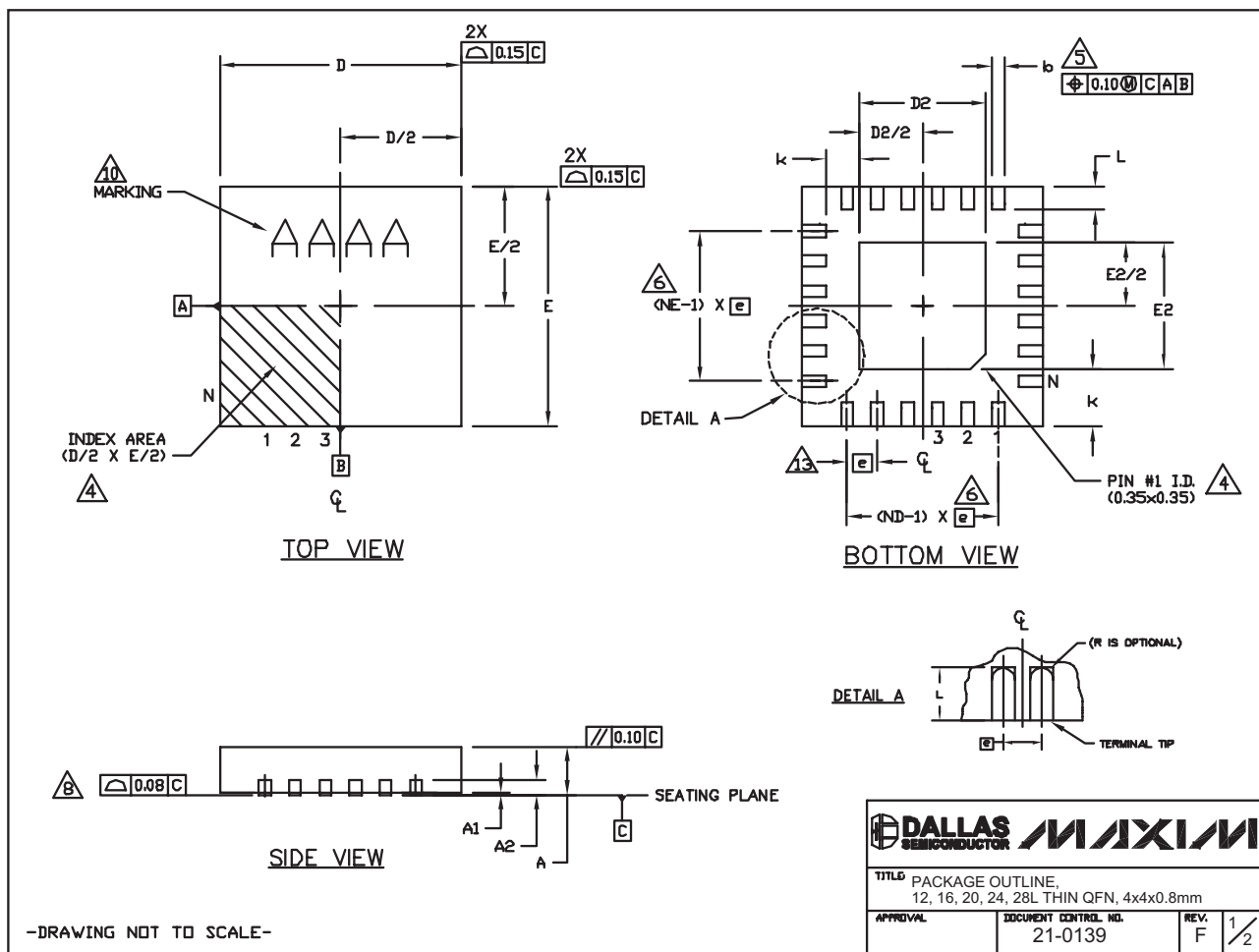

-DRAWING NOT TO SCALE-

Maxim cannot assume responsibility for use of any circuitry other than circuitry entirely embodied in a Maxim product. No circuit patent licenses are implied. Maxim reserves the right to change the circuitry and specifications without notice at any time.

Maxim Integrated Products, 120 San Gabriel Drive, Sunnyvale, CA 94086 408-737-7600 25