

Bidirectional ESD / Transient Suppressor

CPD Series (RoHS Device)



Features

- (16kV) IEC 61000-4-2 rating
- Surface mount package
- High component density

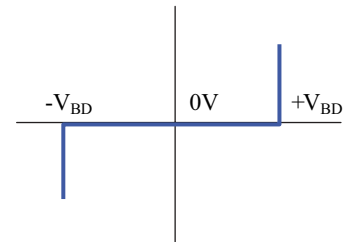
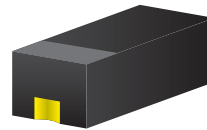

Applications

- ESD suppression
- Transient suppression
- Automotive CAN Bus

Circuit Schematic

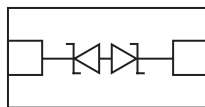

Package

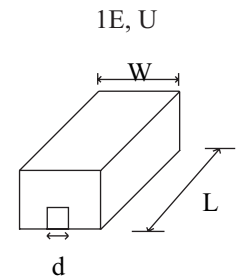
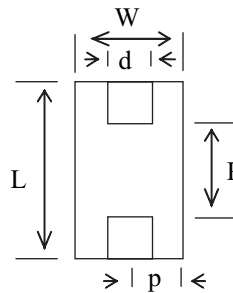

Dimensions in (mm):

Package Code	Package Power	Number of Pins	L ± 0.2	W ± 0.2	p ± 0.1	P ± 0.1	Pkg. Height ± 0.2	d ± 0.1
1E	100mw	2	1.1 (.05)	0.75 (.030)	.38 (.015)	0.33 (.013)	.75 (.030)	.35 (.014)
U	100mw	2	1.6 (.063)	0.8 (.031)	0.4 (.016)	0.5 (.020)	0.75 (.030)	0.6 (.024)

Application Schematic

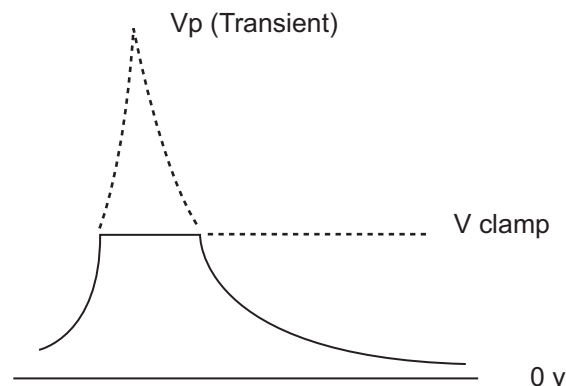
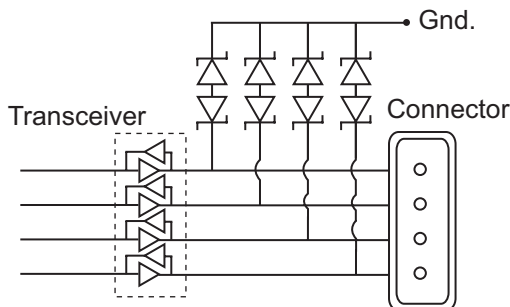

Bidirectional ESD Suppressor



Specifications:(Ta = 25°C)

36V Characteristic PRELIMINARY

Symbol	Characteristic	Min	Typ	Max	Units	Test Condition
V _{BD}	Diode breakdown voltage	38	40		V	I _F = 1 ma
I _L	Leakage current		0.1	2.0	uA	36v
C _T	Capacitance		5		pF	@ 1Mhz
V _{ESD}	Channel clamp voltage		-	+ 40	V	8kV event
V _{PV}	Peak ESD voltage capability			16	kV	IEC 61000-4-2
I _{pp} *	Peak Pulse Current			15	A	8 / 20 us

24V Characteristic (CAN bus)

Symbol	Characteristic	Min	Typ	Max	Units	Test Condition
V _{BD}	Diode breakdown voltage	25	28		V	I _F = 1 ma
I _L	Leakage current		0.1	2.0	uA	24v
C _T	Capacitance		10		pF	@ 1Mhz
V _{ESD}	Channel clamp voltage		-	+ 25	V	8kV event
V _{PV}	Peak ESD voltage capability			16	kV	IEC 61000-4-2
I _{pp} *	Peak Pulse Current			15	A	8 / 20 us

12V Characteristic PRELIMINARY

Symbol	Characteristic	Min	Typ	Max	Units	Test Condition
V _{BD}	Diode breakdown voltage	14	17		V	I _F = 1 ma
I _L	Leakage current		0.1	2.0	uA	12v
C _T	Capacitance		12		pF	@ 1Mhz
V _{ESD}	Channel clamp voltage		-	+ 17	V	8kV event
V _{PV}	Peak ESD voltage capability			16	kV	IEC 61000-4-2
I _{pp} *	Peak Pulse Current			15	A	8 / 20 us

5V0 Characteristic

Symbol	Characteristic	Min	Typ	Max	Units	Test Condition
V _{BD}	Diode breakdown voltage	5.1	7.0		V	I _F = 1 ma
I _L	Leakage current		+0.1	+ 2.0	uA	5v
C _T	Capacitance		15	20	pF	@ 1Mhz
V _{ESD}	Channel clamp voltage		-	+ 7.0	V	8kV event
V _{PV}	Peak ESD voltage capability			16	kV	IEC 61000-4-2
I _{pp} *	Peak Pulse Current			5.1	A	8 / 20 us

* one diode conducting

Ordering Information:

Type	Package Code	Voltage
CPD	Code from Dimensions Table	5V0 12V 24V 36V