

High Reliability Series Serial EEPROMs

WL-CSP EEPROM family

I²C BUS



BU9833GUL-W

No.10001EAT17

●Description

BU9833GUL-W series is a serial EEPROM of I²C BUS interface method. 1.7V single power source action and actions available at 400kHz.

●Features

- 1) Completely conforming to the world standard I²C BUS. All controls available by 2 ports of serial clock (SCL) and serial data(SDA)
- 2) Other devices than EEPROM can be connected to the same port, saving microcontroller port.
- 3) Actions available at 400kHz clock (1.7V~5.5V)
- 4) 1.7~5.5V single power source action most suitable for battery use.
- 5) Page write mode useful for initial value write at factory shipment.
- 6) Auto erase and auto end function at data rewrite.
- 7) Low current consumption
 - At write action (5V) : 1.2mA (Typ.)
 - At read action (5V) : 0.2mA (Typ.)
 - At standby action (5V) : 0.1μA (Typ.)
- 8) Write mistake prevention function
 - Write (write protect) function added.
 - Write mistake prevention function at low voltage.
- 9) Data rewrite up to 1,000,000times.
- 10) Data kept for 40 years.
- 11) Noise filter built in SCL / SDA terminal
- 12) Shipment data all address FFh.

●Page write

Product number	Number of pages
BU9833GUL-W	16Byte

●BU9833GUL-W

Type	Capacity	Bit format	Power source voltage	Package
BU9833GUL-W	2Kbit	256×8	1.7~5.5V	VCSP50L1

●Absolute maximum ratings (Ta=25°C)

Parameter	Symbol	Ratings	Unit
Impressed voltage	Vcc	-0.3~+6.5 ^{*1}	V
Permissible dissipation	Pd	220	mW
Storage temperature range	Tstg	-65~125	°C
Operating temperature range	Topr	-40~85	°C
Terminal voltage	-	-0.3~Vcc+1.0	V

* When using at Ta=25°C or higher, 2.2mW (*1) to be reduced per 1°C

●Recommended action conditions

Parameter	Symbol	Ratings	Unit
Power source voltage	V _{CC}	1.7~5.5	V
Input voltage	V _{IN}	0~V _{CC}	

●Memory cell characteristics (T_a=25°C, V_{CC}=1.7~5.5V)

Parameter	Limits			Unit
	Min	Typ.	Max	
Number of data rewrite times *1	1,000,000	-	-	Times
Data hold years *1	40	-	-	Years

*1:Not 100% TESTED

●Electrical characteristics

(Unless otherwise specified, T_a=-40~+85°C, V_{CC}=1.7~5.5V)

Parameter	Symbol	Limits			Unit	Conditions
		Min.	Typ.	Max.		
"HIGH" input voltage1	V _{IH1}	0.7V _{CC}	-	V _{CC} +1.0	V	2.5V ≤ V _{CC} ≤ 5.5V
"LOW" Input voltage1	V _{IL1}	-0.3	-	0.3V _{CC}	V	2.5V ≤ V _{CC} ≤ 5.5V
"HIGH" input voltage2	V _{IH2}	0.8V _{CC}	-	V _{CC} +1.0	V	1.8V ≤ V _{CC} < 2.5V
"LOW" input voltage2	V _{IL2}	-0.3	-	0.2V _{CC}	V	1.8V ≤ V _{CC} < 2.5V
"HIGH" input voltage3	V _{IH3}	0.9V _{CC}	-	V _{CC} +1.0	V	1.7V ≤ V _{CC} < 1.8V
"LOW" input voltage3	V _{IL3}	-0.3	-	0.1V _{CC}	V	1.7V ≤ V _{CC} < 1.8V
"LOW" output voltage1	V _{OL1}	-	-	0.4	V	I _{OL} =3.0mA, 2.5V ≤ V _{CC} ≤ 5.5V, (SDA)
"LOW" output voltage2	V _{OL2}	-	-	0.2	V	I _{OL} =0.7mA, 1.7V ≤ V _{CC} < 2.5V, (SDA)
Input leak current	I _{LI}	-1	-	1	μA	V _{IN} =0V~V _{CC}
Output leak current	I _{LO}	-1	-	1	μA	V _{OUT} =0V~V _{CC} (SDA)
Current consumption at action	I _{CC1}	-	-	2.0	mA	V _{CC} =5.5V, f _{SCL} =400kHz, t _{WR} =5ms, Byte write, Page write
	I _{CC2}	-	-	0.5	mA	V _{CC} =5.5V, f _{SCL} =400kHz Random read, vurrent read, sequential read
Standby current	I _{SB}	-	-	2.0	μA	V _{CC} =5.5V, SDA·SCL=V _{CC} , A2=GND, WP=GND

○This product is not designed for protection against radioactive rays.

●Action timing Characteristics

(Unless otherwise specified, Ta=-40~+85°C, Vcc=1.7~5.5V)

Parameter	Symbol	FAST-MODE 2.5V ≤ Vcc ≤ 5.5V			STANDARD-MODE 2.5V ≤ Vcc ≤ 5.5V			Unit
		Min.	Typ.	Max.	Min.	Typ.	Max.	
SCL frequency	fSCL	-	-	400	-	-	100	kHz
Data clock "HIGH" time	tHIGH	0.6	-	-	4.0	-	-	μs
Data clock "LOW" time	tLOW	1.2	-	-	4.7	-	-	μs
SDA, SCL rise time *1	tR *1	-	-	0.3	-	-	1.0	μs
SDA < SCL fall time *1	tF *1	-	-	0.3	-	-	0.3	μs
Start condition hold time	tHD:STA	0.6	-	-	4.0	-	-	μs
Start condition setup time	tSU:STA	0.6	-	-	4.7	-	-	μs
Input data hold time	tHD:DAT	0	-	-	0	-	-	ns
Input data setup time	tSU:DAT	100	-	-	250	-	-	ns
Output data delay time	tPD	0.1	-	0.9	0.2	-	3.5	μs
Output data hold time	tDH	0.1	-	-	0.2	-	-	μs
Stop condition setup time	tSU:STO	0.6	-	-	4.7	-	-	μs
Bus release time before transfer start	tBUF	1.2	-	-	4.7	-	-	μs
Internal write cycle time	tWR	-	-	5	-	-	5	ms
Noise removal valid period (SDA, SCL terminal)	tl	-	-	0.1	-	-	0.1	μs
WP hold time	tHD:WP	0	-	-	0	-	-	ns
WP setup time	tSU:WP	0.1	-	-	0.1	-	-	μs
WP valid time	tHIGH:WP	1.0	-	-	1.0	-	-	μs

*1 Not 100% tested.

●Sync data input / output timing

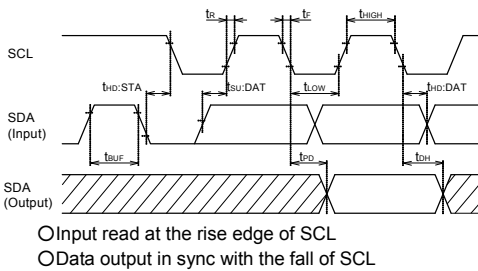

Fig.1(a) Sync data input / output timing

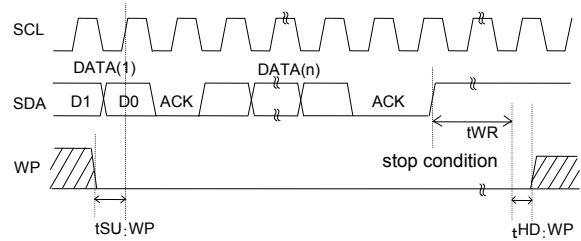

fig.1-(d) WP timing at write execution

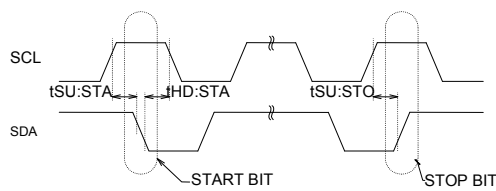

Fig.1-(b) Start – stop bit timing

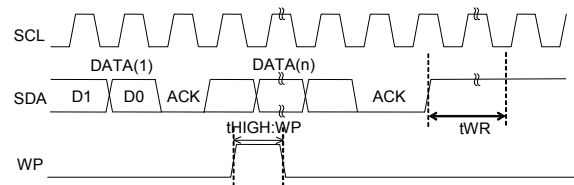

Fig.1-(e) WP timing at write cancel

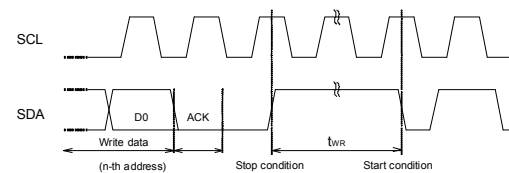

Fig.1-(c) Write cycle timing

○At write execution, in the area from the DO taken clock rise of the first DATA (1), to tWR, set WP="LOW"
○By setting WP "HIGH" in the area, write can be cancelled.
When it is set WP="HIGH" during tWR, write is forcibly ended, and data of address under access is not guaranteed, therefore write it once again.

●Block diagram

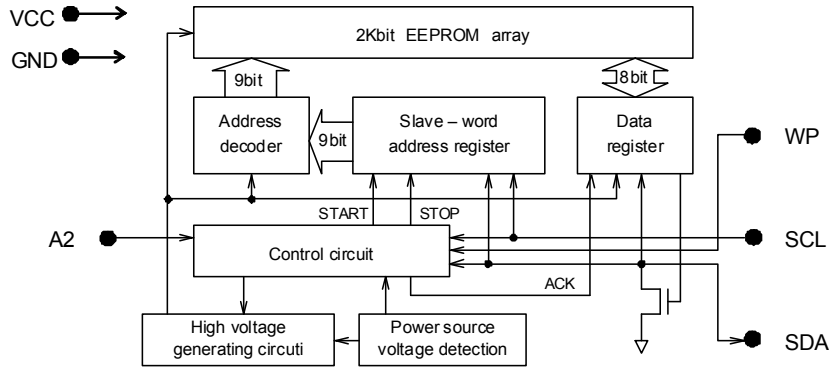

Fig.2 Block diagram

●Pin assignment and description

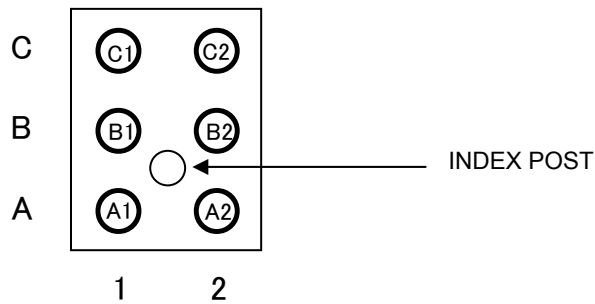

Fig.3 BU9833GUL-W (bottom view)

Land No.	Terminal name	Input/ Output	Function
C2	VCC	-	Power Supply
C1	A2	IN	Slave Address Set
B2	WP	IN	Write Protect Input
B1	GND	-	Ground (0V)
A2	SCL	IN	Serial Clock Input
A1	SDA	IN/OUT	Slave and Word Address, Serial Data Input, Serial Data Output *1

*1 An open drain output requires a pull-up resistor.

●Characteristic data (The following values are Typ. ones.)

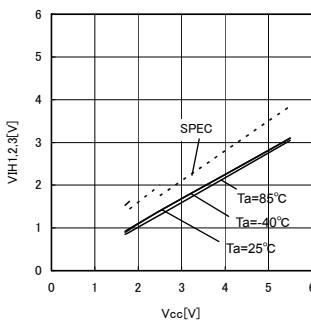

Fig.4 H input voltage VIH1,2,3 (A2,SCL,SDA,WP)

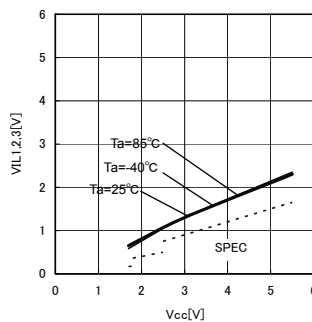

Fig.5 L input voltage VIL1,2,3 (A2,SCL,SDA,WP)

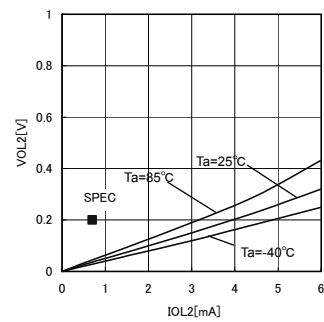

Fig.6 L output voltage VOL2-IOL2 (Vcc=1.7V)

●Characteristic data

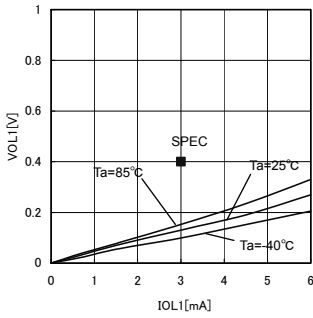

Fig. 7 L input voltage VOL1-IOL1 (Vcc=2.5V)

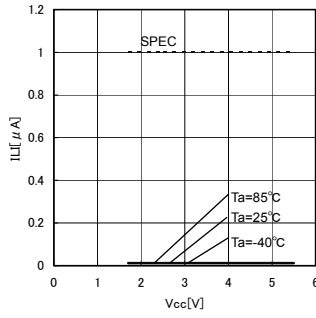

Fig. 8 Input leak current ILI (A2, SCL, WP)

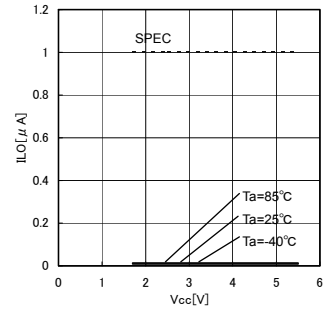

Fig. 9 Output leak current ILO (SDA)

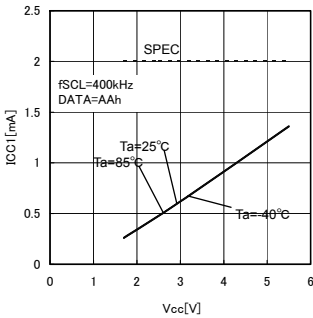

Fig. 10 Consumption current at write action Icc1 (fscl=400kHz)

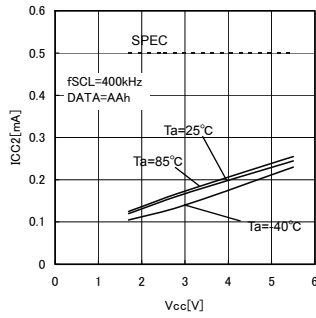

Fig. 11 Consumption current at write action Icc2 (fscl=400kHz)

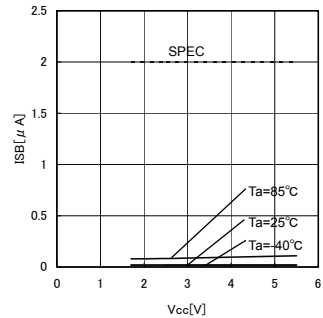

Fig. 12 Standby current ISB

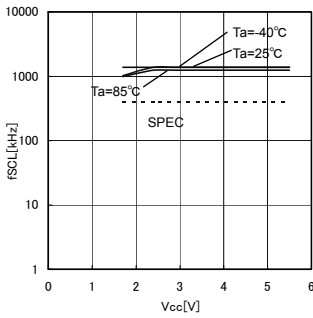

Fig. 13 SCL frequency fscl

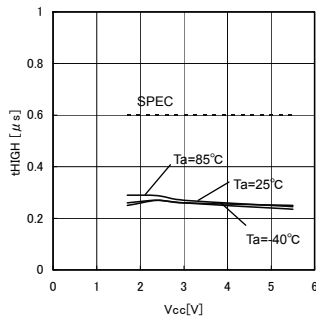

Fig. 14 Data clock "H" time tHIGH

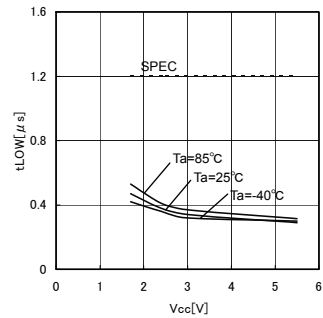

Fig. 15 Data clock "L" time tLOW

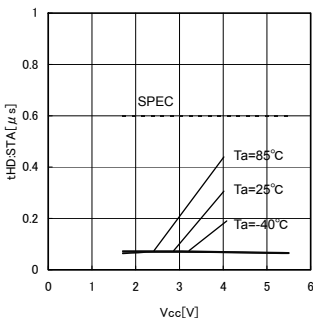

Fig. 16 Start condition hold time tHD:STA

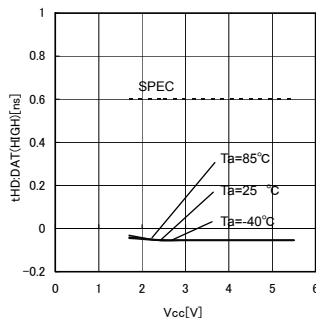

Fig. 17 Start condition setup time tSU:STA

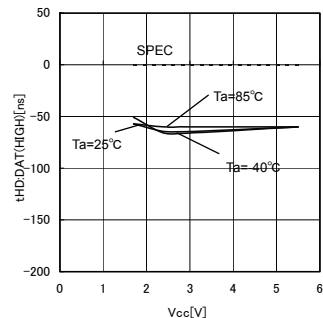

Fig. 18 Input data hold time tHD:DAT

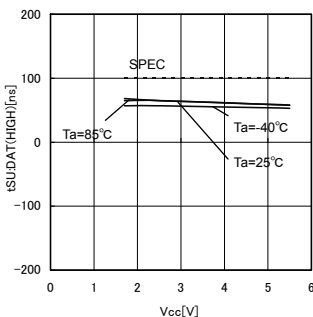

Fig. 19 Input data setup time tSU:DAT

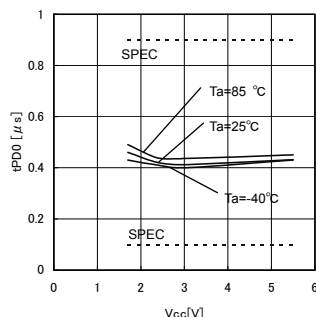

Fig. 20 Output data delay time tPD0

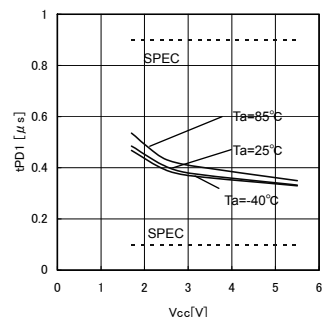

Fig. 21 Output data delay time tPD1

●Characteristic data

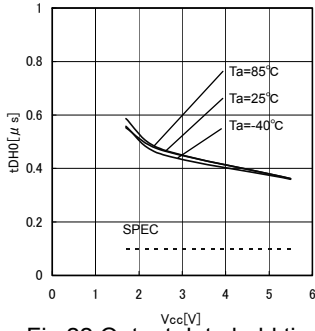

Fig.22 Output data hold time tDH1

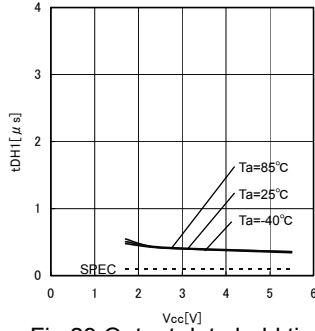

Fig.23 Output data hold time tDH1

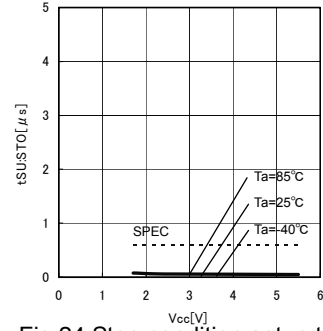

Fig.24 Stop condition setup time tSU:STO

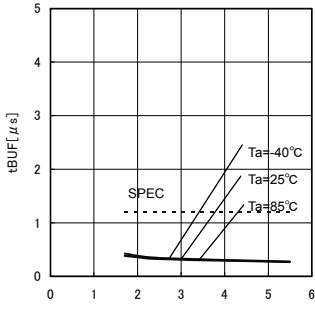

Fig.25 Bus release time before transfer start tBUF

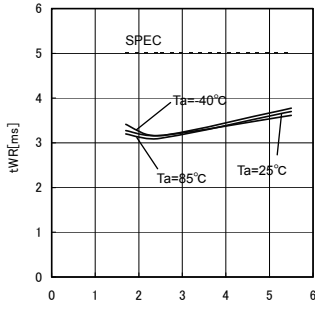

Fig.26 Internal write cycle time tWR

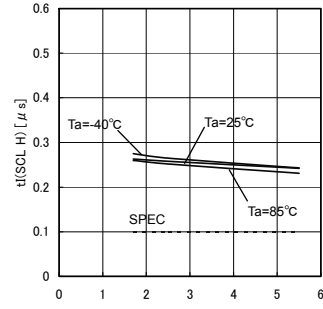

Fig.27 Noise removal time tl(SCL H)

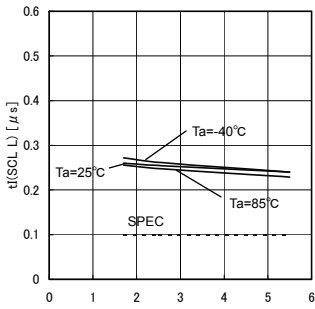

Fig.28 Noise removal time tl(SCL L)

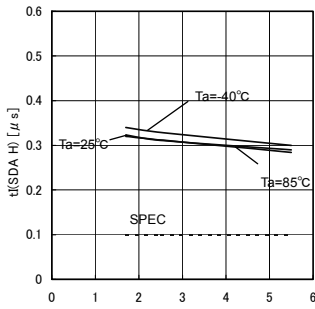

Fig.29 Noise removal time tl(SDA H)

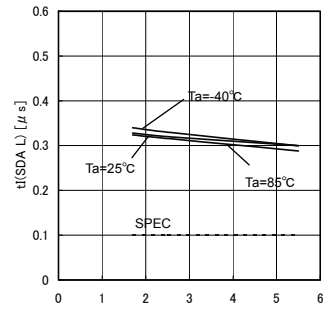

Fig.30 Noise removal time tl(SDA L)

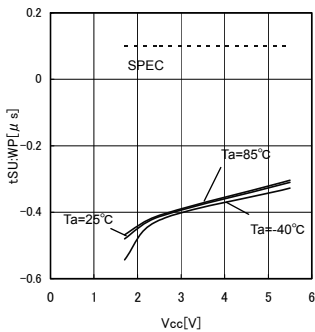

Fig.31 WP setup time tSU:WP

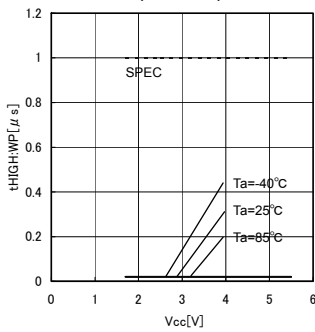

Fig.32 WP valid time tHIGH:WP

● I²C BUS communication

○ I²C BUS data communication

I²C BUS data communication starts by start condition input, and ends by stop condition input. Data is always 8bit long, and acknowledge is always required after each byte.

I²C BUS carries out data transmission with plural devices connected by 2 communication lines of serial data (SDA) and serial clock (SCL).

Among devices, there are “master” that generates clock and control communication start and end, and “slave” that is controlled by addresses peculiar to devices.

EEPROM becomes “slave”. And the device that outputs data to bus during data communication is called “transmitter”, and the device that receives data is called “receiver”.

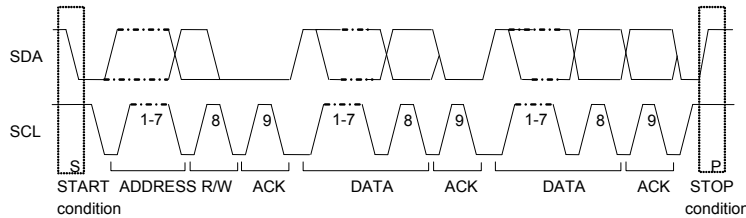

Fig.33 Data transfer timing

○ Start condition (start bit recognition)

- Before executing each command, start condition (start bit) where SDA goes from “HIGH” down to “LOW” when SCL is “HIGH” is necessary.
- This IC always detects whether SDA and SCL are in start condition (start bit) or not, therefore, unless this condition is satisfied, any command is executed.

○ Stop condition (stop bit recognition)

- Each command can be ended by SDA rising from “LOW” to “HIGH” when stop condition (stop bit), namely, SCL is “HIGH”.

○ Acknowledge (ACK) signal

- This acknowledge (ACK) signal is a software rule to show whether data transfer has been made normally or not. In master and slave, the device (μ-COM at slave address input of write command, read command, and this IC at data output of read command) at the transmitter (sending) side releases the bus after output of 8bit data.
- This device (this IC at slave address input of write command, read command, and μ-COM at data output of read command) at the receiver (receiving) side sets SDA “LOW” during 9 clock cycles, and outputs acknowledge signal (ACK signal) showing that it has received the 8bit data.
- This IC, after recognizing start condition and slave address (8bit), outputs acknowledge signal (ACK signal) “LOW”.
- Each write action outputs acknowledge signal (ACK signal) “LOW”, at receiving 8bit data (word address and write data).
- Each read action outputs 8bit data (read data), and detects acknowledge signal (ACK signal) “LOW”.
- When acknowledge signal (ACK signal) is detected, and stop condition is not sent from the master (μ-COM) side, this IC continues data output. When acknowledge signal (ACK signal) is not detected, this IC stops data transfer, and recognizes stop condition (stop bit), and ends read action. And this IC gets in standby status.

○ Device addressing

- Output slave address after start condition from master.
- The significant 4 bits of slave address are used for recognizing a device type. The device code of this IC is fixed to “1010”.
- Next slave addressed (A2 --- device address) are for selecting devices, and plural ones can be used on a same bus according to the number of device addresses.
- The most insignificant bit (R / \bar{W} --- READ / WRITE) of slave address is used for designating write or read action, and is as shown below.

Setting R / \bar{W} to 0 --- write (setting 0 to word address setting of random read)

Setting R / \bar{W} to 1 --- read

Type	Slave address	Maximum number of connected buses
BU9833GUL-W	1 0 1 0 A2 0 0 R / \bar{W}	2

PS is page select bits.

●Command

○Write cycle

- Arbitrary data is written to EEPROM. When to write only 1 byte, byte write is normally used, and when to write continuous data of 2 bytes or more, simultaneous write is possible by page write cycle.

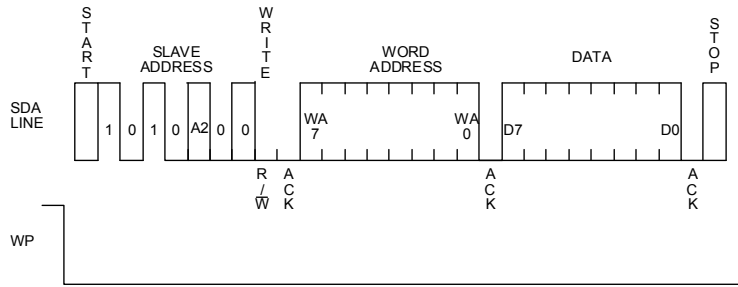

Fig.34 Byte write cycle

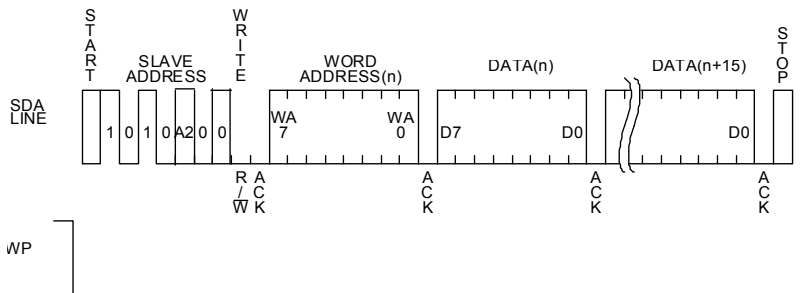

Fig.35 Page write cycle

- Data is written to the address designated by word address (n-th address).
- By issuing stop bit after 8bit data input, write to memory cell inside starts.
- When internal write is started, command is not accepted for tWR (5ms at maximum).
- By page write cycle, the following can be written in bulk. Up to 16 bytes
And when data of the maximum bytes or higher is sent, data from the first byte is overwritten.
(Refer to "Internal address increment" of "Notes on page write cycle" in P8/16.)
- As for page write cycle of BU9833GUL-W, after page select bit (PS) of slave address is designated arbitrarily, by continuing data input of 2 bytes or more, the address of insignificant 4 bits is incremented internally, and data up to 16 bytes can be written.

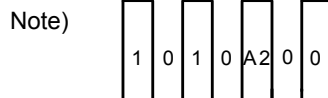

Fig.36 Difference of slave address of each type

Notes on write cycle continuous input

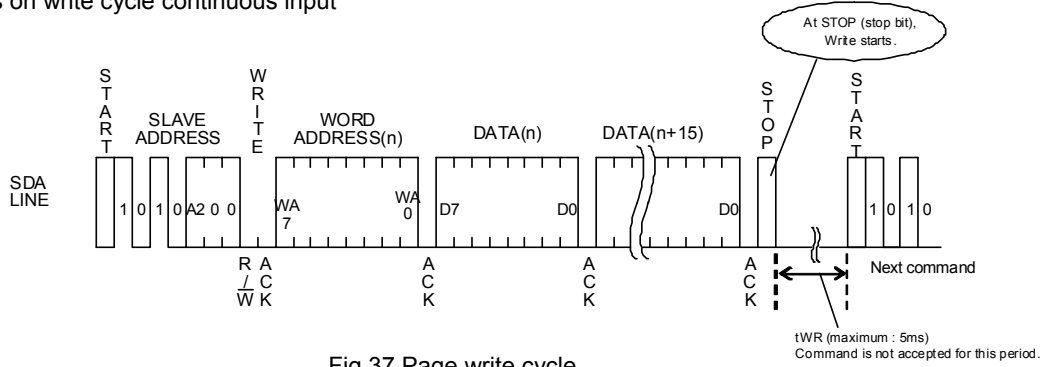

Fig.37 Page write cycle

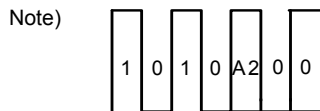

Fig.38 Difference of each type of slave address

Notes on page write cycle

List of numbers of page write

Number of Pages	16Byte
Product number	BU9833GUL-W

The above numbers are maximum bytes for respective types.

Any types below these can be written.

1page = 16 bytes, but the page write cycle write time is 5ms at maximum for 16byte bulk write.

It does not stand 5ms at maximum x 16 bytes = 80ms (Max.).

Internal address increment

Page write mode

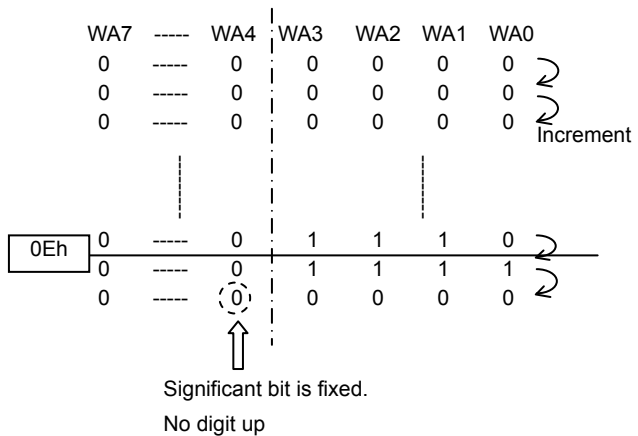

For example, when it is started from address 0Eh, therefore, increment is made as below,
 0Eh→0Fh→00h→01h ---, which please note.
 *0Eh --- 0E in hexadecimal, therefore, 00001110 becomes a binary number.

Write protect terminal (WP)

- Write protect function

When WP terminal is set Vcc (H level), data rewrite of all addresses is prohibited. When it is set GND (L level), data rewrite of all addresses is enabled. Be sure to connect this terminal to Vcc or GND, or control it to H level or L level. Do not use it open.

At extremely low voltage at power ON/OFF, by setting the WP terminal "H", mistake write can be prevented.

During tWR, set the WP terminal always to "L". If it is set "H", write is forcibly terminated.

●Command

○Read cycle

Data of EEPROM is read. In read cycle, there are random read cycle and current read cycle.

Random read cycle is a command to read data by designating address, and is used generally.

Current read cycle is a command to read data of internal address register without designating address, and is used when to verify just after write cycle. In both the read cycles, sequential read cycle is available, and the next address data next address data can be read in succession.

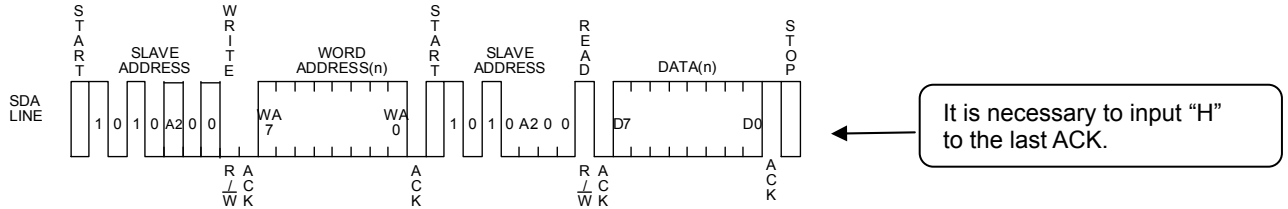

Fig.39 Random Read cycle

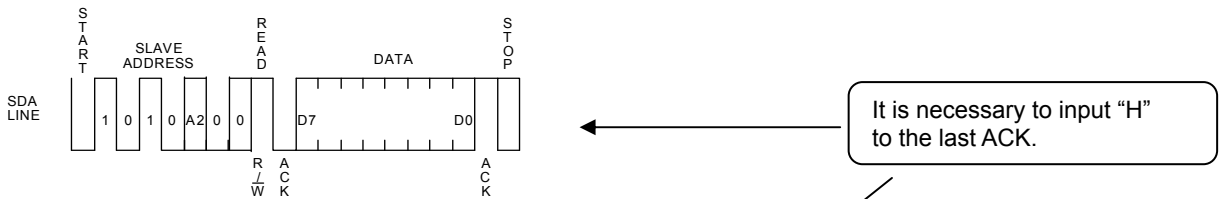

Fig.40 Current read cycle

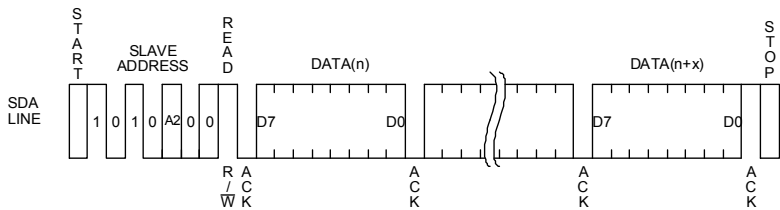

Fig.41 Sequential read cycle

- In random read cycle, data of designated word address can be read.
- When the command just before current read cycle is random read cycle, current read cycle (each including sequential read cycle), data of incremented last read address (n-th) address, i.e., data of the (n+1)-th address is output.
- When ACK signal "LOW" after D0 is detected, and stop condition is not sent from the master (μ -COM) side, the next address data can be read in succession.
- Read cycle is ended by stop condition where "H" is input to ACK signal after D0 and SDA signal is started at SCL signal "H".
- When "H" is not input to ACK signal after D0, sequential read gets in, and the next data is output. Therefore, read command cycle cannot be ended. When to end read command cycle, be sure input stop condition to input "H" to ACK signal after D0, and to start SDA at SCL signal "H".
- Sequential read is ended by stop condition where "H" is input to ACK signal after arbitrary D0 and SDA is started at SCL signal "H".

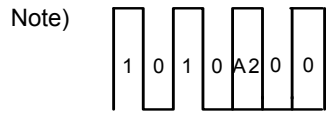

Fig.42 Difference of slave address of each type

●Software reset

Software reset is executed when to avoid malfunction after power on, and to reset during command input. Software reset has several kinds, and 3 kinds of them are shown in the figure below. (Refer to Fig.43(a), Fig.43(b) and Fig.43(c).) In dummy clock input area, release the SDA bus ("H" by pull up). In dummy clock area, ACK output and read data "0" (both "L" level) may be output from EEPROM, therefore, if "H" is input forcibly, output may conflict and over current may flow, leading to instantaneous power failure of system power source or influence upon devices.

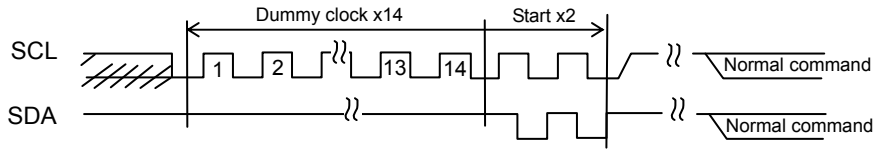

Fig.43-(a) The case of dummy clock + START + START + command input

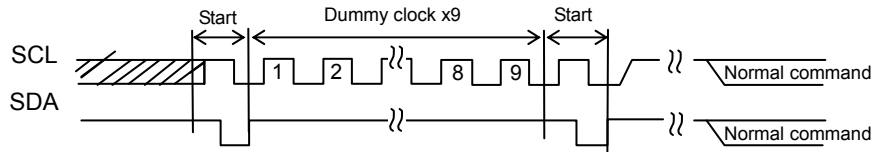

Fig.43-(b) The case of START + 9 dummy clocks + START + command input

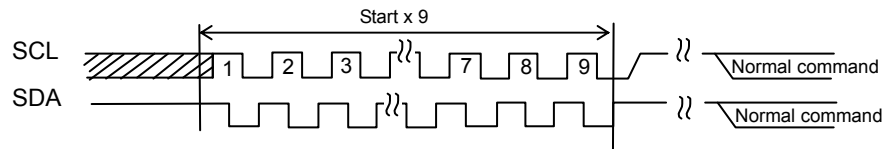

Fig.43-(c) START x 9 + command input

* Start normal command from START input.

●Acknowledge polling

During internal write execution, all input commands are ignored, therefore ACK is not sent back. During internal automatic write execution after write cycle input, next command (slave address) is sent, and if the first ACK signal sends back "L", then it means end of write action, while if it sends back "H", it means now in writing. By use of acknowledge polling, next command can be executed without waiting for $t_{WR}=5ms$.

When to write continuously, $R/\bar{W} = 0$, when to carry out current read cycle after write, slave address $R/\bar{W} = 1$ is sent, and if ACK signal sends back "L", then execute word address input and data output and so forth.

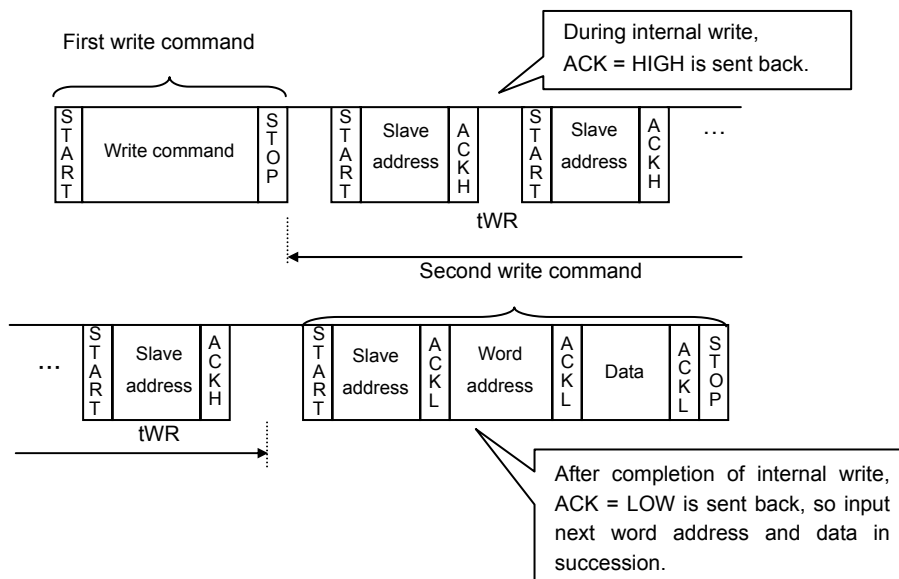

Fig.44 Case to continuously write by acknowledge polling

●WP valid timing (write cancel)

WP is usually to “H” or “L”, but when WP is used to cancel write cycle and so forth, pay attention to the following WP valid timing. During write cycle execution, in cancel valid area, by setting WP = “H”, write cycle can be cancelled. In both byte write cycle and page write cycle, the area from the first start condition of command to the rise of clock to taken in D0 of data (in page write cycle, the first byte data) is cancel invalid area.

WP input in this area becomes Don't care. Set the setup time to rise of D0 taken SCL 100ns or more. The area from the rise of SCL to take in D0 to the end of internal automatic write (tWR) is cancel valid area. And, when it is set WP = “H” during tWR, write is ended forcibly, data of address under access is not guaranteed, therefore, write it once again. (Refer to Fig.45.) After execution of forced end by WP, standby status gets in, so there is no need to wait for tWR (5ms at maximum).

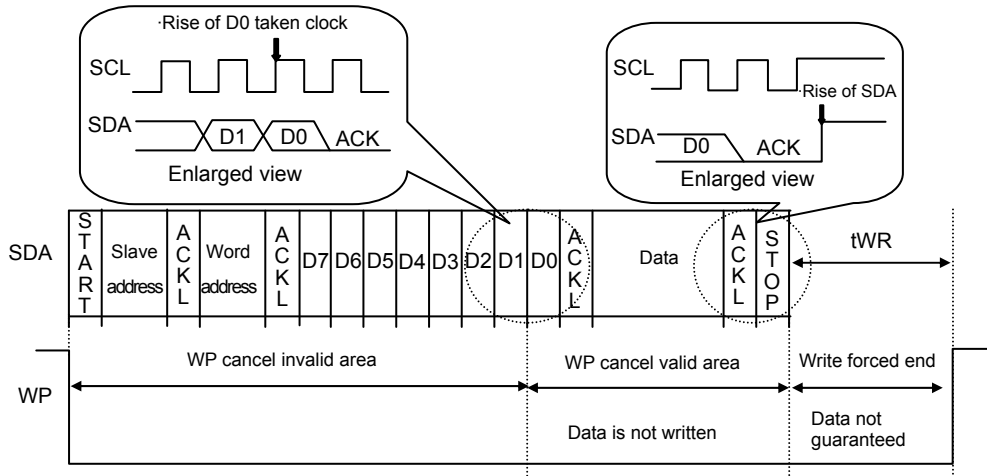

Fig. 45 WP valid timing

●Command cancel by start condition and stop condition

During command input, by continuously inputting start condition and stop condition, command can be cancelled. (Refer to fig.46) However, in ACK output area and during data read, SDA bus may output “L”, and in this case, start condition and stop condition cannot be input, so reset is not available. Therefore, execute software reset. and when command is cancelled by start, stop condition, during random read cycle, sequential read cycle, or current read cycle, internal setting address is not determined, therefore, it is not possible to carry out current read cycle in succession. When to carry out read cycle in succession, carry out random read cycle.

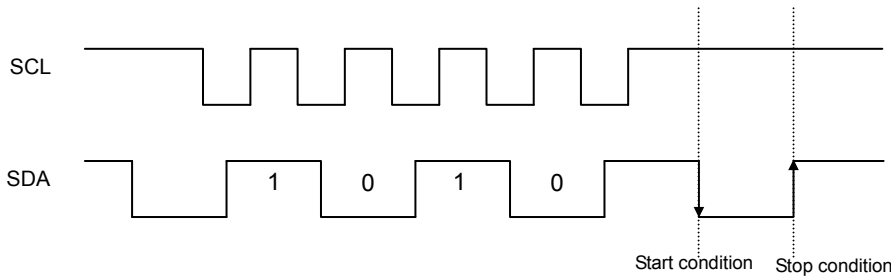

Fig. 46 Case of cancel by start, stop condition during slave address input

● I/O peripheral circuit

○ Pull up resistance of SDA terminal

SDA is NMOS open drain, so requires pull up resistance. As for this resistance value (R_{PU}), select an appropriate value to this resistance value from microcontroller V_{IL} , I_L , and $V_{OL}-I_{OL}$ characteristics of this IC. If R_{PU} is large, action frequency is limited. The smaller the R_{PU} , the larger the consumption current at action.

○ Maximum value of R_{PU}

The maximum value of R_{PU} is determined by the following factors.

- (1) SDA rise time to be determined by the capacity (CBUS) of bus line of R_{PU} and SDA should be tR or below. And AC timing should be satisfied even when SDA rise time is late.
- (2) The bus electric potential Ⓢ to be determined by input leak total (I_L) of device connected to bus at output of "H" to SDA bus and R_{PU} should sufficiently secure the input "H" level (V_{IH}) of microcontroller and EEPROM including recommended noise margin $0.2V_{CC}$.

$$V_{CC} - I_L R_{PU} - 0.2 V_{CC} \geq V_{IH}$$

$$\therefore R_{PU} \leq \frac{0.8V_{CC} - V_{IH}}{I_L}$$

Ex.) When $V_{CC} = 3V$, $I_L = 10\mu A$, $V_{IH} = 0.7 V_{CC}$ from (2)

$$R_{PU} \leq \frac{0.8 \times 3 - 0.7 \times 3}{10 \times 10^{-6}}$$

$$\leq 300 \quad [k\Omega]$$

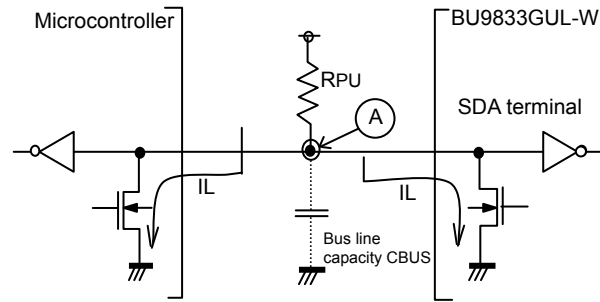

Fig.47 I/O circuit diagram

○ Minimum value of R_{PU}

The minimum value of R_{PU} is determined by the following factors.

- (1) When IC outputs LOW, it should be satisfied that $V_{OLMAX} = 0.4V$ and $I_{OLMAX} = 3mA$.

$$\frac{V_{CC} - V_{OL}}{R_{PU}} \leq I_{OL} \quad \therefore R_{PU} \geq \frac{V_{CC} - V_{OL}}{I_{OL}}$$

- (2) $V_{OLMAX} = 0.4V$ should secure the input "L" level (V_{IL}) of microcontroller and EEPROM including recommended noise margin $0.1V_{CC}$.

$$V_{OLMAX} \leq V_{IL} - 0.1V_{CC}$$

Ex.) When $V_{CC} = 3V$, $V_{OL} = 0.4V$, $I_{OL} = 3mA$, microcontroller, EEPROM $V_{IL} = 0.3V_{CC}$

From (1), $\therefore R_{PU} \geq \frac{3 - 0.4}{3 \times 10^{-3}}$

$$\geq 867 [\Omega]$$

And $V_{OL} = 0.4 [V]$
 $V_{IL} = 0.3 \times 3 = 0.9 [V]$

Therefore, the condition (2) is satisfied.

○ Pull up resistance of SCL terminal

When SCL control is made at CMOS output port, there is no need, but in the case there is timing where SCL becomes "Hi-Z", add a pull up resistance. As for the pull up resistance, one of several $k\Omega \sim$ several ten $k\Omega$ is recommended in consideration of drive performance of output port of microcontroller.

● A2, WP process

○ Process of device address terminals (A2)

Check whether the set device address coincides with device address input sent from the master side or not, and select one among plural devices connected to a same bus. Connect this terminal to pull up of pull down, or V_{CC} or GND.

○ Process of WP terminal

WP terminal is the terminal that prohibits and permits write in hardware manner. In "H" status, only READ is available and WRITE of all addresses is prohibited. In the case of "L", both are available. In the case to use it as an ROM, it is recommended to connect it to pull up or V_{CC} . In the case to use both READ and WRITE, control WP terminal or connect it to pull down or GND.

●Cautions on microcontroller connection

○Rs

In I²C BUS, it is recommended that SDA port is of open drain input / output. However, when to use COMS input / output of tri state to SDA port, insert a series resistance Rs between the pull up resistance R_{PU} and the SDA terminal of EEPROM. This controls over protection of SDA terminal against surge. Therefore, even when SDA port is open drain input / output, Rs can be used.

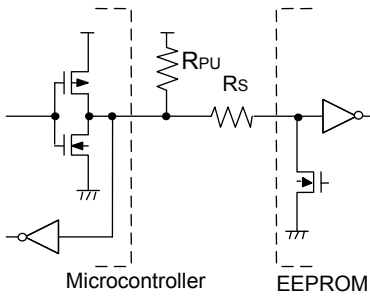

Fig.48 I/O circuit diagram

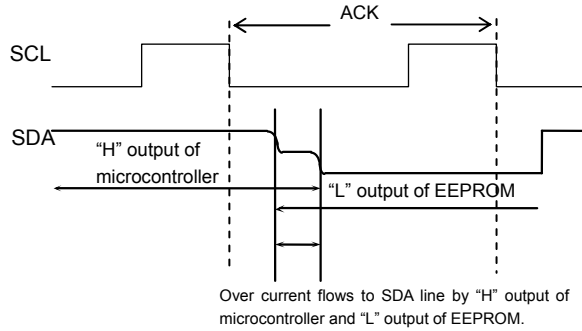

Fig.49 Input / output collision timing

○Maximum value of Rs

The maximum value of Rs is determined by the following relations.

- (1) SDA rise time to be determined by the capacity (CBUS) of bus line of R_{PU} and SDA should be t_R or below. And AC timing should be satisfied even when SDA rise time is late.
- (2) The bus electric potential A to be determined by R_{PU} and Rs at the moment when EEPROM outputs "L" to SDA bus should sufficiently secure the input "L" level (V_{IL}) of microcontroller including recommended noise margin 0.1V_{CC}.

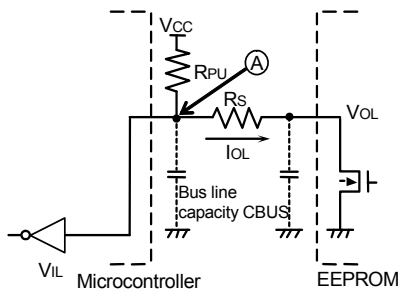

Fig.50 I/O circuit diagram

$$\frac{(V_{CC}-V_{OL}) \times R_s}{R_{PU}+R_s} + V_{OL} + 0.1V_{CC} \leq V_{IL}$$

$$\therefore R_s \leq \frac{V_{IL}-V_{OL}-0.1V_{CC}}{1.1V_{CC}-V_{IL}} \times R_{PU}$$

Example) When V_{CC}=3V, V_{IL}=0.3V_{CC}, V_{OL}=0.4V, R_{PU}=20kΩ,

$$\text{From (2)} \quad R_s \leq \frac{0.3 \times 3 - 0.4 - 0.1 \times 3}{1.1 \times 3 - 0.3 \times 3} \times 20 \times 10^3$$

$$\leq 1.67 \text{ [k}\Omega\text{]}$$

○Minimum value of Rs

The minimum value of Rs is determined by over current at bus collision. When over current flows, noises in power source line, and instantaneous power failure of power source may occur. When allowable over current is defined as I, the following relation must be satisfied. Determine the allowable current in consideration of impedance of power source line in set and so forth. Set the over current to EEPROM 10mA or below.

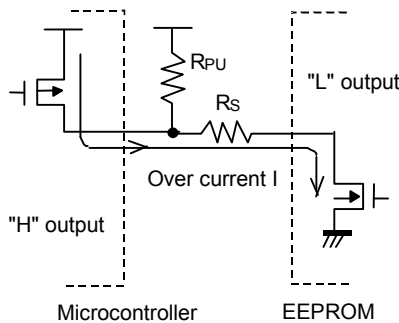

Fig.51 I/O Circuit diagram

$$\frac{V_{CC}}{R_s} \leq I$$

$$R_s \geq \frac{V_{CC}}{I}$$

Example) When V_{CC} = 3V, I = 10mA,

$$R_s \geq \frac{3}{10 \times 10^{-3}}$$

$$\geq 300 \text{ [}\Omega\text{]}$$

●I²C BUS input / output circuit

○Input (A2,SCL)

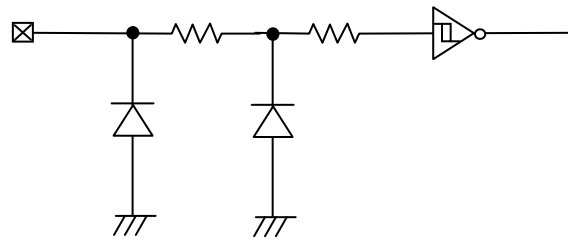

Fig.52 Input pin circuit diagram

○Input / output (SDA)

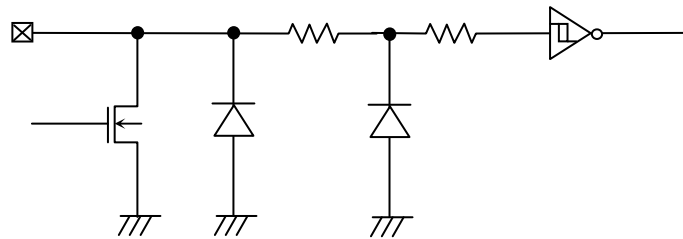

Fig.53 Input / output pin circuit diagram

○Input (WP)

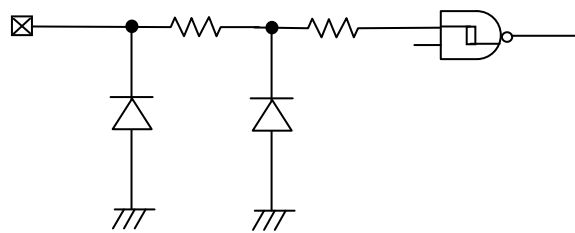

Fig.54 Input pin circuit diagram

●Notes on power ON

At power on, in IC internal circuit and set, Vcc rises through unstable low voltage area, and IC inside is not completely reset, and malfunction may occur. To prevent this, function of POR circuit and LVCC circuit are equipped. To assure the action, observe the following conditions at power on.

1. Set SDA= "H" and SCL = "L" or "H".
2. Start power source so as to satisfy the recommended conditions of tR, tOFF, and Vbot for operating POR circuit.

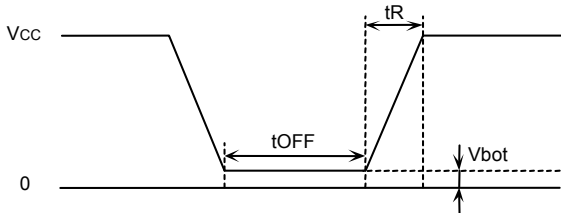

Fig. 55 Rise waveform diagram

Recommended conditions of tR, tOFF, Vbot

tR	tOFF	Vbot
10ms or below	10ms or higher	0.3V or below
100ms or below	10ms or higher	0.2V or below

3. Set SDA and SCL so as not to become "Hi-Z".

When the above conditions 1 and 2 cannot be observed, take the following countermeasures.

- a) In the case when the above condition 1 cannot be observed. When SDA becomes "L" at power on.

→ Control SCL and SDA as shown below, to make SCL and, "H" and "H".

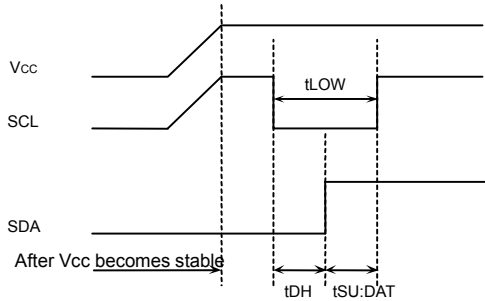

Fig.56 When SCL ="H" and SDA = "L"

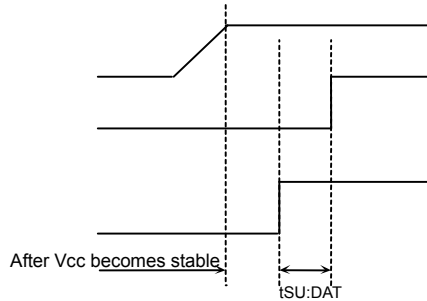

Fig.57 When SCL = "H" and SDA = "L"

- b) In the case when the above condition 2 cannot be observed.

→ After power source becomes stable, execute software reset (P10).

- c) In the case when the above conditions 1 and 2 cannot be observed.

→ Carry out a), and then carry out b).

●Low voltage malfunction prevention function

LVCC circuit prevents data rewrite action at low power, and prevents wrong write. At LVCC voltage (Typ. = 1.2V) or below, it prevent data rewrite.

●Vcc noise countermeasures

○Bypass capacitor

When noise or surge gets in the power source line, malfunction may occur, therefore, for removing these, it is recommended to attach a bypass capacitor (0.1μF) between IC Vcc and GND. At that moment, attach it as close to IC as possible.

And, it is also recommended to attach a bypass capacitor between board Vcc and GND.

●Notes for use

- (1) Described numeric values and data are design representative values, and the values are not guaranteed.
- (2) We believe that application circuit examples are recommendable, however, in actual use, confirm characteristics further sufficiently. In the case of use by changing the fixed number of external parts, make your decision with sufficient margin in consideration of static characteristics and transition characteristics and fluctuations of external parts and our LSI.
- (3) Absolute maximum ratings
If the absolute maximum ratings such as impressed voltage and action temperature range and so forth are exceeded, LSI may be destructed. Do not impress voltage and temperature exceeding the absolute maximum ratings. In the case of fear exceeding the absolute maximum ratings, take physical safety countermeasures such as fuses, and see to it that conditions exceeding the absolute maximum ratings should not be impressed to LSI.
- (4) GND electric potential
Set the voltage of GND terminal lowest at any action condition. Make sure that each terminal voltage is lower than that of GND terminal.
- (5) Thermal design
In consideration of permissible loss in actual use condition, carry out heat design with sufficient margin.
- (6) Terminal to terminal shortcircuit and wrong packaging
When to package LSI onto a board, pay sufficient attention to LSI direction and displacement. Wrong packaging may destruct LSI. And in the case of shortcircuit between LSI terminals and terminals and power source, terminal and GND owing to foreign matter, LSI may be destructed.
- (7) Use in a strong electromagnetic field may cause malfunction, therefore, evaluate design sufficiently.

●Ordering part number

B	U	9	8	3	3	G	U	L	-	W	E	2
Part No.		Part No.				Package GUL : VCSP50L1		W-CELL		Packaging and forming specification E2: Embossed tape and reel		

VCSP50L1(BU9833GUL-W)

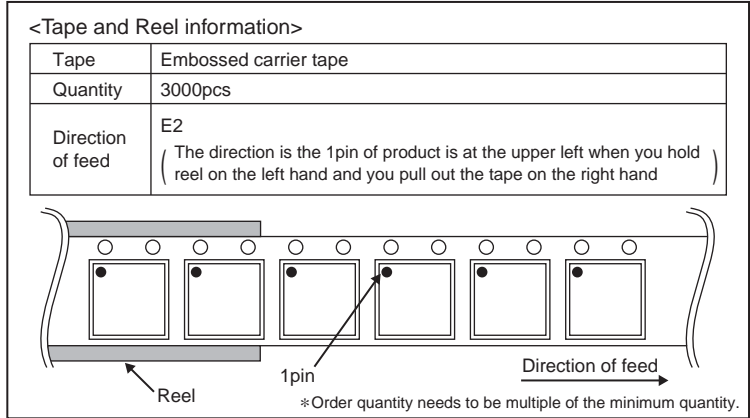
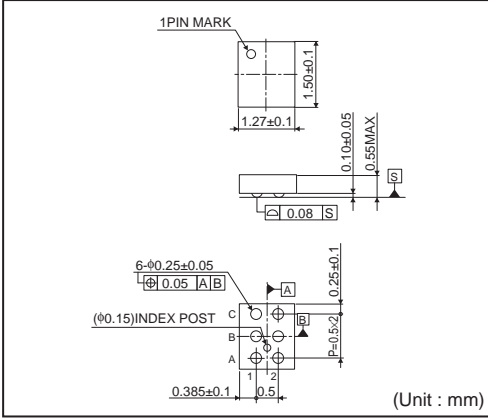

Notes

No copying or reproduction of this document, in part or in whole, is permitted without the consent of ROHM Co.,Ltd.

The content specified herein is subject to change for improvement without notice.

The content specified herein is for the purpose of introducing ROHM's products (hereinafter "Products"). If you wish to use any such Product, please be sure to refer to the specifications, which can be obtained from ROHM upon request.

Examples of application circuits, circuit constants and any other information contained herein illustrate the standard usage and operations of the Products. The peripheral conditions must be taken into account when designing circuits for mass production.

Great care was taken in ensuring the accuracy of the information specified in this document. However, should you incur any damage arising from any inaccuracy or misprint of such information, ROHM shall bear no responsibility for such damage.

The technical information specified herein is intended only to show the typical functions of and examples of application circuits for the Products. ROHM does not grant you, explicitly or implicitly, any license to use or exercise intellectual property or other rights held by ROHM and other parties. ROHM shall bear no responsibility whatsoever for any dispute arising from the use of such technical information.

The Products specified in this document are intended to be used with general-use electronic equipment or devices (such as audio visual equipment, office-automation equipment, communication devices, electronic appliances and amusement devices).

The Products specified in this document are not designed to be radiation tolerant.

While ROHM always makes efforts to enhance the quality and reliability of its Products, a Product may fail or malfunction for a variety of reasons.

Please be sure to implement in your equipment using the Products safety measures to guard against the possibility of physical injury, fire or any other damage caused in the event of the failure of any Product, such as derating, redundancy, fire control and fail-safe designs. ROHM shall bear no responsibility whatsoever for your use of any Product outside of the prescribed scope or not in accordance with the instruction manual.

The Products are not designed or manufactured to be used with any equipment, device or system which requires an extremely high level of reliability the failure or malfunction of which may result in a direct threat to human life or create a risk of human injury (such as a medical instrument, transportation equipment, aerospace machinery, nuclear-reactor controller, fuel-controller or other safety device). ROHM shall bear no responsibility in any way for use of any of the Products for the above special purposes. If a Product is intended to be used for any such special purpose, please contact a ROHM sales representative before purchasing.

If you intend to export or ship overseas any Product or technology specified herein that may be controlled under the Foreign Exchange and the Foreign Trade Law, you will be required to obtain a license or permit under the Law.



Thank you for your accessing to ROHM product informations.
More detail product informations and catalogs are available, please contact us.

ROHM Customer Support System

<http://www.rohm.com/contact/>