

## IGBT MODULE ( N series )

### ■ Features

- Square RBSOA
- Low Saturation Voltage
- Less Total Power Dissipation
- Improved FWD Characteristic
- Minimized Internal Stray Inductance
- Overcurrent Limiting Function (4-5 Times Rated Current)

### ■ Applications

- High Power Switching
- A.C. Motor Controls
- D.C. Motor Controls
- Uninterruptible Power Supply

### ■ Outline Drawing

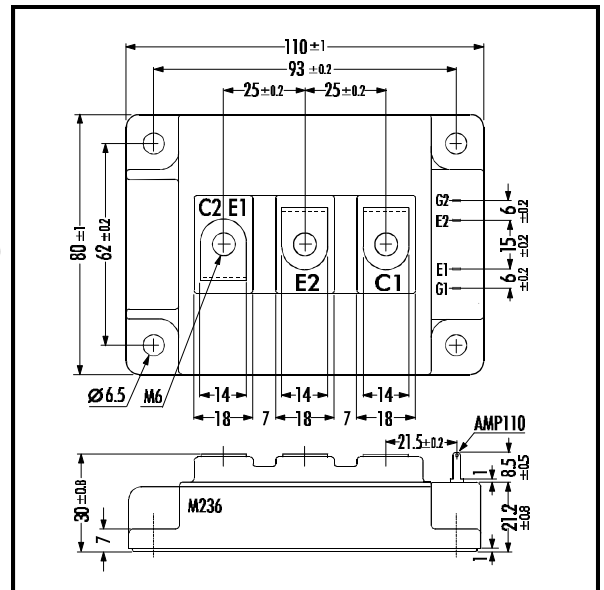

### ■ Maximum Ratings and Characteristics

#### • Absolute Maximum Ratings ( T<sub>c</sub>=25°C )

Items	Symbols	Ratings	Units
Collector-Emitter Voltage	V <sub>CE(S)</sub>	1200	V
Gate -Emitter Voltage	V <sub>GES</sub>	± 20	V
Collector Current	Continuous	I <sub>C</sub>	300
	1ms	I <sub>C PULSE</sub>	600
	Continuous	-I <sub>C</sub>	300
	1ms	-I <sub>C PULSE</sub>	600
Max. Power Dissipation	P <sub>C</sub>	2100	W
Operating Temperature	T <sub>j</sub>	+150	°C
Storage Temperature	T <sub>stg</sub>	-40 ~ +125	°C
Isolation Voltage	V <sub>is</sub>	2500	V
Screw Torque	Mounting *1	3.5	Nm
	Terminals *2	4.5	

Note: \*1:Recommendable Value; 2.5 - 3.5 Nm (M5) or (M6)  
\*2:Recommendable Value; 3.5 - 4.5 Nm (M6)

#### • Electrical Characteristics ( at T<sub>j</sub>=25°C )

Items	Symbols	Test Conditions	Min.	Typ.	Max.	Units
Zero Gate Voltage Collector Current	I <sub>CE(S)</sub>	V <sub>GE</sub> =0V V <sub>CE</sub> =1200V			3.0	mA
Gate-Emitter Leakage Current	I <sub>GES</sub>	V <sub>CE</sub> =0V V <sub>GE</sub> =± 20V			45	μA
Gate-Emitter Threshold Voltage	V <sub>GE(th)</sub>	V <sub>GE</sub> =20V I <sub>C</sub> =300mA	4.5		7.5	V
Collector-Emitter Saturation Voltage	V <sub>CE(sat)</sub>	V <sub>GE</sub> =15V I <sub>C</sub> =300A			3.3	V
Input capacitance	C <sub>ies</sub>	V <sub>GE</sub> =0V		48000		pF
Output capacitance	C <sub>oes</sub>	V <sub>CE</sub> =10V		17400		
Reverse Transfer capacitance	C <sub>res</sub>	f=1MHz		15480		
Turn-on Time	t <sub>ON</sub>	V <sub>CC</sub> =600V			1.2	μs
	t <sub>r</sub>	I <sub>C</sub> =300A		0.25	0.6	
Turn-off Time	t <sub>OFF</sub>	V <sub>GE</sub> =± 15V			1.5	
	t <sub>f</sub>	R <sub>G</sub> =2.7Ω		0.35	0.5	
Diode Forward On-Voltage	V <sub>F</sub>	I <sub>F</sub> =300A V <sub>GE</sub> =0V			3.0	V
Reverse Recovery Time	t <sub>rr</sub>	I <sub>F</sub> =300A			350	ns

#### • Thermal Characteristics

Items	Symbols	Test Conditions	Min.	Typ.	Max.	Units
Thermal Resistance	R <sub>th(j-c)</sub>	IGBT			0.06	°C/W
	R <sub>th(j-e)</sub>	Diode			0.15	
	R <sub>th(c-f)</sub>	With Thermal Compound		0.0167		

### ■ Equivalent Circuit

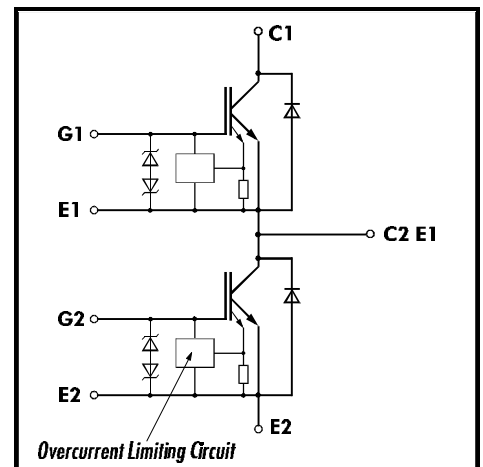

Collector current vs. Collector-Emittter voltage

$T_j=25^\circ\text{C}$

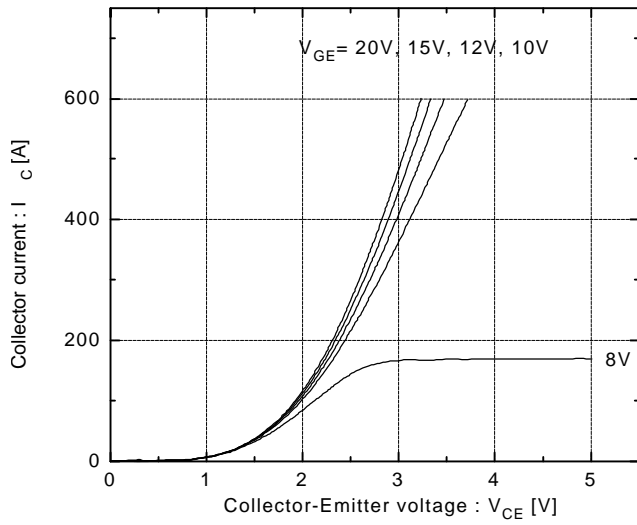

Collector current vs. Collector-Emittter voltage

$T_j=125^\circ\text{C}$

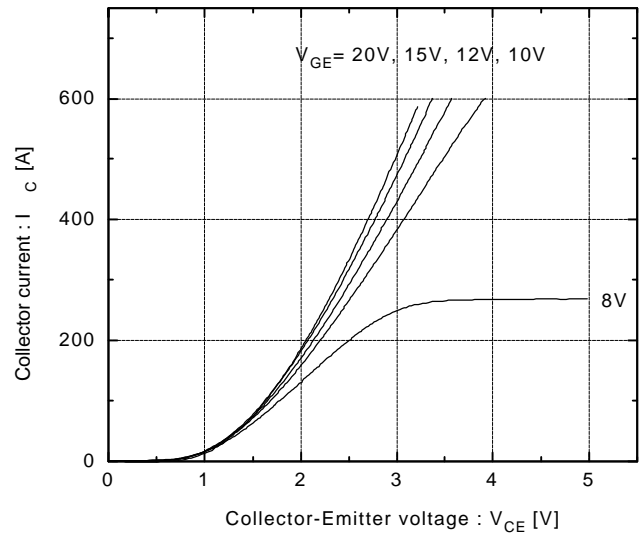

Collector-Emittter vs. Gate-Emittter voltage

$T_j=25^\circ\text{C}$

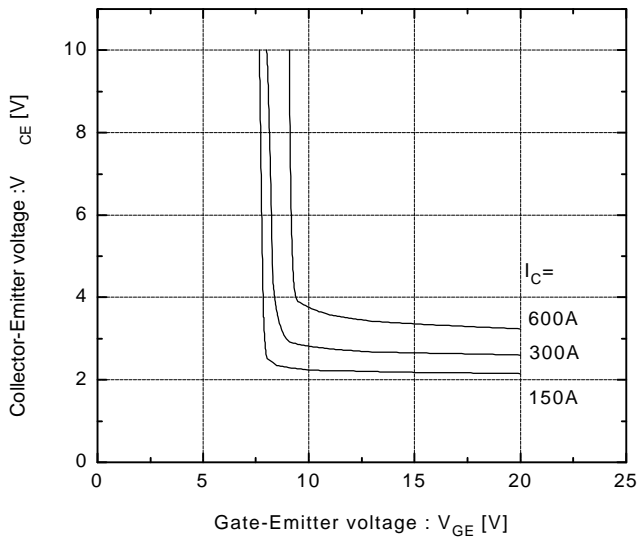

Collector-Emittter vs. Gate-Emittter voltage

$T_j=125^\circ\text{C}$

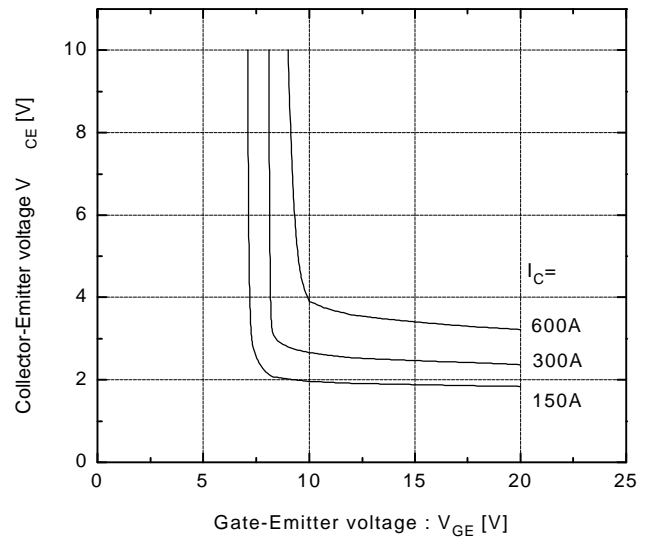

Switching time vs. Collector current

$V_{CC}=600\text{V}, R_G=2.7\Omega, V_{GE}=\pm 15\text{V}, T_j=25^\circ\text{C}$

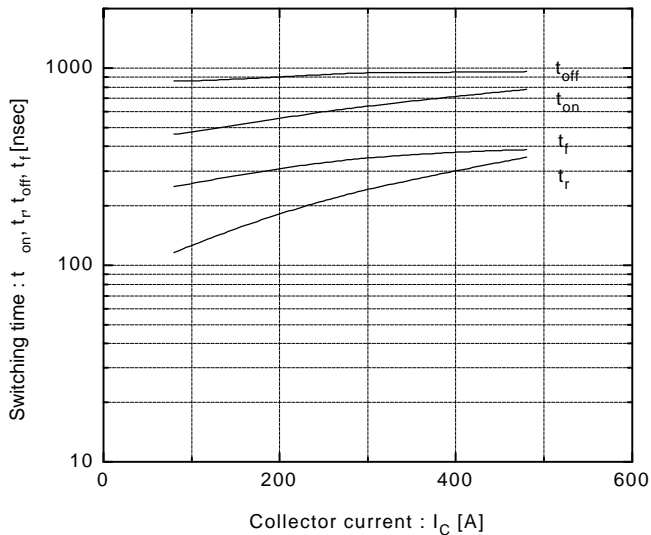

Switching time vs. Collector current

$V_{CC}=600\text{V}, R_G=2.7\Omega, V_{GE}=\pm 15\text{V}, T_j=125^\circ\text{C}$

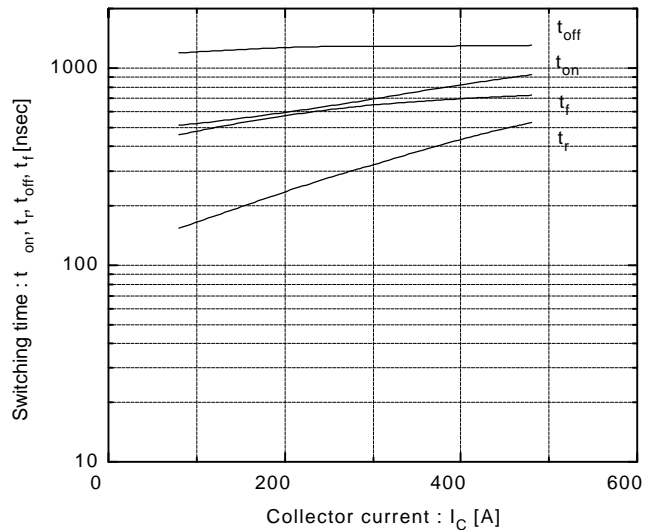

Switching time vs.  $R_G$

$V_{CC}=600V, I_C=300A, V_{GE}=\pm 15V, T_j=25^\circ C$

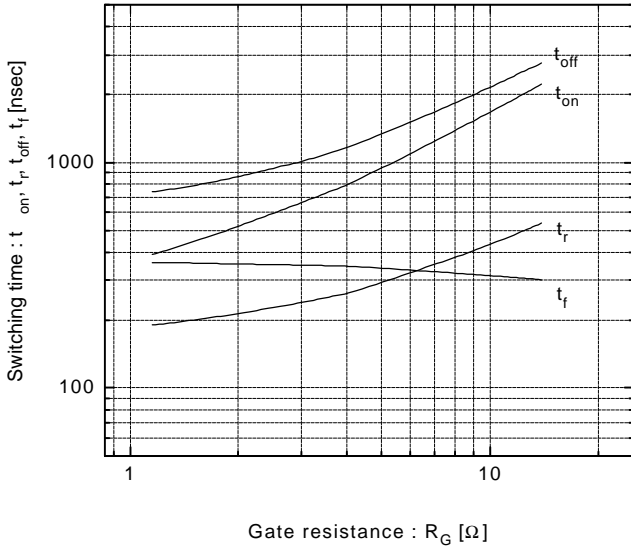

Dynamic input characteristics

$T_j=25^\circ C$

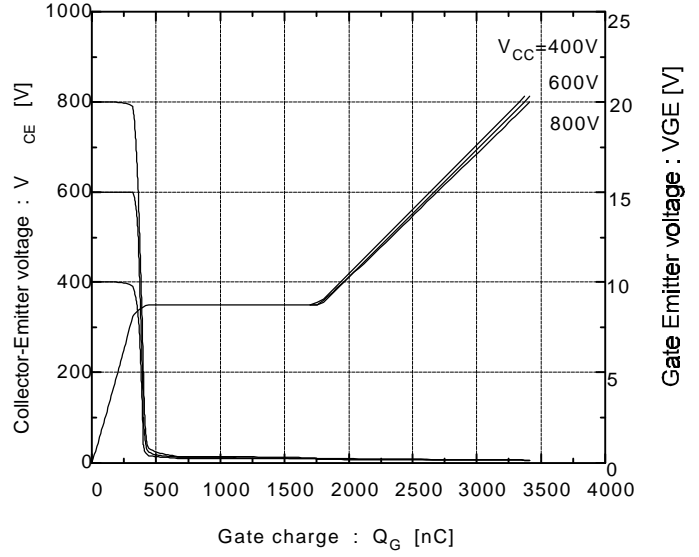

Forward current vs. Forward voltage

$V_{GE}=0V$

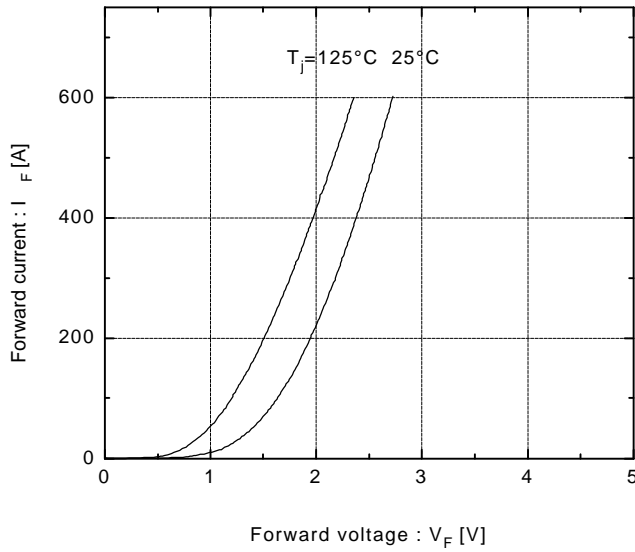

Reverse recovery characteristics

$t_{rr}, I_{rr}$  vs.  $I_F$

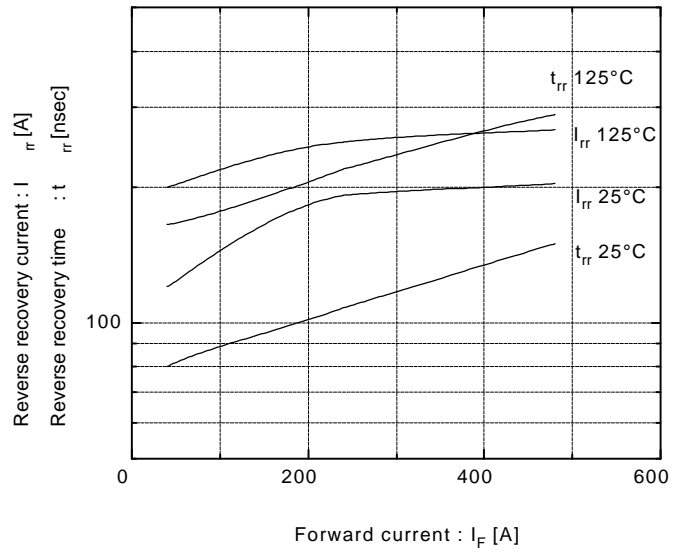

Transient thermal resistance

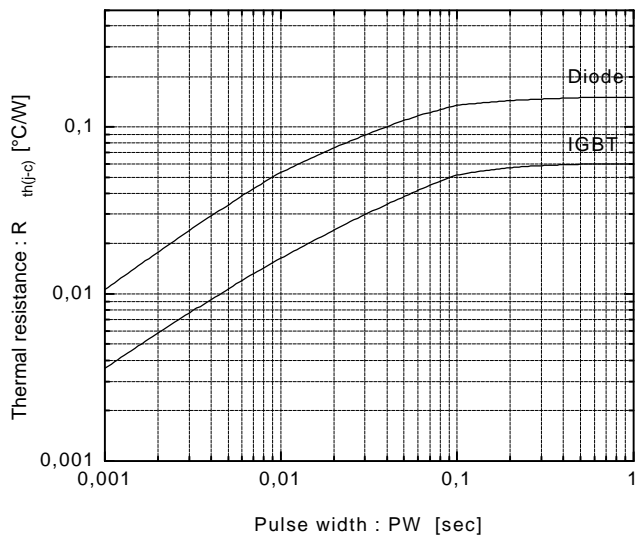

Reversed biased safe operating area

$+V_{GE}=15V, -V_{GE}\leq 15V, T_j\leq 125^\circ C, R_G\geq 2.7\Omega$

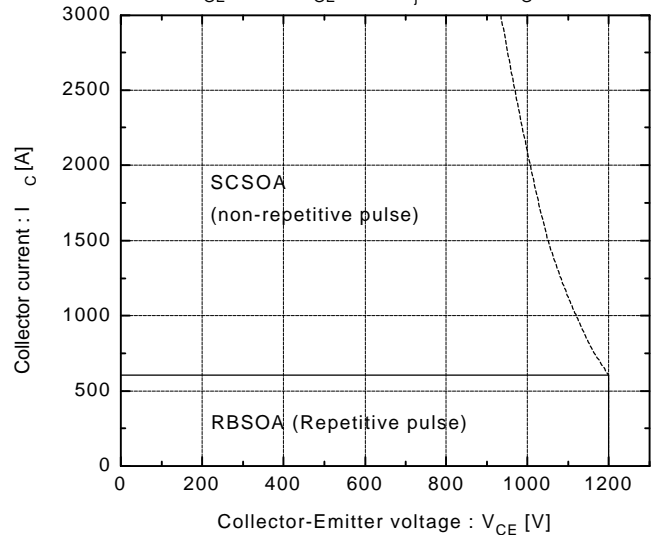

Switching loss vs. Collector current

$V_{CC}=600V, R_{GE}=2.7\Omega, V_{GE}=\pm 15V$

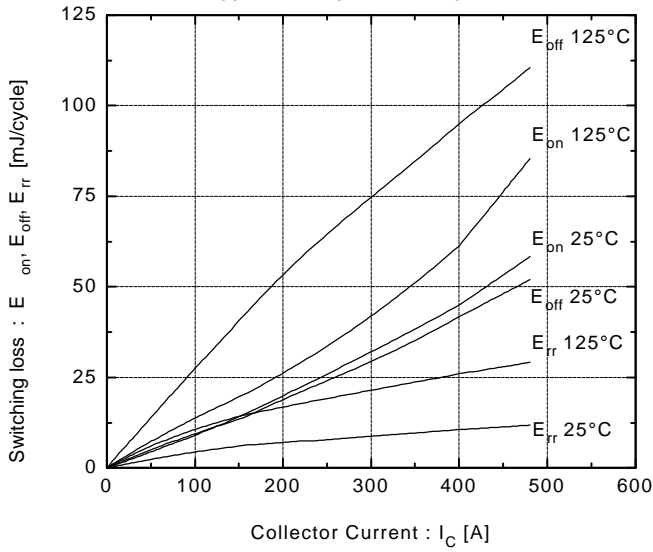

Capacitance vs. Collector-Emitter voltage

$T_j=25^\circ C$

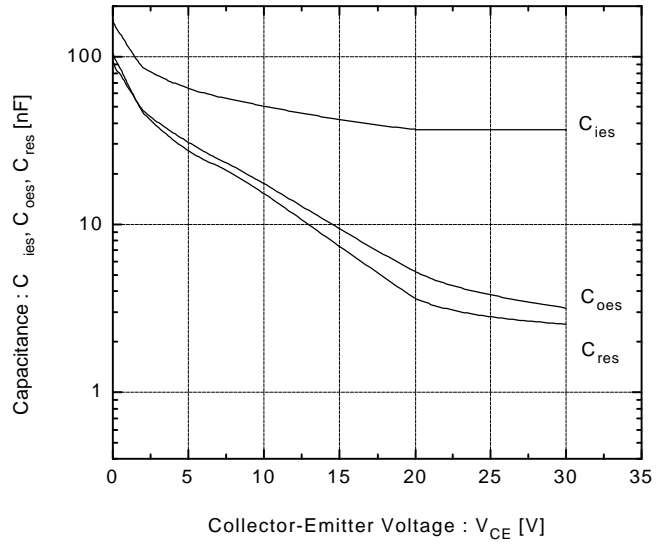

**Fuji Electric GmbH**

Lyoner Straße 26

D-60528 Frankfurt/M

Tel.: 069 - 66 90 29 - 0

Fax.: 069 - 66 90 29 - 56

**Fuji Electric (UK) Ltd.**

Commonwealth House  
2 Chalkhill Road Hammersmith

London W6 8DW, UK

Tel.: 0181 - 233 11 30

Fax.: 0181 - 233 11 60