

TFT COLOR LCD MODULE

NL10276AC30-01A

**38 cm (15 inches), 1024 × 768 pixels, Full-color,
Multi-scan Function, Built-in backlight with inverter
Ultra wide viewing angle**

DESCRIPTION

NL10276AC30-01A is a TFT (thin film transistor) active matrix color liquid crystal display (LCD) comprising amorphous silicon TFT attached to each signal electrode, a driving circuit, a CRT interface board and a backlight. NL10276AC30-01A has a built-in backlight with an inverter.

The 38cm (15" inches) diagonal display area contains 1024 × 768 pixels and can display full-color (more than 16 million colors simultaneously). Also, it has ultra-wide viewing angle and multi-scan function. Therefore, this module calls Super Fine TFT.

CRT interface board installed in this module allows you to achieve the LCD monitor with an analog RGB interface.

FEATURES

- Ultra wide viewing angle
- Multi-scan function
 - e.g. XGA, SVGA, VGA, VGA-TEXT, PC-9801, MAC
- High luminance
- Incorporated edge type backlight (Four lamps into two lamp holders, Inverter)
- Lamp holder replaceable (Part No. 150LHS01)
- On Screen Display
- CRT interface board
 - Auto recognition of input signal
 - Analog RGB signals, Sync on green, Synchronous signals (HS, Vsync, Composite)
 - Digital control: e.g. Brightness, Display position, Contrast, CLK delay
 - Free supply voltage sequence
 - Corresponding to DDC1 and DDC2B
 - Corresponding to VESA DPMS

Regarding the use of OSD, please note that there is possibility of conflicts with a patent in Europe and the U.S. Thus, if such conflict might happen when you use OSD, we shall not be responsible for any trouble.

VESA : Video Electronics Standards Association

DPMS : Display Power Management Signaling

DDC1 : Display Data Channel 1

DDC2B : Display Data Channel 2B

APPLICATIONS

- Engineering workstation (EWS), Desk-top type of PC

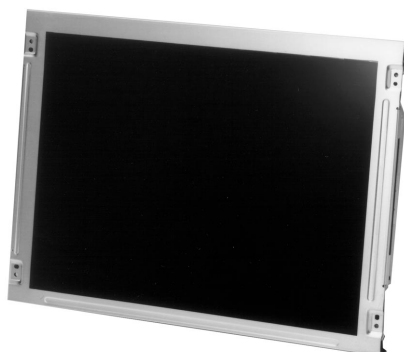

The information in this document is subject to change without notice.

STRUCTURE AND FUNCTIONS

A color TFT (thin film transistor) LCD module is comprised of a TFT liquid crystal panel structure, LSIs for driving the TFT array, and a backlight assembly. The TFT panel structure is created by sandwiching liquid crystal material in the narrow gap between a TFT array glass substrate and a color filter glass substrate. After the driver LSIs are connected to the panel, the backlight assembly is attached to the backside of the panel.

RGB (red, green, blue) data signals from a source system is modulated into a form suitable for active matrix addressing by the onboard signal processor and sent to the driver LSIs which in turn addresses the individual TFT cells.

Acting as an electro-optical switch, each TFT cell regulates light transmission from the backlight assembly when activated by the data source. By regulating the amount of light passing through the array of red, green, and blue dots, color images are created with clarity.

BLOCK DIAGRAM

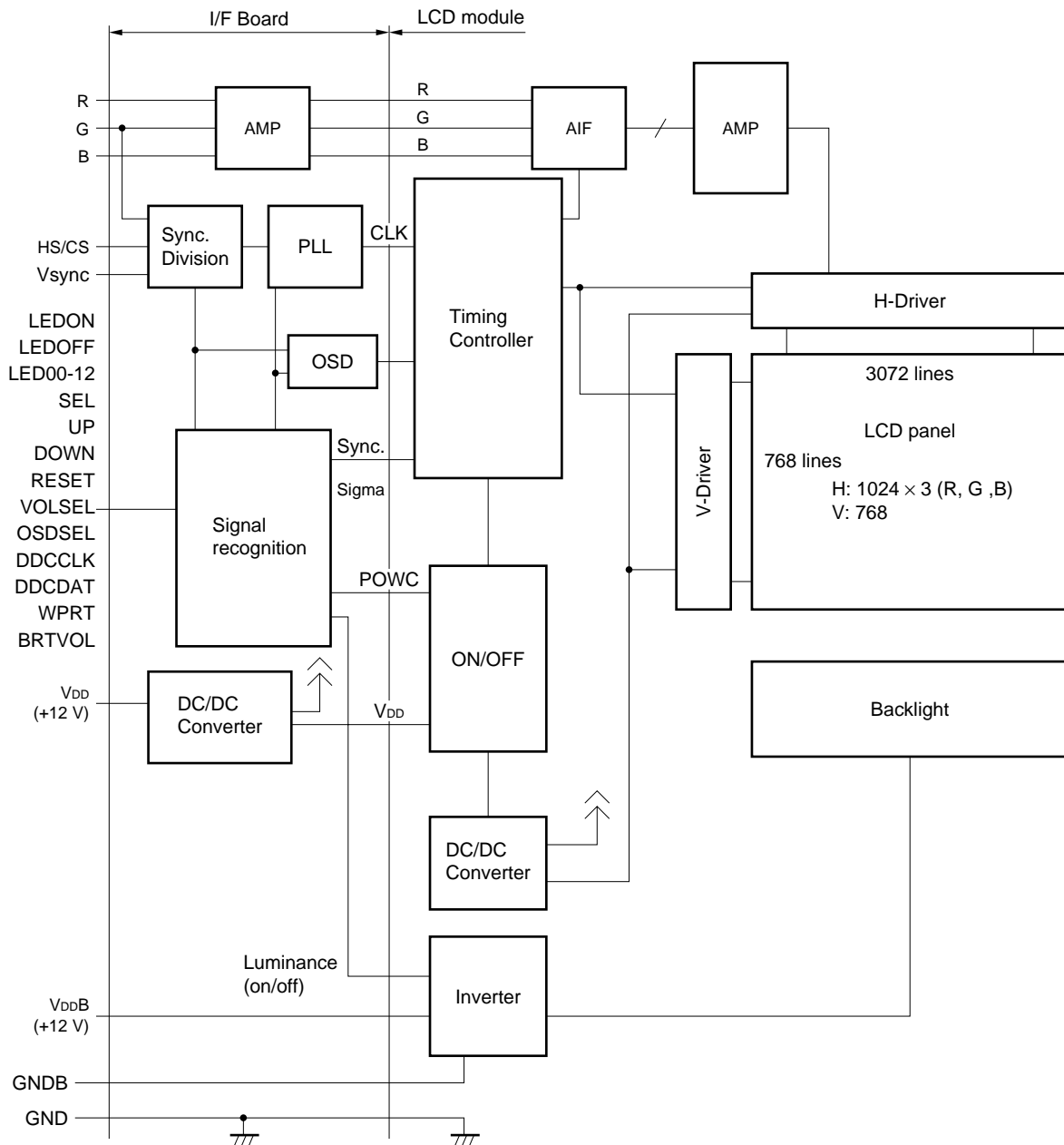

Note Frame is not connected to GND nor GNDB.

OUTLINE OF CHARACTERISTICS (at room temperature)

| | |
|--|---|
| Display area | 304.128 (H) × 228.096 (V) mm |
| Drive system | a-Si TFT active matrix |
| Display colors | Full-color |
| Number of pixels | 1024 × 768 |
| Pixel arrangement | RGB vertical stripe |
| Pixel pitch | 0.297 (H) × 0.297 (V) mm |
| Module size | 350.0 (H) × 265.0 (V) × 23.0 (D) mm (typ.) |
| Weight | 1480 g (typ.) |
| Contrast ratio | 150:1 (typ., perpendicular) |
| Viewing angle (more than the contrast ratio of 10:1) | <ul style="list-style-type: none">• Horizontal: 85° (typ., left side, right side)• Vertical : 85° (typ., up side, down side) |
| Optimum grayscale | perpendicular ($\gamma = 2.2$) |
| Polarizer pencil-hardness | 3H (min., JISK5400) |
| Color gamut | 48 % (typ., At center, To NTSC) |
| Response time | 44 ms (typ.), "black" to "white" |
| Luminance | 180 cd/m ² (typ.) |
| Input signals | Analog RGB, Vsync and HS |
| Backlight | Edge light type: Four cold cathode fluorescent lamps with an inverter <Replacement parts> Inverter P/N: 150PW011 Lamp holder set P/N: 150LHS01 |
| Supply voltage | 12 V (typ.), 12 V (typ.) |
| Power consumption | 24.7 W (typ.) |

GENERAL SPECIFICATIONS

| Item | Contents | Unit |
|-------------------|---|-------|
| Module size | 350.0 ± 0.6 (H) × 265.0 ± 0.6 (V) × 24.0 (max.) (D) | mm |
| Display area | 304.128 (H) × 228.096 (V) | mm |
| Number of dots | 1024 × 3 (H) × 768 (V) | dots |
| Pixel pitch | 0.297 (H) × 0.297 (V) | mm |
| Dot pitch | 0.099 (H) × 0.297 (V) | mm |
| Pixel arrangement | RGB (Red, Green, Blue) vertical stripe | – |
| Display colors | Full color | color |
| Weight | 1,480 (typ.), 1600 (max.) | g |

ABSOLUTE MAXIMUM RATINGS

| Parameter | Symbol | Rating | Unit | Remarks |
|-------------------------------|---|---------------|------|-------------------------------------|
| Supply voltage | V _{DD} | –0.3 to + 14 | V | Ta = 25°C |
| | V _{DDB} | –0.3 to + 14 | V | |
| Logic input voltage | V _{IN1} | –0.3 to + 5.5 | V | Ta = 25°C V _{DD} = 12 V |
| R, G, B input voltage | V _{IN2} | –6.0 to + 6.0 | V | |
| CLK input voltage | V _{IN3} | –7.0 to + 7.0 | V | |
| Storage temp. | T _{ST} | –20 to + 60 | °C | – |
| Operating temp. | T _{OP} | 0 to 50 | °C | Module surface Note 1 |
| Humidity (no condensation) | ≤ 95% relative humidity | | | Ta ≤ 40°C |
| | ≤ 85% relative humidity | | | 40 < Ta ≤ 50°C |
| | Absolute humidity shall not exceed Ta = 50°C, 85% relative humidity level. | | | Ta > 50°C |

- Notes** 1. Measured at the LCD panel (Include own fever)
 2. No condensation

ELECTRICAL CHARACTERISTICS

(1) Logic, LCD driving, Backlight

(Ta = 25°C)

| Item | Symbol | Min. | Typ. | Max. | Unit | Remarks |
|---|-------------------|------|------|------|------|--|
| Supply voltage | V _{DD} | 11.4 | 12.0 | 12.6 | V | Logic and LCD driving |
| | V _{DD} B | 11.4 | 12.0 | 12.6 | V | Backlight |
| Logic input "L" voltage | V _{IL} | 0 | – | 0.8 | V | HS/CS, Vsync, SEL, UP, DOWN, RESET, VOLSEL, DDCCLK, DDCDAT, OSDSEL, WPRT |
| Logic input "H" voltage | V _{IH} | 2.2 | – | 5.25 | V | |
| Logic output "L" voltage | VOL1 | – | – | 0.4 | V | LED00/01/02/10/11/12 |
| Logic output "H" voltage | VOH1 | 2.4 | – | – | V | |
| Logic input "L" current 1 | I _{iL1} | –1 | – | – | μA | HS/CS, Vsync |
| Logic input "H" current 1 | I _{iH1} | – | – | 1 | μA | |
| Logic output "L" current 1 | I _{oL1} | – | – | 1 | μA | DDCDAT |
| Logic output "H" current 1 | I _{oH1} | –1 | – | – | μA | |
| Supply current (Dot-checked pattern) | I _{DD} | – | 660 | 850 | mA | V _{DD} = 12.0 V Note1 |
| | | – | 45 | 65 | mA | Power saving mode V _{DD} = 12.0 V Note1 |
| | I _{DD} B | – | 1400 | 1600 | mA | V _{DD} B = 12.0 V (Max. luminance) |
| | | – | 1 | 10 | mA | Power saving mode V _{DD} B = 12.0 V |

Note Pixel checkered pattern

(2) Video signal (R, G, B) input

(Ta = 25°C)

| Item | Min. | Typ. | Max. | Unit | Remarks |
|-----------------------------------|--------------|----------------|------|------|-------------------------------|
| Maximum amplitude (white - black) | 0 (black) | 0.7 (white) | *A | Vp-p | Note |
| DC input level (black) | –0.5 | – | +2.5 | V | – |
| Sync level | 0.2 | 0.3 | *B | Vp-p | G terminal (sync on green) |
| *A + *B | – | – | 1.1 | Vp-p | |

Note Need to adjust contrast if the input level is beyond 0.7 Vp-p.

POWER SUPPLY DESIGN

(1) Ripple voltage of the supply voltage

Please note that the ripple at the input connector of the module should be within the values shown in this table. If the ripple would be beyond these values, the noise might appear on the screen.

| | V _{DD} (for logic and LCD driver) | V _{DD} B (for backlight) |
|------------------|---|--------------------------------------|
| Acceptable range | ≤ 100 mVp-p | ≤ 200 mVp-p |

Note The acceptable range of ripple voltage includes spike noises.

Example of the power supply connection to minimize the ripple voltage

a) Separate the power supply

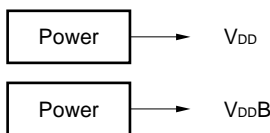

b) Put the filter

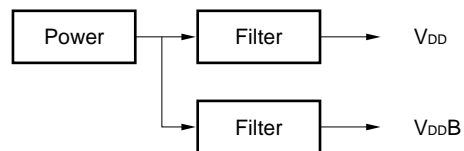

(2) Current wave in the luminance control mode

In the luminance control mode, the rush current below flows into the inverter of the module. The duty cycle varies from 100% through 20% depending on the luminance control level. This might cause the noise on the screen. Please evaluate the appropriate value of the capacitor in the filter to eliminate the noise.

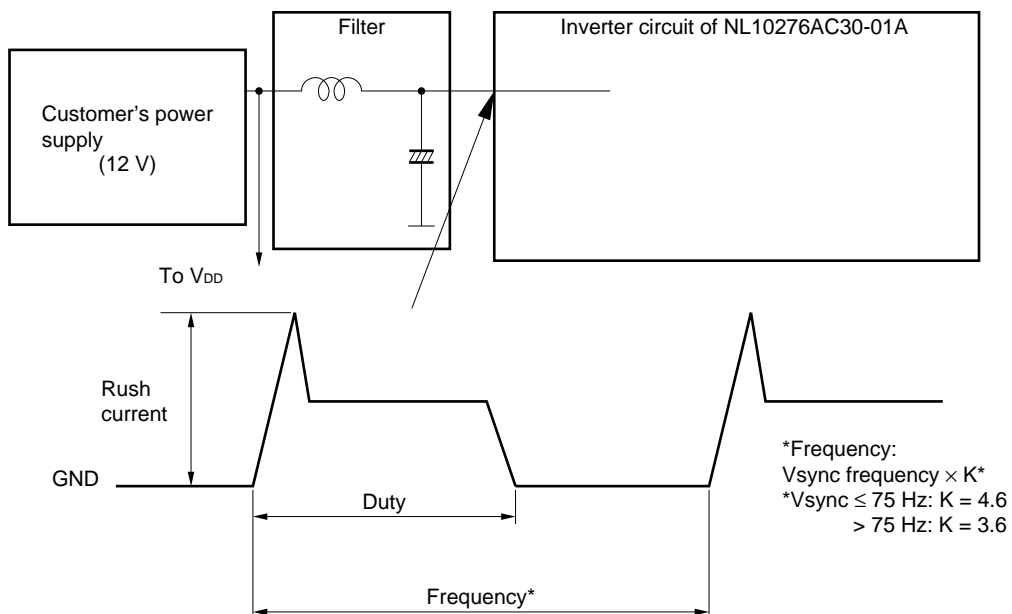

POWER SUPPLY SEQUENCE

There is no sequence among the synchronous signals, the video signals and the power supply. However, 12 V for backlight should be started up within 80 ms, otherwise, the protection circuit makes the backlight turns off.

Please note that the supply voltage must not be applied while the control signals (SEL, UP, DOWN and RESET) are connected to GND. Otherwise the module may cause malfunctions.

If the power supply voltage is applied while SEL and RESET is connected to GND, the mode is set into NEC factory mode. In this case, both LEDON and LEDOFF become “H”. Please do not use the module in this mode which may write over the default value. Please turn off the power supply immediately and turn on the power while SEL and RESET are connected to GND again. If the default value has been revised by accident, please follow the instruction below.

<NEC factory mode>

This mode can control Brightness and Contrast and OSD position. Factory Reset function is reset all values. But do not use the module in this mode which may write over the default values affect to the LCD internal operation. Please turn off the power immediately and turn on the power while SEL and RESET are connected to GND again. If the default value has been revised by accident, please select “Factory Reset” mode and press “Reset” key for over two seconds.

| Functions | Control contents | How to reset |
|---------------|---|---------------------------------|
| Brightness | Total Brightness and Sub Brightness for each RGB | Press RESET key over 2 seconds |
| Contrast | Total Contrast and Sub Contrast for each RGB | Press RESET key over 2 seconds |
| LCD Data | Never select and adjust values | Please go to the Factory reset. |
| Color adjust | | |
| VCO | | |
| HDTV Select | | |
| OSD position | Change the OSD display position | – |
| Factory Reset | Above function values is reset to factory values. | Press Reset key over 2 seconds. |
| RESET | RESET the NEC factory mode | – |

INTERFACE AND PIN CONNECTION

(1) Interface signals, power supply

CN101

Part No. : 1-353119-4

Adaptable socket : 1-353068-04

Supplier : Japan AMP Ltd.

| Pin No. | Symbol | Pin No. | Symbol |
|---------|--------|---------|--------|
| 1 | B | 8 | Vsync |
| 2 | B-GND | 9 | GND |
| 3 | G | 10 | HS/CS |
| 4 | G-GND | 11 | GND |
| 5 | R | 12 | DDCCLK |
| 6 | R-GND | 13 | N.C. |
| 7 | GND | 14 | DDCDAT |

Figure from socket view



Note N.C. (No connection) should be open.

CN103

Part No. : DF14A-25P-1.25H

Adaptable socket : DF14-25S-1.25C

Supplier : HIROSE ELECTRIC CO., LTD.

| Pin No. | Symbol | Pin No. | Symbol |
|---------|--------|---------|--------|
| 1 | LEDON | 14 | RESET |
| 2 | LEDOFF | 15 | GND |
| 3 | GND | 16 | BRTVOL |
| 4 | LED00 | 17 | GND |
| 5 | LED01 | 18 | VOLSEL |
| 6 | LEDD02 | 19 | OSDSEL |
| 7 | LED10 | 20 | WPRT |
| 8 | LED11 | 21 | N.C. |
| 9 | LED12 | 22 | N.C. |
| 10 | GND | 23 | GND |
| 11 | SEL | 24 | N.C. |
| 12 | UP | 25 | N.C. |
| 13 | DOWN | | |

Figure from socket view

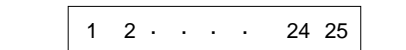

Note N.C. (No connection)

CN104

Part No. : IL-Z-8PL-SMTY

Adaptable socket : IL-Z-8S-S125C3

Supplier : Japan Aviation Electronics Industry Limited (JAE)

| Pin No. | Symbol | Pin No. | Symbol |
|---------|-----------------|---------|--------|
| 1 | V _{DD} | 5 | GND |
| 2 | V _{DD} | 6 | GND |
| 3 | V _{DD} | 7 | GND |
| 4 | V _{DD} | 8 | GND |

Figure from socket view

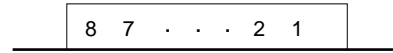

CN201

Part No. : IL-Z-11PL1-SMTY

Adaptable socket : IL-Z-11S-S125C3

Supplier : Japan Aviation Electronics Industry Limited (JAE)

| Pin No. | Symbol | Pin No. | Symbol |
|---------|-------------------------------|---------|--------|
| 1 | V _{DD} B | 7 | N.C. |
| 2 | V _{DD} B | 8 | N.C. |
| 3 | V _{DD} B | 9 | N.C. |
| 4 | G _N D _B | 10 | N.C. |
| 5 | G _N D _B | 11 | N.C. |
| 6 | G _N D _B | | |

Figure from socket view

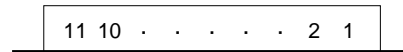

Note N.C. (No connection) should be open.

Rear view

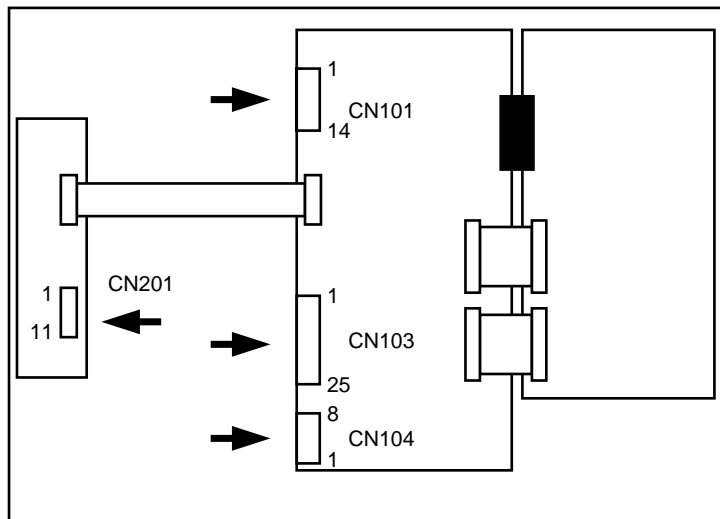

(2) Pin function

| Symbol | I/O | Logic | Description |
|--------|------------------|----------|---|
| HS/CS | Input | Negative | Horizontal synchronous signal or composite synchronous signal (TTL level), Positive/Negative auto recognition |
| Vsync | Input | Negative | Vertical synchronous signal (TTL level) Positive/Negative auto recognition, Clock input for DDC1 |
| R | Input | – | Red video signal (0.7 Vp-p, 75 Ω) |
| G | Input | – | Green video signal (0.7 Vp-p, 75 Ω), Sync On Green input |
| B | Input | – | Blue video signal (0.7 Vp-p, 75 Ω) |
| LEDON | Output | Positive | Output terminal to light up LED “H”: Power on “L”: Power off |
| LEDOFF | Output | Positive | Output terminal to light up LED “H”: Power save mode “L”: Normal mode |
| LED00 | Output | Positive | For details, see Equivalent circuit for LED and CONTROL FUNCTIONS |
| LED01 | Output | Positive | |
| LED02 | Output | Positive | |
| LED10 | Output | Negative | |
| LED11 | Output | Negative | |
| LED12 | Output | Negative | |
| DDCCLK | Input | Positive | CLK for DDC2B |
| DDCDAT | Input/ Output | Positive | Data for DDC1/2B Read/write |
| SEL | Input | Negative | Select signal for control functions (TTL level) “open”: SEL off, “L”: SEL on For details, see CONTROL FUNCTIONS |
| UP | Input | Negative | Control signal (TTL level) UP increases the value of the functions selected. “open”: UP off, “L”: UP on |
| DOWN | Input | Negative | Control signal (TTL level) DOWN reduces the value of the functions selected. “open”: DOWN off, “L”: DOWN on |
| RESET | Input | Negative | Control signal (TTL level) RESET initializes the selected functions. “open”: RESET off “L”: RESET on |
| BRTVOL | Input | – | Luminance control terminal For details, see. Luminance control select |
| VOLSEL | Input | – | Luminance control select signal (TTL level) VOLSEL is pulled up in the module. For details, see Luminance control select |
| OSDSEL | Input | – | Display select signal (TTL level) “open”: OSD display off (light on LED) “L”: OSD display on (light off LED) For details, see CONTROL FUNCTIONS |
| WPRT | Input | Positive | Select signal for DDC “Open”: Reading mode, “L”: Writing mode |

| Symbol | I/O | Logic | Description |
|-------------------|-----|-------|--|
| V _{DD} | – | – | Power supply for Logic and LCD driving +12 V (±5%) |
| V _{DD} B | – | – | Power supply for backlight. +12 V (±5%) ^{Note2} |
| GND | – | – | Ground for system. ^{Note1} |
| GNDB | – | – | Ground for backlight. ^{Note1} |

Notes 1: Ground for frame, system (GND) and backlight (GNDB) are not connected in the module.

2: 12 V for backlight should be started up within 80 ms, otherwise, the protection circuit makes the backlight turns off.

(3) LUMINANCE CONTROL SELECT

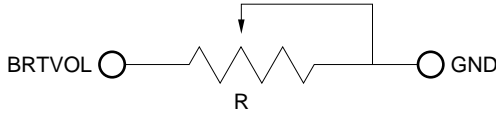
| VOLSEL = | “L” | “Open” |
|---------------|------------------------------|--|
| Form | Digital adjust | Volume adjust |
| How to adjust | See CONTROL FUNCTIONS | <p>The variable resistor for luminance control should be 10 kΩ type, and zero point of the resistor corresponds to the minimum of luminance.</p>  <p>Maximum luminance (100%): R = 10 KΩ Minimum luminance (20%): R = 0 Ω Matching variable resistor: 10 KΩ ±5%, B curve, 1/10 W</p> |

Note The status of VOLSEL is valid when the power is switched on.

(4) FUNCTION DISPLAY SELECT

| OSDSEL = | “L” | “Open” |
|---------------|------------------------------|--|
| Form | OSD Display | LED Display |
| How to adjust | See CONTROL FUNCTIONS | See detail of recommendation circuit diagram. Note: Next page |

Note The status of OSDSEL is valid when the power is switched on.

Regarding the use of OSD, please note that there is possibility of conflicts with a patent in Europe and the U.S.

Thus, if such conflict might happen when you use OSD, we shall not be responsible for any trouble.

(5) EQUIVALENT CIRCUIT FOR LEDs

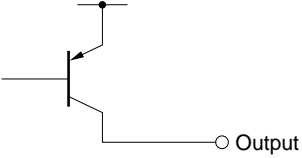
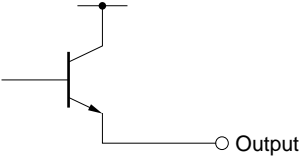
| Symbol | I/O | Equivalent circuit |
|--|--------|---|
| LEDON LEDOFF LED00 LED01 LED02 | Output | RN2306 (Toshiba) Or equivalent  |
| LED10 LED11 LED12 | Output | N-ch Open-drain Output  |

<Example of LED circuit>

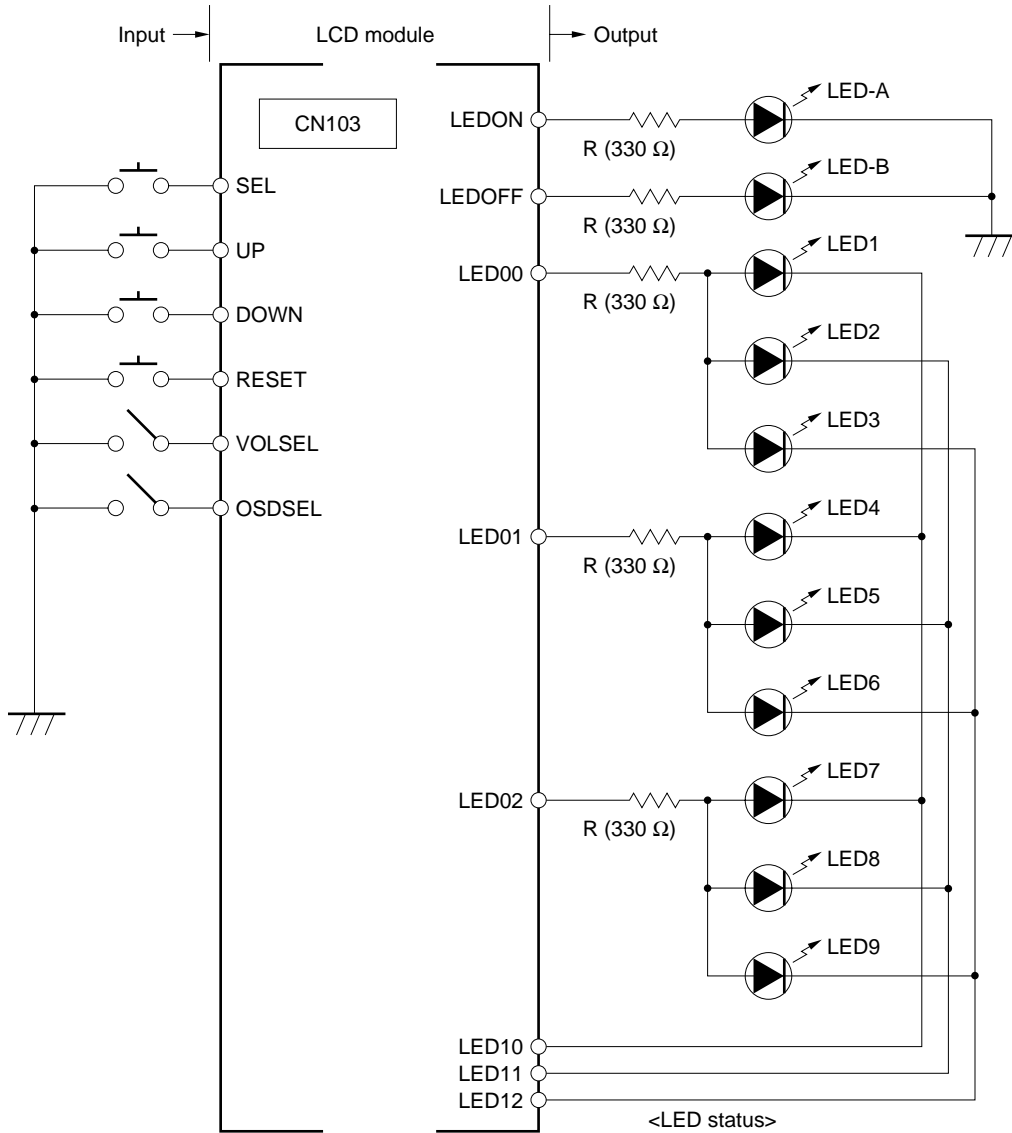

- LED-A: Power on
- LED-B: Power-save mode
- LED1: Luminance
- LED2: Contrast
- LED3: Horizontal display period
- LED4: CLK delay
- LED5: Vertical position
- LED6: Horizontal position
- LED7: Reserve
- LED8: All reset
- LED9: Reserve

INPUT SIGNALS

(1) SYNCHRONOUS SIGNAL

This module is corresponding to the synchronous signals below.

| Auto recognition mode | Synchronous signal | | |
|--|--------------------|----------|-------------------|
| | HS/CS | Vsync | Sync. On Green |
| Separate synchronous signal mode (HS, Vsync) | Input | Input | Input or no input |
| Composite synchronous mode | Input | No input | Input or no input |
| Sync. On Green mode | No input | No input | Input |
| Power save mode | No input | No input | No input |

Note Power save mode corresponds to VESA DPMA.

(2) PRESET TIMINGS

The fourteen kinds of timings below are already programmed in this module. The input synchronous signals are automatically recognized.

| Preset No. | Display size | Dot CLK (MHz) | Hsync (kHz) | Vsync (Hz) | Remark |
|------------|--------------|---------------|-------------|------------|----------------------|
| 1 | 640 × 400 | 21.053 | 24.830 | 56.432 | NEC PC98 |
| 2 | 640 × 480 | 25.175 | 31.469 | 59.992 | VGA |
| 3 | 720 × 400 | 28.322 | 31.469 | 70.087 | VGA TXT |
| 4 | 800 × 600 | 40.000 | 37.879 | 60.317 | VESA |
| 5 | 640 × 480 | 30.240 | 35.000 | 66.667 | Macintosh |
| 6 | 640 × 480 | 31.500 | 37.500 | 75.000 | VESA |
| 7 | 720 × 400 | 35.500 | 37.927 | 85.039 | VESA |
| 8 | 640 × 480 | 36.000 | 43.269 | 85.008 | VESA ^{Note} |
| 9 | 1024 × 768 | 65.000 | 48.363 | 60.004 | VESA |
| 10 | 800 × 600 | 49.500 | 46.875 | 75.000 | VESA |
| 11 | 832 × 624 | 57.283 | 49.735 | 74.565 | Macintosh |
| 12 | 800 × 600 | 56.250 | 53.674 | 85.061 | VESA ^{Note} |
| 13 | 1024 × 768 | 75.000 | 56.476 | 70.069 | VESA |
| 14 | 1024 × 768 | 78.750 | 60.023 | 75.029 | VESA |

Note Out of specification.

Even if the preset timing is entered, a little adjustment of the functions such as Horizontal period, CLK-delay and display position, are required. The adjusted values are memorized in every preset No.

This module recognizes the synchronous signals with near preset timing of the frequency of HS, Vsync, even in the case that the signals other than the preset timing that were entered. For instance, it is displayed with presetting number 6 in the case of 640 × 480 dot, HS: 37.861 kHz, Vsync: 72.809 Hz an example).

Adopt the evaluation, because adjustment may not fit, in the case that the magnifying ratio differs, in the case that you use it with except for the display timing that was preset.

(3) EXPANSION MODE

Expansion mode is a function to expand the screen size in different resolutions. For example, VGA signal has 640 × 480 pixels. But, if the display data can be expanded to 1.6 times vertically and horizontally, VGA screen image can be displayed fully on the screen of XGA resolution. This module automatically recognizes the timing shown in item 7.7.2 as an expansion mode.

Please adopt this mode after evaluating display quality, because the appearance in the expansion mode is happened to become bad in some cases.

The followings show the display magnifications in each mode.

| Input display | Number of pixels | Magnification | |
|---------------|------------------|---------------|------------|
| | | Vertical | Horizontal |
| XGA | 1024 × 768 | 1 | 1 |
| SVGA | 800 × 600 | 1.25 | 1.25 |
| VGA | 640 × 480 | 1.6 | 1.6 |
| VGA text | 720 × 400 | 1.6 | 1.4 |
| PC9801 | 640 × 400 | 1.6 | 1.6 |
| MAC | 832 × 624 | 1.2 | 1.2 |

<DISPLAY IMAGE>

1) SVGA mode (800 × 600)

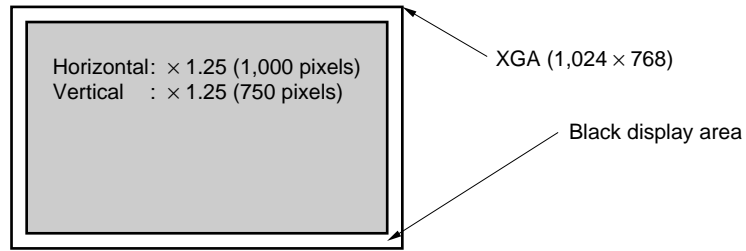

2) VGA mode (640 × 480)

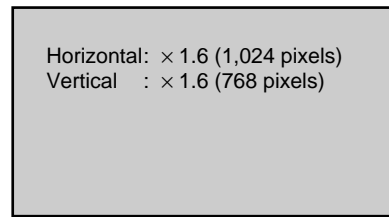

3) PC9801 mode (640 × 400)

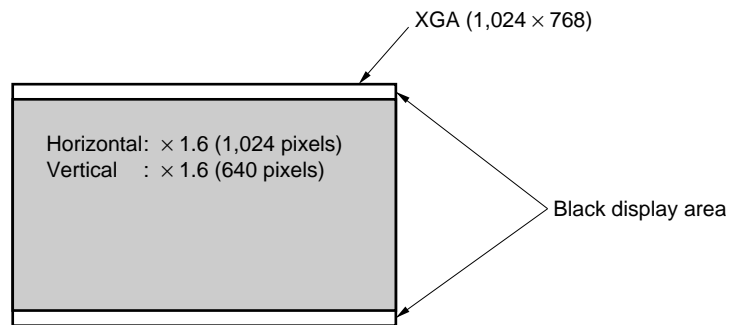

4) VGA text mode (720 × 400)

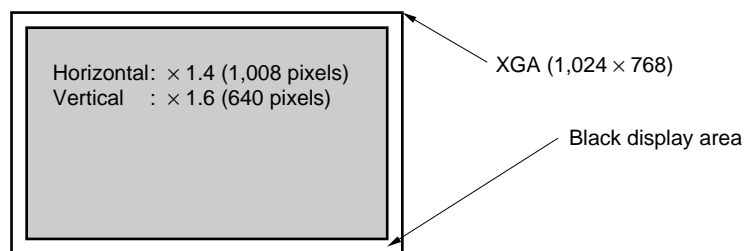

5) 832 × 624 MAC mode (832 × 624)

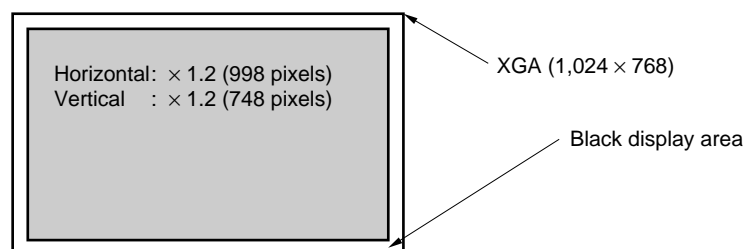

(4) DDC FUNCTION

This function is corresponding to VESA DDC™ and EDID™ (Structure Version 1).

- Writing mode : WPRT = “L”
- Reading mode: WPRT = “H” or Open

Note When the power is applied while RESET and UP are “L”, it becomes a writing mode. When the power is applied again, it becomes a reading mode. The mode set by RESET and UP signals is prioritized rather than WPRT signal after the power switched on.

Please write a data into necessary addresses in advance when you use this function. Data “55H” in address “00H” and “FFH” in other address are already programmed when shipping. The input equivalent circuit diagram is as follow.

EDID: Extended Display Identification Data

<Internal circuit diagram>

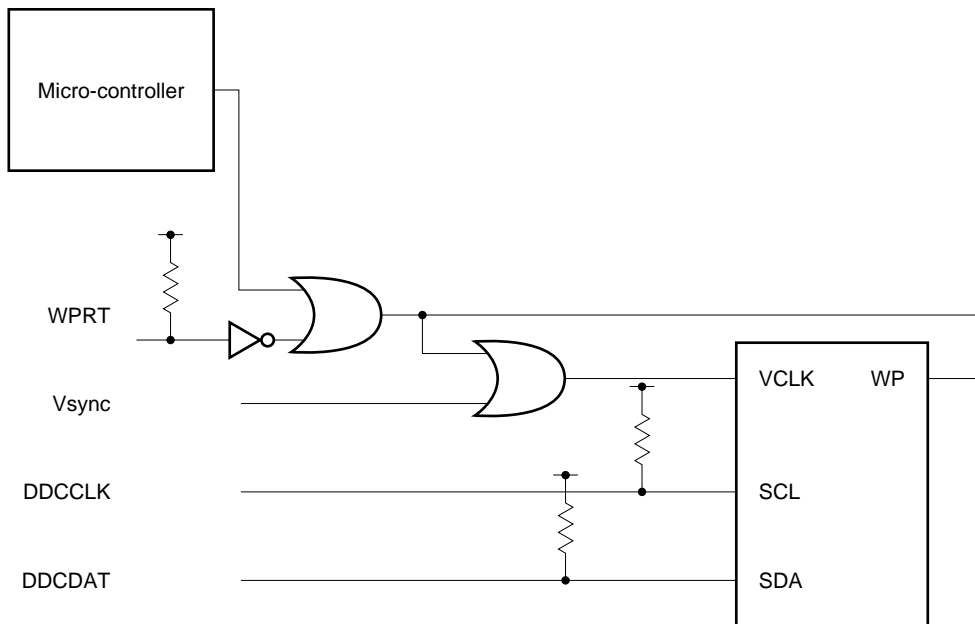

Product: Microchip Technology Inc.
24LCS21
or equivalent

(5) DPMS

| VESA DPMS Standard | | | | | NL10276AC30-01A | | |
|--------------------|------------|-----------|---------|--------------|------------------|--------------|----------------|
| State | Signal | | | Power saving | Recovery time | Power saving | Recovery time |
| | Horizontal | Vertical | Video | | | | |
| On | Pulses | Pulses | Active | None | Not applicable | None | Not applicable |
| Stand-by | No pulses | Pulses | Blanked | Minimum | Short | Maximum | Short |
| Suspend | Pulses | No pulses | Blanked | Substantial | Longer | Maximum | Short |
| Off | No pulses | No pulses | Blanked | Maximum | System dependent | Maximum | Short |

CONTROL FUNCTIONS

- 1. Brightness (Luminance) : Control luminance of backlight
- 2. Contrast : Control white-level of video signal
- 3. Horizontal display period : Adjust horizontal display period
- 4. CLK delay : Adjust CLK-phase
- 5. Vertical position : Adjust vertical position
- 6. Horizontal position : Adjust horizontal position
- 7. ALL RESET : Reset to factory-default value

In order to achieve the best picture quality, the above functions should be adjusted by setting SEL, UP, DOWN and RESET signals. Either LED or OSD can recognize the selected functions. Each adjusted value is memorized as soon as SEL is selected or time out mode is valid and the memorized values are not affected even if the power is switched off. But the selected value is not memorized in case that a selected mode is changed to another one before time out or power is turned off before time out. Regarding the luminance, the luminance value can not be memorized while the variable volume register is selected.

This function does not work while the power save mode.

(1) SELECTION BY LED

The selected functions can be indicated either LED or OSD (On Screen Display) by setting OSDSEL signal when the power switched on.

OSDSEL = "H or OPEN": LED
 OSDSEL = "L" : OSD

Please see the example of LED circuit on P 11.

| Selection function | LED00 | LED01 | LED02 | LED10 | LED11 | LED12 |
|-------------------------------|-------|-------|-------|-------|-------|-------|
| Default (no-select condition) | L | L | L | H | H | H |
| Luminance | H | L | L | L | H | H |
| Contrast | H | L | L | H | L | H |
| Horizontal display period | H | L | L | H | H | L |
| CLK delay | L | H | L | L | H | H |
| Vertical position | L | H | L | H | L | H |
| Horizontal position | L | H | L | H | H | L |
| Reserve (no-use) | L | L | H | L | H | H |
| All reset | L | L | H | H | L | H |
| Reserve (no-use) | L | L | H | H | H | L |

(2) SELECTION BY OSD

The following pictures appear on the screen by pushing the SEL key. Adjust the each value in best position by pushing UP and DOWN key.

1) Brightness (Luminance)



2) Contrast



3) Horizontal display period



4) CLK delay



5) Vertical display position



6) Horizontal display position



7) All reset



(3) FLOW CHART OF CONTROL FUNCTIONS FOR SEL, UP, DOWN AND RESET

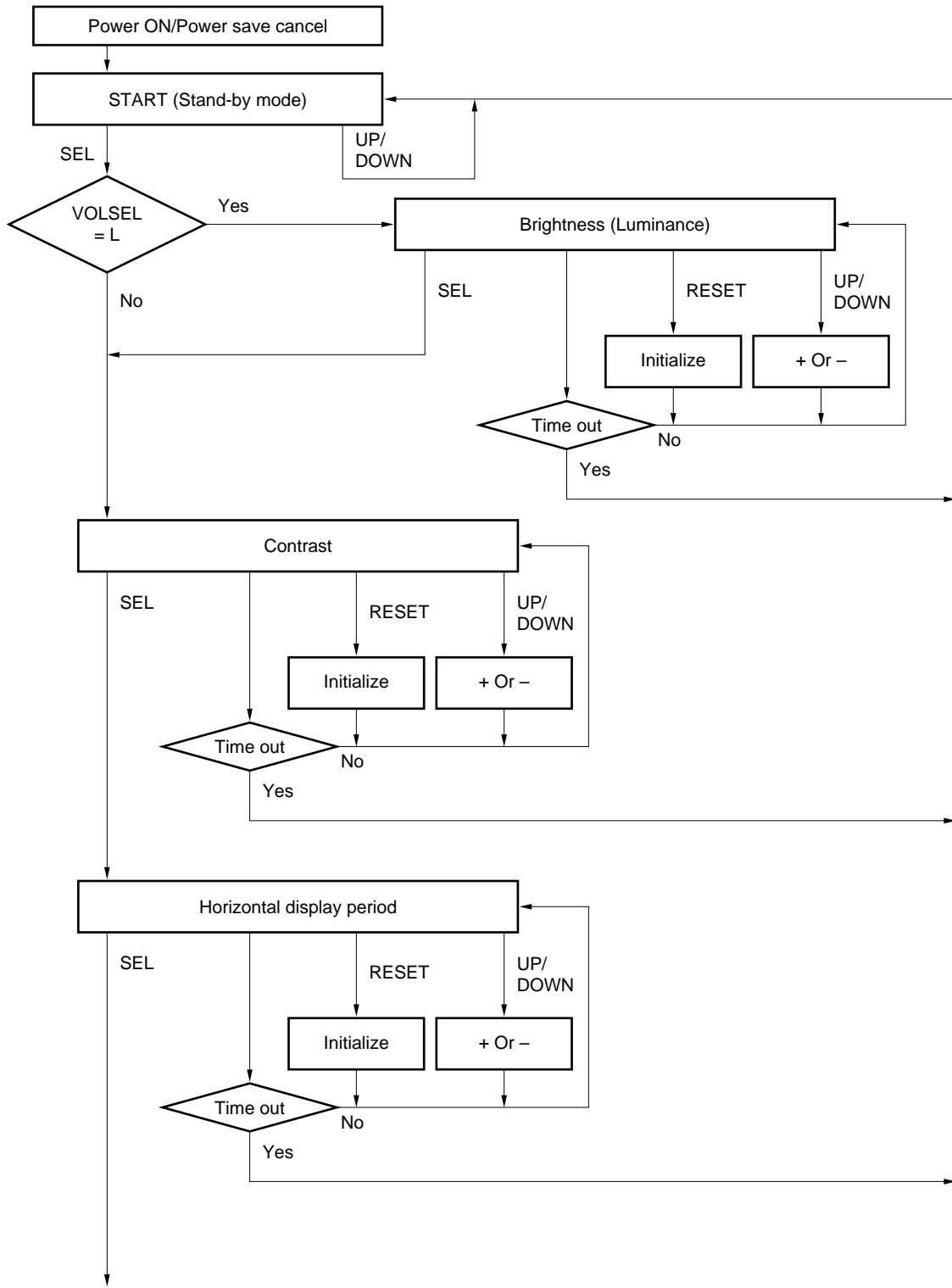

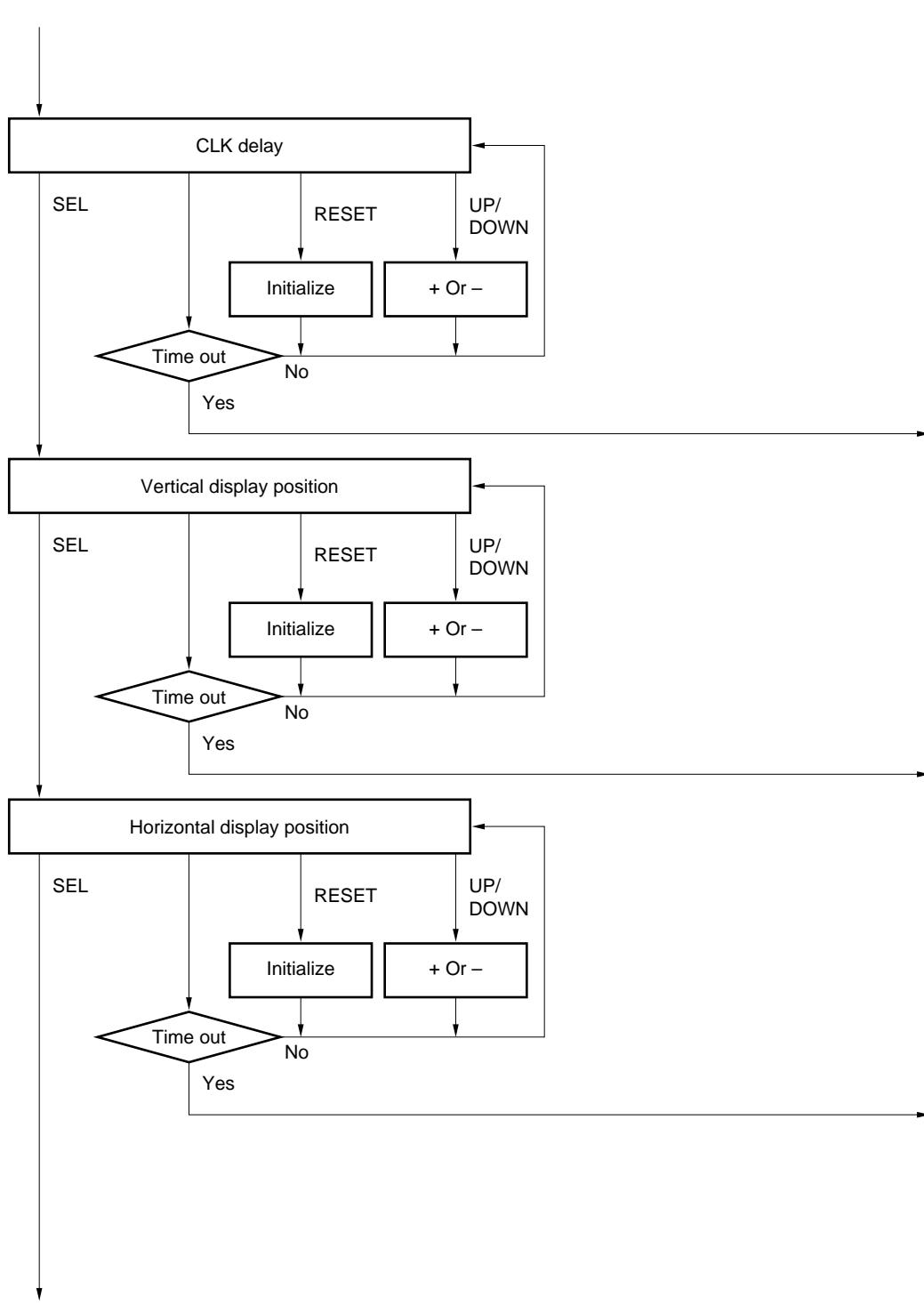

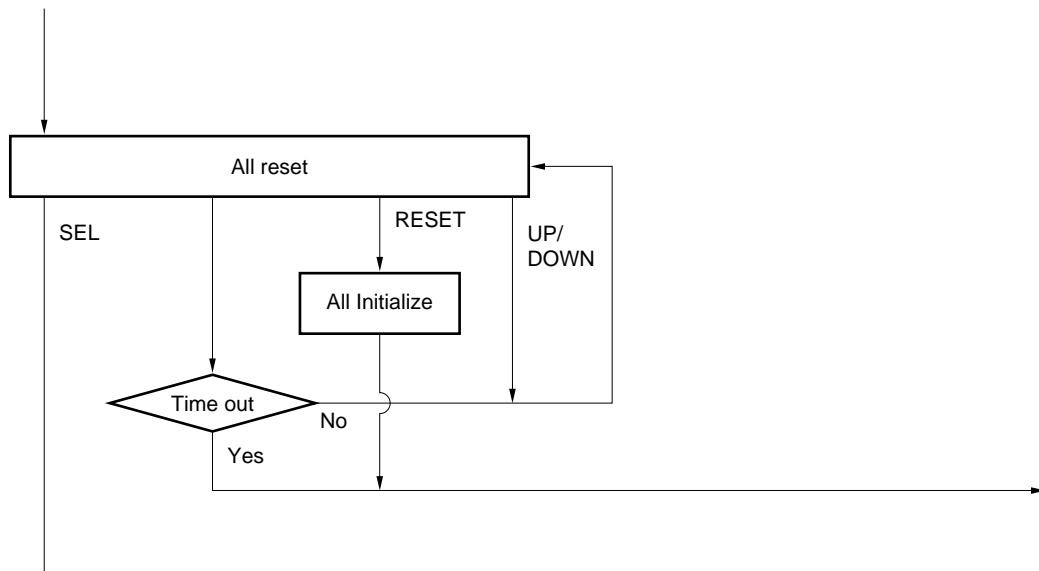

- Notes**
1. The value of the selected signals by UP and DOWN key is continuously incremented if the input signal is held more than approx. one second. If it's less than one second, the value is incremented by one.
 2. RESET signal initializes the value selected by SEL key. All reset function initializes all the values adjusted already. RESET signal should be held more than approx. two seconds.
 3. No key input for more than five seconds shall be regarded "Time out".

OPTICAL CHARACTERISTICS

($T_a = 25^\circ\text{C}$, $V_{DD} = 12\text{ V}$, $V_{DDB} = 12\text{ V}$)

| Item | Symbol | Condition | Min. | Typ. | Max. | Unit | Remarks |
|----------------------|--------|--|------|------|------|-------------------|---------------|
| Contrast ratio | CR | $\gamma = 2.2$ viewing angle $\theta_R = 0^\circ$, $\theta_L = 0^\circ$, $\theta_D = 0^\circ$, White/Black, at center | 100 | 150 | – | – | Note 1 |
| Luminance | Lvmax | White, at center | 150 | 180 | – | cd/m ² | Note 2 |
| Luminance uniformity | – | White | – | 1.1 | 1.30 | – | Note 3 |

Reference data

($T_a = 25^\circ\text{C}$, $V_{DD} = 12\text{ V}$, $V_{DDB} = 12\text{ V}$)

| Item | Symbol | Condition | Min. | Typ. | Max. | Unit | Remark |
|-------------------------|------------|---|------|----------|------|------|---------------|
| Color gamut | C | $\theta_R = 0^\circ$, $\theta_L = 0^\circ$, $\theta_U = 0^\circ$, $\theta_D = 0^\circ$ at center, to NTSC | 35 | 48 | – | % | – |
| Viewing angle range | θ_R | $CR > 10$, $\theta_U = 0^\circ$, $\theta_D = 0^\circ$ | 70 | 85 | – | deg. | – |
| | θ_L | | 70 | 85 | – | deg. | – |
| | θ_U | $CR > 10$, $\theta_R = 0^\circ$, $\theta_L = 0^\circ$ | 70 | 85 | – | deg. | – |
| | θ_D | | 70 | 85 | – | deg. | – |
| Response time | ton | Black to White (0% → 90%) | – | 44 | 80 | ms | Note 5 |
| | toff | White to Black (100% → 10%) | – | 47 | 80 | | |
| Luminance control range | – | Maximum luminance: 100% | – | 30 - 100 | – | % | – |

Notes 1. The contrast ratio is calculated using the following formula.

$$\text{Contrast ratio (CR)} = \frac{\text{Luminance with all pixels in "white"}}{\text{Luminance with all pixels in "black"}}$$

2. The luminance is measured after 20 minutes from the module works, with all pixels in "white". The typical value is measured after luminance saturation, more than one hour after burn-in. The timing is XGA standard mode, preset No. 9

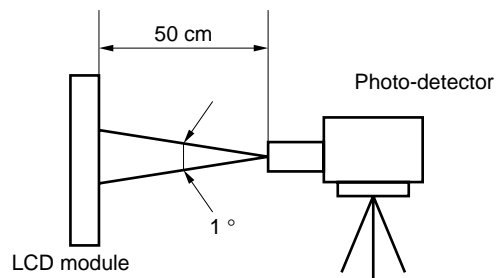

3. Luminance uniformity is calculated using the following formula.

$$\text{Luminance uniformity} = \frac{\text{Maximum luminance}}{\text{Minimum luminance}}$$

The luminance is measured at near the five points shown below.

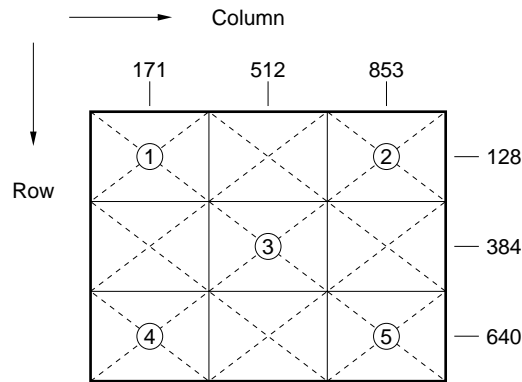

4. Definitions of viewing angle are as follows.

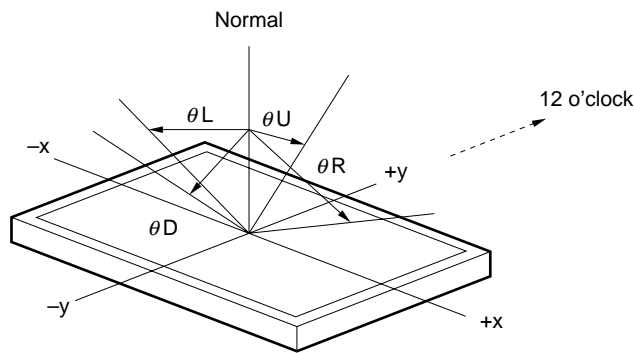

5. Definitions of response time is as follows.

Photo-detector output signal is measured when the luminance changes "white" to "black" or "black" to "white".

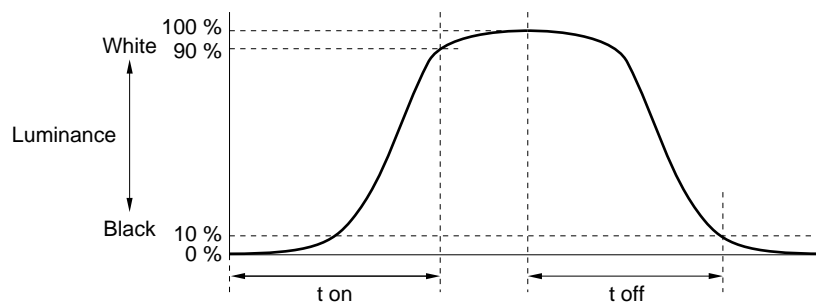

RELIABILITY TEST

| Test item | Test condition | Judgment |
|-------------------------------------|---|-------------------|
| High temperature/humidity operation | 50 ±2°C, 85% relative humidity 240 hours, Display data is white. | Note 1 |
| Heat cycle (operation) | <1> 0°C ±3°C ... 1 hour 55°C ±3°C ... 1 hour <2> 50 cycles, 4 hours/cycle <3> Display data is white. | Note 1 |
| Thermal shock (non-operation) | <1> -20°C ±3°C ... 30 minutes 60°C ±3°C ... 30 minutes <2> 100 cycles <3> Temperature transition time is within 5 minutes. | Note 1 |
| Vibration (non-operation) | <1> 5-100 Hz, 2 G 1 minute/cycle, X, Y, Z direction <2> 50 times each direction | Notes 1, 2 |
| Mechanical shock (non-operation) | <1> 55 G, 11 ms X, Y, Z direction <2> 3 times each direction | Notes 1, 2 |
| ESD (operation) | 150 pF, 150 Ω, ±10 KV 9 places on a panel Note 3 10 times each place at one-second intervals | Note 1 |
| Dust (operation) | 15 kinds of dust (JIS Z 8901) Hourly 15 seconds stir, 8 times repeat | Note 1 |

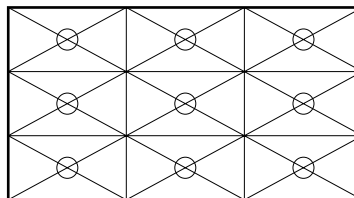

- Notes**
1. Display function is checked by the same condition as LCD module out-going inspection.
 2. Physical damage.
 3. Discharge points are shown in the figure.



GENERAL CAUTIONS

Next figures and sentence are very important. Please understand these contents as follows.

| | |
|---|---|
|  | CAUTION This figure is a mark that you will get hurt and/or the module will have damages when you make a mistake to operate. |
|---|---|

| | |
|---|---|
|  | This figure is a mark that you will get an electric shock when you make a mistake to operate. |
|  | This figure is a mark that you will get hurt when you make a mistake to operate |

 **CAUTION**

| | |
|---|--|
|  | Do not touch an inverter, on which is stuck a caution label, while the LCD module is under the operation, because of dangerous high voltage. |
|---|--|

- (1) Caution when taking out the module
 - a) Pick the pouch only, in taking out module from a carrier box.
- (2) Cautions for handling the module
 - a) As the electrostatic discharges may break the LCD module, handle the LCD module with care against electrostatic discharges.
 - b)  As the LCD panel and backlight element are made from fragile glass material, impulse and pressure to the LCD module should be avoided.
 - c) As the surface of polarizer is very soft and easily scratched, use a soft dry cloth without chemicals for cleaning.
 - d) Do not pull the interface connectors in or out while the LCD module is operating.
 - e) Put the module display side down on a flat horizontal plane.
 - f) Handle connectors and cables with care.
 - g) When the module is operating, do not lose CLK, HS, or Vsync signal. If any one of these signals is lost, the LCD panel would be damaged.
 - h) The torque to mounting screw should never exceed 0.392 N·m (4 kgf·cm).
 - i) Don't push or rub the surface of LCD module please.
If you do, the scratches or the marks like rubbing may left on the surface of the module.
- (3) Cautions for the atmosphere
 - a) Dew drop atmosphere should be avoided.
 - b) Do not store and/or operate the LCD module in a high temperature and/or high humidity atmosphere. Storage in an anti-static pouch and under the room temperature atmosphere is recommended.
 - c) This module uses cold cathode fluorescent lamps. Therefore, the life of lamps becomes short if the module is operated under the low temperature environment.
 - d) Do not operate the LCD module in a high magnetic field.
- (4) Caution for the module characteristics
 - a) Do not apply the fixed pattern for a long time to the LCD module. It may cause image sticking. Please use the screen savers if the display pattern is fixed for a long time.
 - b) This module has the retardation film which may cause the variation of the color hue in the different viewing angles. The nonuniformity may appear on the screen under the high temperature operation.
 - c) The light vertical stripe may be observed depending on the display pattern. This is not defects or malfunctions.

d) The noise from the inverter circuit may be observed in the luminance control mode. This is not defects or malfunctions.

(5) Other cautions

- a) Do not disassemble and/or reassemble LCD module.
- b) Do not readjust any variable resistors or switches in the module.
- c) When returning the module for repair or etc., please pack the module properly to avoid any damages. We recommend using the original shipping packages.
- d) In case that the scan converter is used to convert VGA signal to NTSC, it is recommended using the frame-memory type, not the line-memory.

Liquid Crystal Display has the following specific characteristics. There are not defects or malfunctions.

The optical characteristics of this module may be affected by the ambient temperature.

This module has cold cathode tube for backlight. Optical characteristics, like luminance or uniformity, will be changed by the progress in time.

Uneven brightness and/or small spots may be observed depending on different display patterns.

OUTLINE DRAWINGS: FRONT VIEW (Unit: mm)

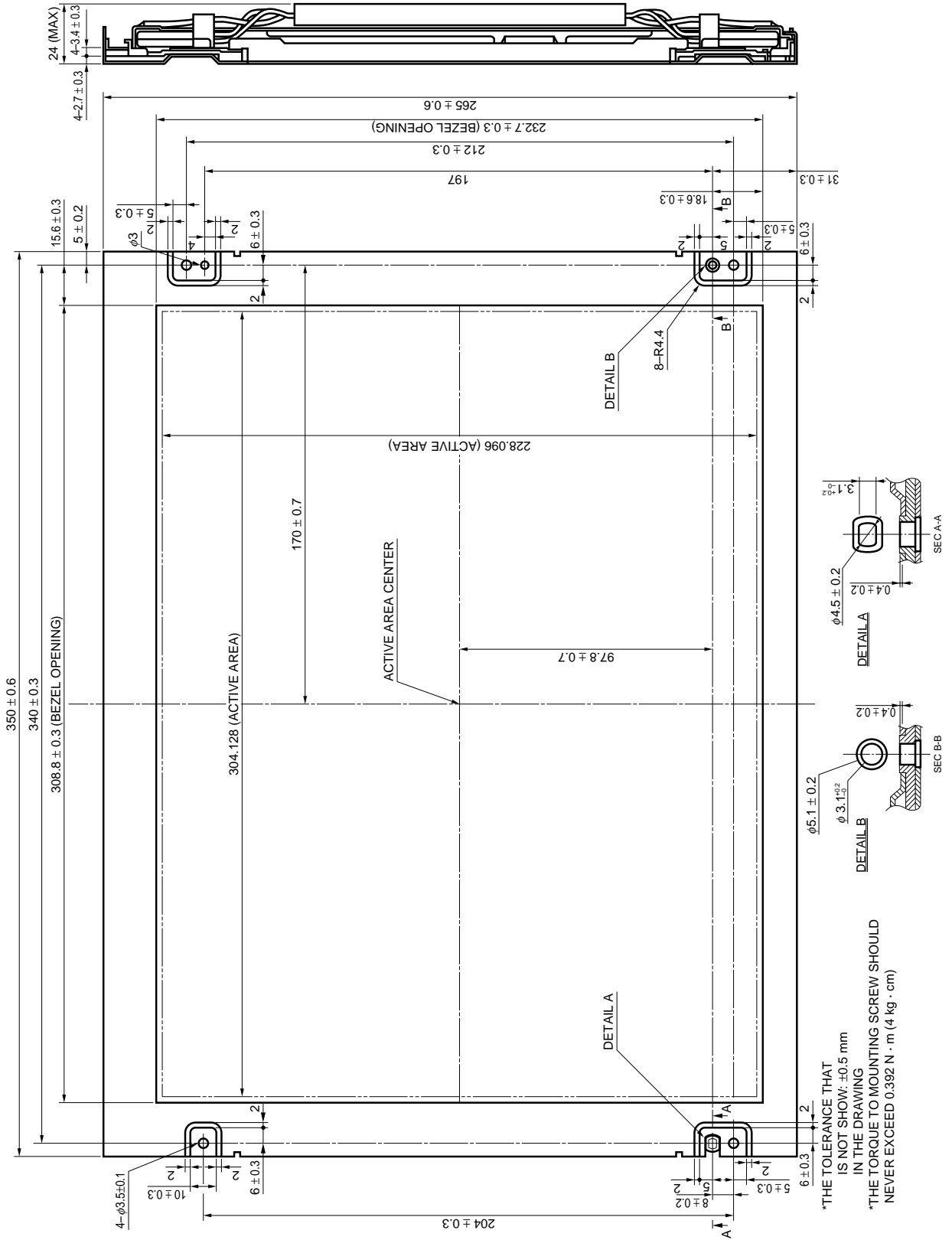

*THE TOLERANCE THAT IS NOT SHOWN: ± 0.5 mm IN THE DRAWING

*THE TORQUE TO MOUNTING SCREW SHOULD NEVER EXCEED $0.392 \text{ N} \cdot \text{m}$ ($4 \text{ kg} \cdot \text{cm}$)

OUTLINE DRAWING: REAR VIEW (Unit: mm)

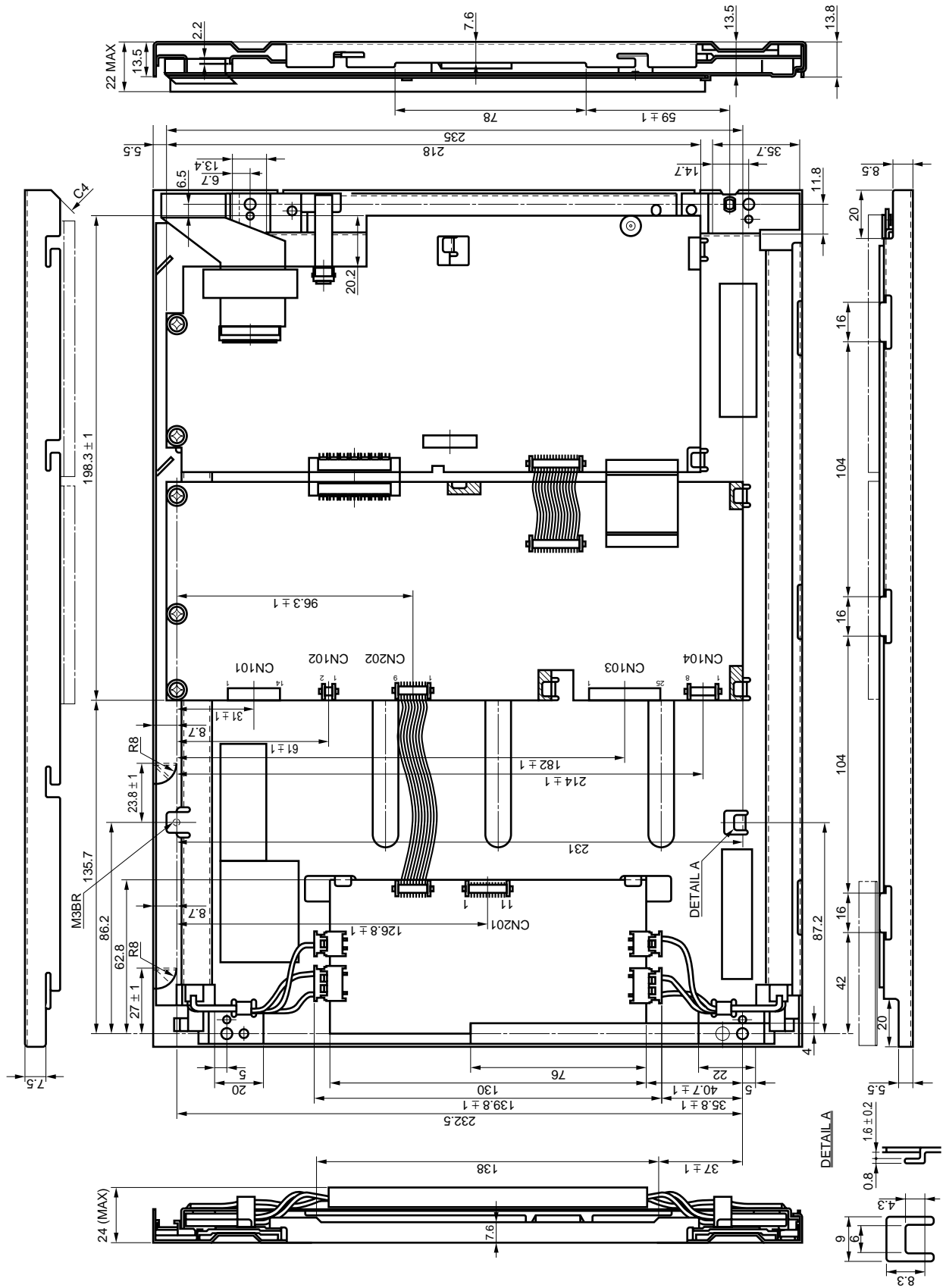

[MEMO]

[MEMO]

No part of this document may be copied or reproduced in any form or by any means without the prior written consent of NEC Corporation. NEC Corporation assumes no responsibility for any errors which may appear in this document.

NEC Corporation does not assume any liability for infringement of patents. Copyrights or other intellectual property rights of third parties by or arising from use of a device described herein or any other liability arising from use of such device. No license, either express, implied or otherwise, is granted under any patents, copyrights or other intellectual property rights of NEC Corporation or others.

While NEC Corporation has been making continuous effort to enhance the reliability of its Electronic components, the possibility of defects cannot be eliminated entirely. To minimize risks of damage or injury to persons or property arising from a defect in an NEC electronic components, customers must incorporate sufficient safety measures in its design, such as redundancy, fire-containment, and anti-failure features.

NEC devices are classified into the following three quality grades:

“Standard”, “Special”, and “Specific”. The Specific quality grade applies only to devices developed based on a customer designated “quality assurance program” for a specific application. The recommended applications of a device depend on its quality grade, as indicated below. Customers must check the quality grade of each device before using it in a particular application.

Standard: Computers, office equipment, communications equipment, test and measurement equipment, audio and visual equipment, home electronic appliances, machine tools, personal electronic equipment and industrial robots

Special: Transportation equipment (automobiles, trains, ships, etc.), traffic control systems, anti-disaster systems, anti-crime systems, safety equipment and medical equipment (not specifically designed for life support)

Specific: Aircrafts, aerospace equipment, submersible repeaters, nuclear reactor control systems, life support systems or medical equipment for life support, etc.

The quality grade of NEC devices is “Standard” unless otherwise specified in NEC’s Data Sheets or Data Books. If customers intend to use NEC devices for applications other than those specified for Standard quality grade, they should contact an NEC sales representative in advance.

Anti-radioactive design is not implemented in this product.