

GBC338

NPN SILICON TRANSISTOR

Description

The GBC338 is designed for drive and output-stages of audio amplifiers.

Features

- High DC Current Gain: 100~630 @ $V_{CE}=1V$, $I_C=100mA$
- Complementary to GBC328

Package Dimensions

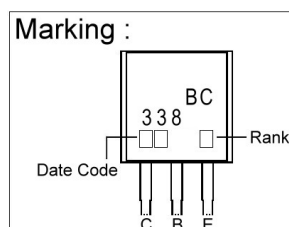
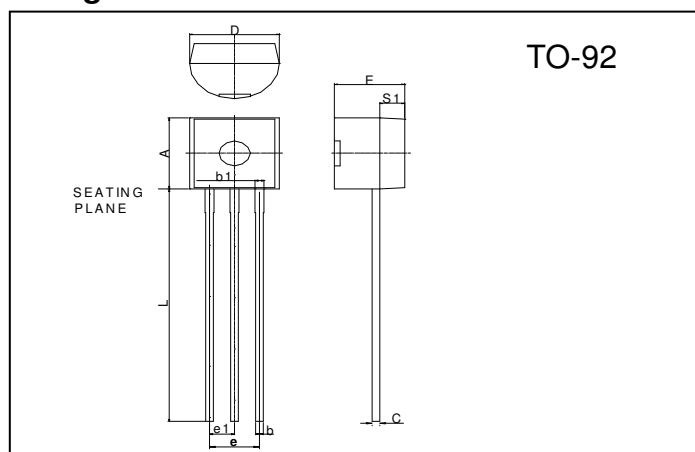

REF.	Millimeter		REF.	Millimeter	
	Min.	Max.		Min.	Max.
A	4.45	4.7	D	4.44	4.7
S1	1.02	-	E	3.30	3.81
b	0.36	0.51	L	12.70	-
b1	0.36	0.76	e1	1.150	1.390
C	0.36	0.51	e	2.42	2.66

Absolute Maximum Ratings ($T_A=25^{\circ}C$)

Parameter	Symbol	Ratings	Unit
Collector to Base Voltage	V_{CBO}	30	V
Collector to Emitter Voltage	V_{CEO}	25	V
Emitter to Base Voltage	V_{EBO}	5	V
Collector Current (continuous)	I_C	800	mA
Total Device Dissipation @ $T_A = 25^{\circ}C$	P_D	625	mW
Derate above $25^{\circ}C$		5.0	mW/ $^{\circ}C$
Total Device Dissipation @ $T_C = 25^{\circ}C$	P_D	1.5	W
Derate above $25^{\circ}C$		12	mW/ $^{\circ}C$
Operating and Storage Junction Temperature	T_J, T_{stg}	-55 ~ +150	$^{\circ}C$
Thermal Resistance, Junction to Ambient	$R_{\theta JA}$	200	$^{\circ}C/W$
Thermal Resistance, Junction to Case	$R_{\theta JC}$	83.3	$^{\circ}C/W$

Electrical Characteristics ($T_A = 25^{\circ}C$ unless otherwise noted)

Symbol	Min.	Typ.	Max.	Unit	Test Conditions
V_{CBO}	30	-	-	V	$I_C=100\mu A, I_E=0$
V_{CEO}	25	-	-	V	$I_C=10mA, I_B=0$
V_{CES}	30	-	-	V	$I_C=100\mu A, I_E=0$
V_{EBO}	5	-	-	V	$I_E=10\mu A, I_C=0$
I_{CBO}	-	-	100	nA	$V_{CB}=20V, I_E=0$
I_{CES}	-	-	100	nA	$V_{CE}=25V, V_{BE}=0$
I_{EBO}	-	-	100	nA	$V_{EB}=4V, I_C=0$
* $V_{CE(sat)}$	-	-	0.7	V	$I_C=500mA, I_B=50mA$
* $V_{BE(on)}$	-	-	1.2	V	$V_{CE}=1V, I_C=300mA$
* h_{FE1}	100	-	630		$V_{CE}=1V, I_C=100mA$
* h_{FE2}	60	-	-		$V_{CE}=1V, I_C=300mA$
fT	-	210	-	MHz	$V_{CE}=5V, I_C=10mA, f=100MHz$
Cob	-	15	-	pF	$V_{CB}=10V, I_E=0, f=1MHz$

*Pulse Test: Pulse Width $\leq 380\mu s$, Duty Cycle $\leq 2\%$

Classification Of h_{FE1}

Rank	A	B	C
Range	100 ~ 250	160 ~ 400	250 ~ 630

Characteristics Curve

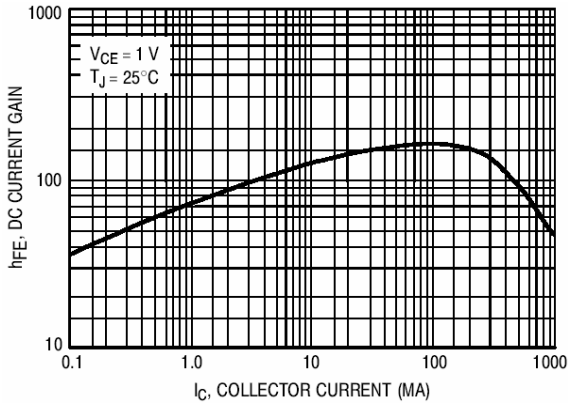

Fig 1. DC Current Gain

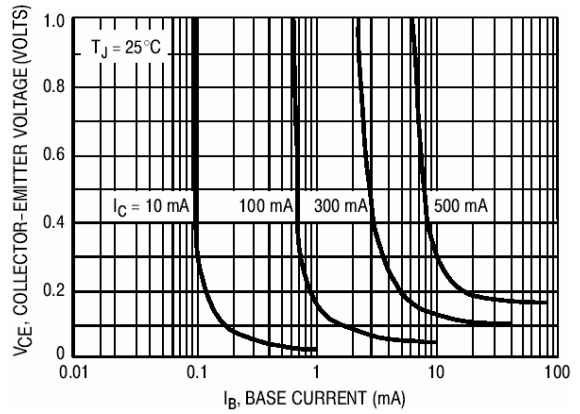

Fig 2. Saturation Region

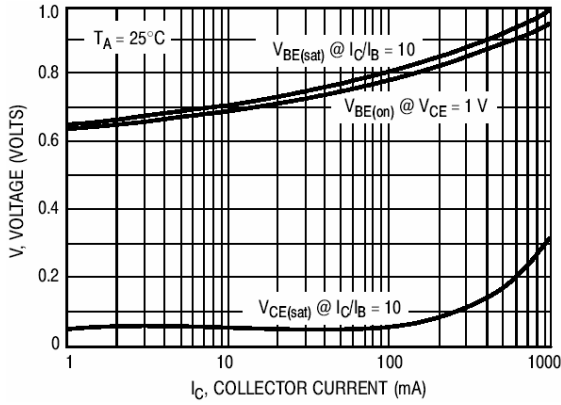

Fig 3. "On" Voltages

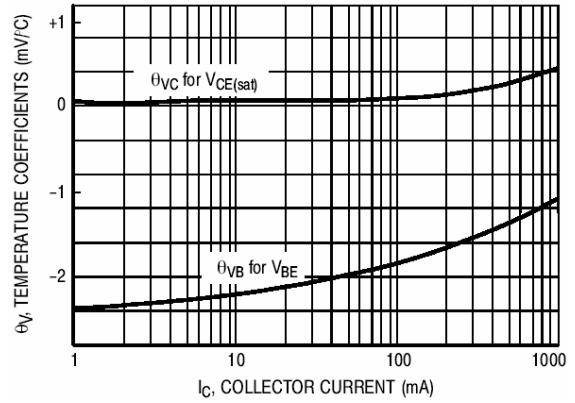

Fig 4. Temperature Coefficients

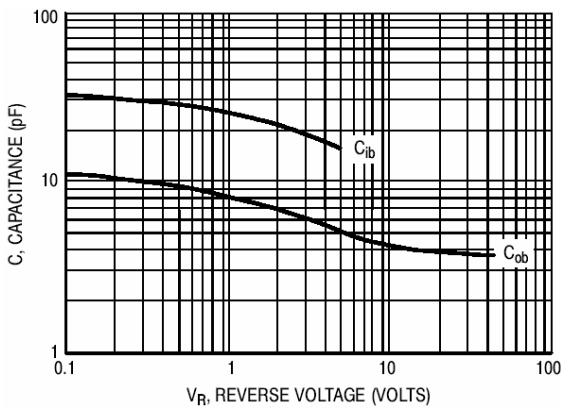

Fig 5. Capacitances

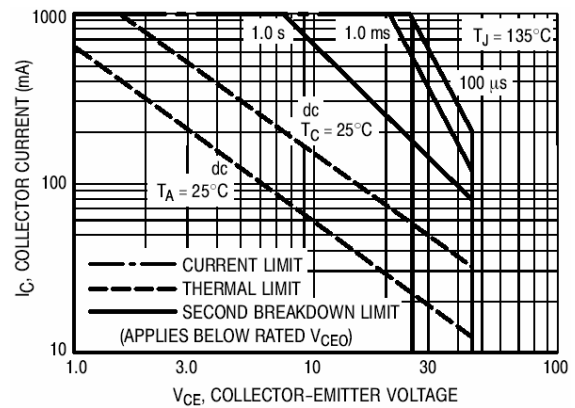

Fig 6. Safe Operating Area

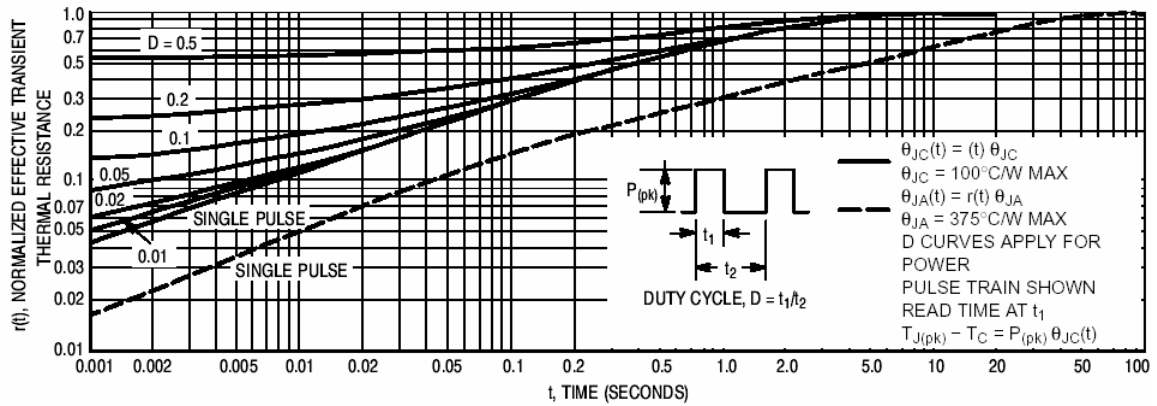

Fig 7. Thermal Response

Important Notice:

- All rights are reserved. Reproduction in whole or in part is prohibited without the prior written approval of GTM.
- GTM reserves the right to make changes to its products without notice.
- GTM semiconductor products are not warranted to be suitable for use in life-support Applications, or systems.
- GTM assumes no liability for any consequence of customer product design, infringement of patents, or application assistance.

Head Office And Factory:

- **Taiwan:** No. 17-1 Tatung Rd. Fu Kou Hsin-Chu Industrial Park, Hsin-Chu, Taiwan, R. O. C.
- TEL : 886-3-597-7061 FAX : 886-3-597-9220, 597-0785
- **China:** (201203) No.255, Jang-Jiang Tsai-Lueng RD. , Pu-Dung-Hsin District, Shang-Hai City, China
- TEL : 86-21-5895-7671 ~ 4 FAX : 86-21-38950165