

Description

The 74LVCE1G08 is a single 2-input positive AND gate with a standard totem pole output. The device is designed for operation with a power supply range of 1.4V to 5.5V. The inputs are tolerant to 5.5V allowing this device to be used in a mixed voltage environment. The device is fully specified for partial power down applications using I_{OFF}. The I_{OFF} circuitry disables the output preventing damaging current backflow when the device is powered down.

The gate performs the positive Boolean function:

$$Y = A \bullet B \text{ or } Y = \overline{\overline{A} + \overline{B}}$$

Features

- Extended Supply Voltage Range from 1.4 to 5.5V
- Switching speed characterized for operation at 1.5V
- Offers 30% speed improvement over LVC at 1.8V.
- ± 24mA Output Drive at 3.3V
- CMOS low power consumption
- IOFF Supports Partial-Power-Down Mode Operation
- Inputs accept up to 5.5V
- ESD Protection Tested per JESD 22
Exceeds 200-V Machine Model (A115-A)
Exceeds 2000-V Human Body Model (A114-A)
- Latch-Up Exceeds 100mA per JESD 78, Class II
- Range of Package Options
- Direct Interface with TTL Levels
- SOT25, SOT353, and DFN1410:
Available in "Green" Molding Compound (no Br, Sb)
- Lead Free Finish/ RoHS Compliant (Note 1)

Notes: 1. EU Directive 2002/95/EC (RoHS). All applicable RoHS exemptions applied. Please visit our website at http://www.diodes.com/products/lead_free.html.

2. Pin 2 and pin 5 of the DFN1410 package are internally connected.

Pin Assignments

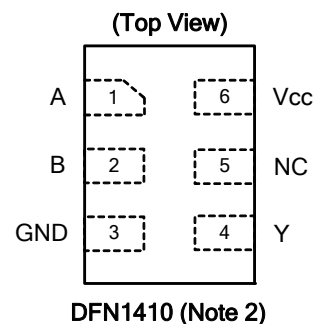
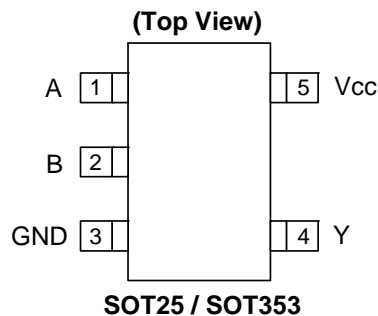

Applications

- Voltage Level Shifting
- General Purpose Logic
- Wide array of products such as.
 - PCs, networking, notebooks, netbooks, PDAs
 - Computer peripherals, hard drives, CD/DVD ROM
 - TV, DVD, DVR, set top box
 - Cell Phones, Personal Navigation / GPS
 - MP3 players ,Cameras, Video Recorders

Pin Descriptions

Pin Name	Description
A	Data Input
B	Data Input
GND	Ground
Y	Data Output
Vcc	Supply Voltage

Logic Diagram

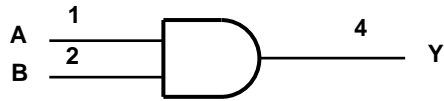

Function Table

Inputs		Output
A	B	Y
H	H	H
L	X	L
X	L	L

Absolute Maximum Ratings (Note 3)

Symbol	Description	Rating	Unit
ESD HBM	Human Body Model ESD Protection	2	KV
ESD MM	Machine Model ESD Protection	200	V
V_{CC}	Supply Voltage Range	-0.5 to 6.5	V
V_I	Input Voltage Range	-0.5 to 6.5	V
V_o	Voltage applied to output in high impedance or I_{OFF} state	-0.5 to 6.5	V
V_o	Voltage applied to output in high or low state	-0.3 to $V_{CC} + 0.5$	V
I_{IK}	Input Clamp Current $V_I < 0$	-50	mA
I_{OK}	Output Clamp Current	-50	mA
I_o	Continuous output current	± 50	mA
	Continuous current through Vdd or GND	± 100	mA
T_J	Operating Junction Temperature	-40 to 150	$^{\circ}C$
T_{STG}	Storage Temperature	-65 to 150	$^{\circ}C$

Note: 3. Stresses beyond the absolute maximum may result in immediate failure or reduced reliability. These are stress values and device operation should be within recommend values.

Recommended Operating Conditions (Note 4)

Symbol	Parameter	Min	Max	Unit	
V _{CC}	Operating Voltage	Operating	1.4	5.5	V
		Data retention only	1.2		V
V _{IH}	High-level Input Voltage	V _{CC} = 1.4 V to 1.95 V	0.65 X V _{CC}		V
		V _{CC} = 2.3 V to 2.7 V	1.7		
		V _{CC} = 3 V to 3.6 V	2		
		V _{CC} = 4.5 V to 5.5 V	0.7 X V _{CC}		
V _{IL}	Low-level input voltage	V _{CC} = 1.4 V to 1.95 V		0.35 X V _{CC}	V
		V _{CC} = 2.3 V to 2.7 V		0.7	
		V _{CC} = 3 V to 3.6 V		0.8	
		V _{CC} = 4.5 V to 5.5 V		0.3 X V _{CC}	
V _I	Input Voltage	0	5.5	V	
V _O	Output Voltage	0	V _{CC}	V	
I _{OH}	High-level output current	V _{CC} =1.4 V		-3	mA
		V _{CC} = 1.65 V		-4	
		V _{CC} = 2.3 V		-8	
		V _{CC} = 3 V		-16	
		V _{CC} = 4.5 V		-24	
I _{OL}	Low-level output current	V _{CC} =1.4 V		3	mA
		V _{CC} = 1.65 V		4	
		V _{CC} = 2.3 V		8	
		V _{CC} = 3 V		16	
		V _{CC} = 4.5 V		24	
Δt/ΔV	Input transition rise or fall rate	V _{CC} = 1.4 to 3V		20	ns/V
		V _{CC} = 3.3 V ± 0.3 V		10	
		V _{CC} = 5 V ± 0.5 V		5	
T _A	Operating free-air temperature	-40	85	°C	

Note: 4. Unused inputs should be held at V_{CC} or Ground.

Electrical Characteristics (All typical values are at $V_{CC} = 3.3V$, $T_A = 25^\circ C$)

Over recommended free-air temperature range (unless otherwise noted)

Symbol	Parameter	Test Conditions	Vcc	Min	Typ.	Max	Unit
V_{OH}	High Level Output Voltage	$I_{OH} = -100\mu A$	1.4 V to 5.5V	$V_{CC} - 0.1$			V
		$I_{OH} = -3mA$	1.4 V	1.05			
		$I_{OH} = -4mA$	1.65 V	1.2			
		$I_{OH} = -8mA$	2.3V	1.9			
		$I_{OH} = -16mA$	3 V	2.4			
		$I_{OH} = -24mA$		2.3			
		$I_{OH} = -32mA$	4.5 V	3.8			
V_{OL}	High-level Input Voltage	$I_{OL} = 100\mu A$	1.4 V to 5.5V			0.1	V
		$I_{OL} = 3mA$	1.4 V			.4	
		$I_{OL} = 4mA$	1.65 V			0.45	
		$I_{OL} = 8mA$	2.3V			0.3	
		$I_{OL} = 16mA$	3 V			0.4	
		$I_{OL} = 24mA$				0.55	
		$I_{OL} = 32mA$	4.5			0.55	
I_I	Input Current	$V_I = 5.5 V$ or GND	0 to 5.5 V			± 5	μA
I_{OFF}	Power Down Leakage Current	V_I or $V_O = 5.5V$	0			± 10	μA
I_{CC}	Supply Current	$V_I = 5.5V$ of GND $I_O = 0$	1.4 V to 5.5V			10	μA
ΔI_{CC}	Additional Supply Current	One input at $V_{CC} - 0.6 V$ Other inputs at V_{CC} or GND	3 V to 5.5V			500	μA
C_i	Input Capacitance	$V_i = V_{CC} -$ or GND	3.3		3.5		pF
θ_{JA}	Thermal Resistance Junction-to-Ambient	SOT25	(Note 5)		204		$^\circ C/W$
		SOT353	(Note 5)		371		
		DFN1410	(Note 5)		430		
θ_{JC}	Thermal Resistance Junction-to-Case	SOT25	(Note 5)		52		$^\circ C/W$
		SOT353	(Note 5)		143		
		DFN1410	(Note 5)		190		

Note: 5. Test condition for SOT25, SOT353, and DFN1410: Device mounted on FR-4 substrate PC board, 2oz copper, with minimum recommended pad layout.

Switching Characteristics

Over recommended free-air temperature range, CL = 15pF (see Figure 1)

Parameter	From (Input)	TO (OUTPUT)	Vcc = 1.5 V ± 0.1V		Vcc = 1.8 V ± 0.15V		Vcc = 2.5 V ± 0.2V		Vcc = 3.3 V ± 0.3V		Vcc = 5 V ± 0.5V		Unit
			Min	Max	Min	Max	Min	Max	Min	Max	Min	Max	
t _{pd}	A or B	Y	1.5	7.2	1.0	5	0.5	3.5	0.6	2.9	0.7	2.9	ns

Over recommended free-air temperature range, CL = 30 or 50pF as noted (see Figure 2)

Parameter	From (Input)	TO (OUTPUT)	Vcc = 1.5 V ± 0.1V		Vcc = 1.8 V ± 0.15V		Vcc = 2.5 V ± 0.2V		Vcc = 3.3 V ± 0.3V		Vcc = 5 V ± 0.5V		Unit
			Min	Max	Min	Max	Min	Max	Min	Max	Min	Max	
t _{pd}	A or B	Y	2.4	8	1.6	5.6	0.8	4.4	0.8	3.6	0.9	3.6	ns

Operating Characteristics

T_A = 25 °C

Parameter		Test Conditions	Vcc = 1.5 V	Vcc = 1.8 V	Vcc = 2.5 V	Vcc = 3.3 V	Vcc = 5 V	Unit
			TYP	TYP	TYP	TYP	TYP	
C _{pd}	Power dissipation capacitance	f = 10 MHz	21	21	24	26	31	pF

Parameter Measurement Information

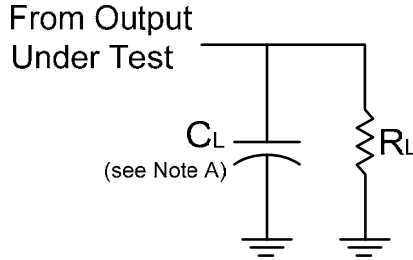

V _{CC}	Inputs		V _M	C _L	R _L
	V _I	t _r /t _f			
1.5V±0.1V	V _{CC}	≤2ns	V _{CC} /2	15pF	1MΩ
1.8V±0.15V	V _{CC}	≤2ns	V _{CC} /2	15pF	1MΩ
2.5V±0.2V	V _{CC}	≤2ns	V _{CC} /2	15pF	1MΩ
3.3V±0.3V	3V	≤2.5ns	1.5V	15pF	1MΩ
5V±0.5V	V _{CC}	≤2.5ns	V _{CC} /2	15pF	1MΩ

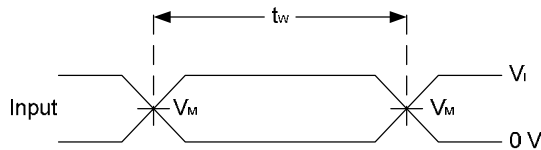

**Voltage Waveform
Pulse Duration**

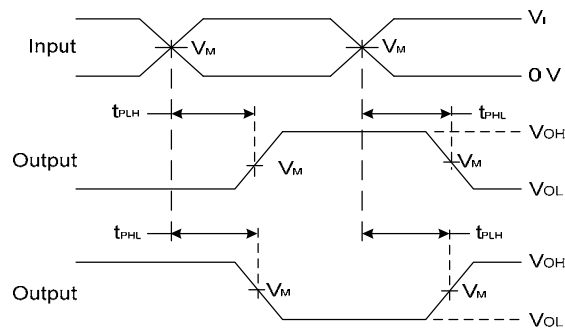

**Voltage Waveform
Propagation Delay Times
Inverting and Non Inverting Outputs**

- Notes:
- A. Includes test lead and test apparatus capacitance.
 - B. All pulses are supplied at pulse repetition rate ≤ 10 MHz.
 - C. Inputs are measured separately one transition per measurement.
 - D. t_{PLH} and t_{PHL} are the same as t_{PD} .

Figure 1. Load Circuit and Voltage Waveforms

Parameter Measurement Information (Continued)

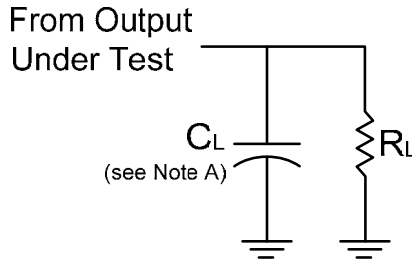

V_{CC}	Inputs		V_M	C_L	R_L
	V_I	t_r/t_f			
$1.5V \pm 0.1V$	V_{CC}	$\leq 2ns$	$V_{CC}/2$	30pF	1K Ω
$1.8V \pm 0.15V$	V_{CC}	$\leq 2ns$	$V_{CC}/2$	30pF	1K Ω
$2.5V \pm 0.2V$	V_{CC}	$\leq 2ns$	$V_{CC}/2$	30pF	500 Ω
$3.3V \pm 0.3V$	3V	$\leq 2.5ns$	1.5V	50pF	500 Ω
$5V \pm 0.5V$	V_{CC}	$\leq 2.5ns$	$V_{CC}/2$	50pF	500 Ω

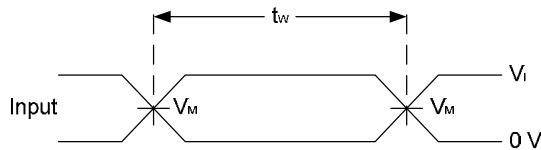

**Voltage Waveform
Pulse Duration**



**Voltage Waveform
Propagation Delay Times
Inverting and Non Inverting Outputs**

- Notes:
- A. Includes test lead and test apparatus capacitance.
 - B. All pulses are supplied at pulse repetition rate ≤ 10 MHz.
 - C. Inputs are measured separately one transition per measurement.
 - D. t_{PLH} and t_{PHL} are the same as t_{PD} .

Figure 2. Load Circuit and Voltage Waveforms

Ordering Information

74LVCE1G 08 XXX - 7

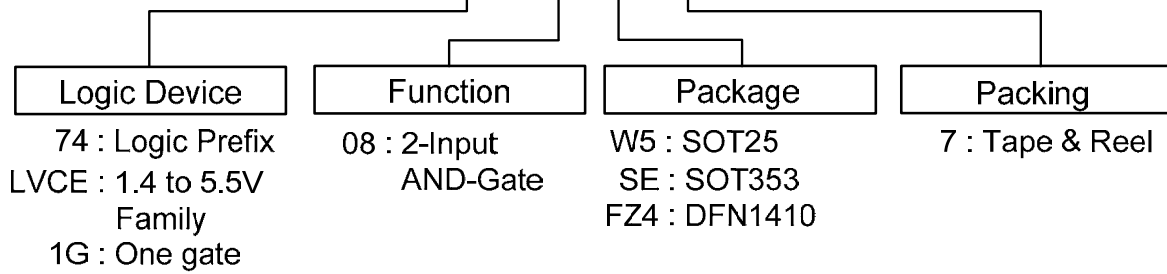

Device	Package Code	Packaging (Note 5)	7" Tape and Reel	
			Quantity	Part Number Suffix
74LVCE1G08W5-7	W6	SOT25	3000/Tape & Reel	-7
74LVCE1G08SE-7	SE	SOT353	3000/Tape & Reel	-7
74LVCE1G08FZ4-7	FZ4	DFN1410	5000/Tape & Reel	-7

Note: 6. Pad layout as shown on Diodes Inc. suggested pad layout document AP02001, which can be found on our website at <http://www.diodes.com/datasheets/ap02001.pdf>.

NEW PRODUCT

Marking Information

(1) SOT25 and SOT353

(Top View)

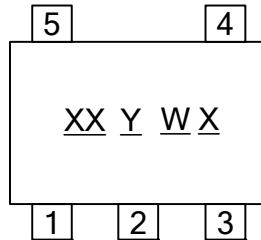

XX : Identification code
Y : Year 0~9
W : Week : A~Z : 1~26 week;
 a~z : 27~52 week; z represents
 52 and 53 week
X : A~Z : Internal code

Part Number	Package	Identification Code
74LVCE1G08W5	SOT25	PV
74LVCE1G08SE	SOT353	PU

(2) DFN1410H4-6

(Top View)

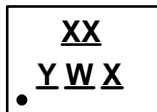

XX : Identification Code
Y : Year : 0~9
W : Week : A~Z : 1~26 week;
 a~z : 27~52 week; z represents
 52 and 53 week
X : A~Z : Internal code

Part Number	Package	Identification Code
74LVCE1G08FZ4	DFN1410	PV

Package Outline Dimensions (All Dimensions in mm)

(1) Package Type: SOT25



(2) Package Type: SOT353

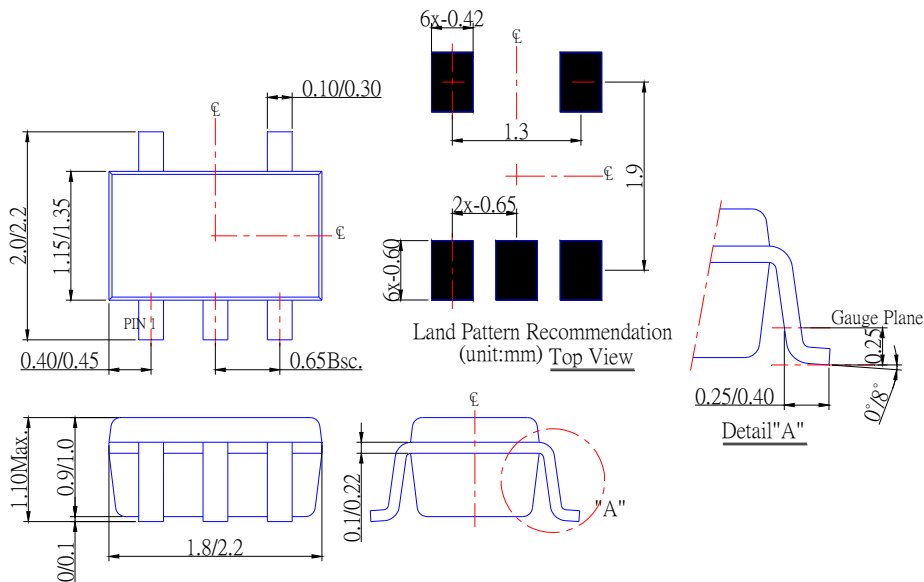

Package Outline Dimensions (All Dimensions in mm)

(3) Package Type: DFN1410

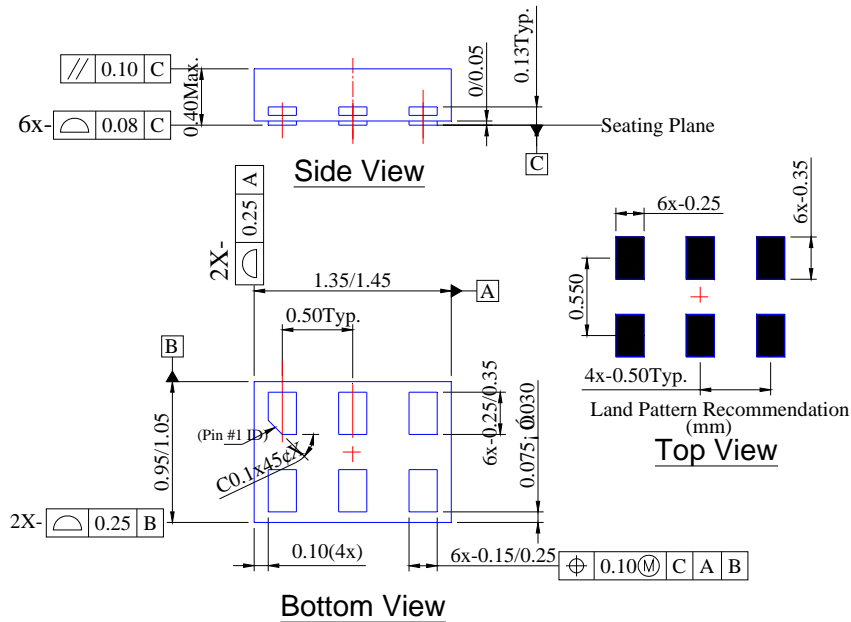

NEW PRODUCT

Taping Orientation (Note 7)

For DFN1410

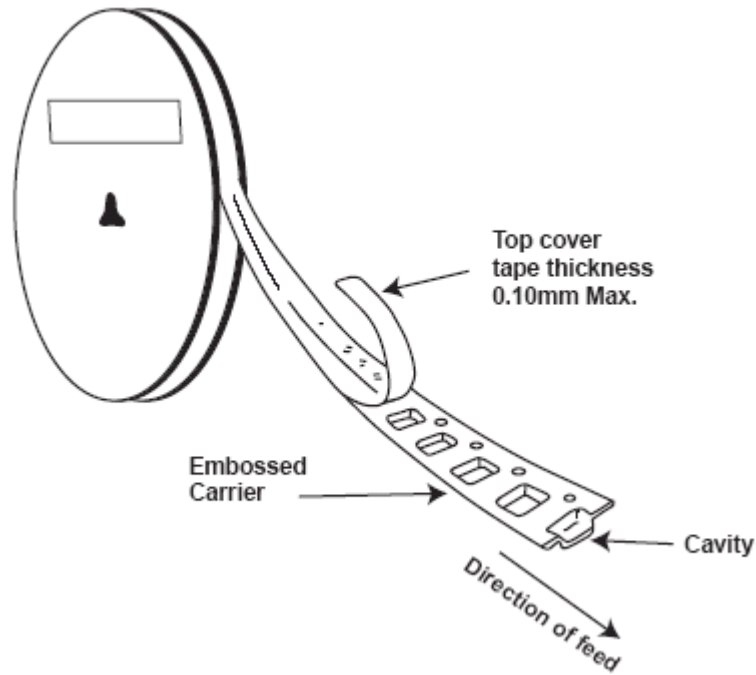
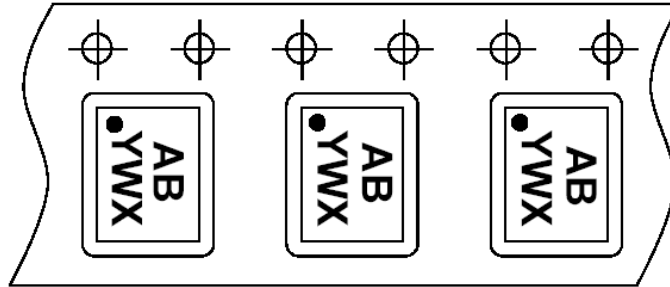

Note: 7. The taping orientation of the other package type can be found on our website at <http://www.diodes.com/datasheets/ap02007.pdf>

NEW PRODUCT

IMPORTANT NOTICE

DIODES INCORPORATED MAKES NO WARRANTY OF ANY KIND, EXPRESS OR IMPLIED, WITH REGARDS TO THIS DOCUMENT, INCLUDING, BUT NOT LIMITED TO, THE IMPLIED WARRANTIES OF MERCHANTABILITY AND FITNESS FOR A PARTICULAR PURPOSE (AND THEIR EQUIVALENTS UNDER THE LAWS OF ANY JURISDICTION).

Diodes Incorporated and its subsidiaries reserve the right to make modifications, enhancements, improvements, corrections or other changes without further notice to this document and any product described herein. Diodes Incorporated does not assume any liability arising out of the application or use of this document or any product described herein; neither does Diodes Incorporated convey any license under its patent or trademark rights, nor the rights of others. Any Customer or user of this document or products described herein in such applications shall assume all risks of such use and will agree to hold Diodes Incorporated and all the companies whose products are represented on Diodes Incorporated website, harmless against all damages.

Diodes Incorporated does not warrant or accept any liability whatsoever in respect of any products purchased through unauthorized sales channel.

Should Customers purchase or use Diodes Incorporated products for any unintended or unauthorized application, Customers shall indemnify and hold Diodes Incorporated and its representatives harmless against all claims, damages, expenses, and attorney fees arising out of, directly or indirectly, any claim of personal injury or death associated with such unintended or unauthorized application.

Products described herein may be covered by one or more United States, international or foreign patents pending. Product names and markings noted herein may also be covered by one or more United States, international or foreign trademarks.

LIFE SUPPORT

Diodes Incorporated products are specifically not authorized for use as critical components in life support devices or systems without the express written approval of the Chief Executive Officer of Diodes Incorporated. As used herein:

A. Life support devices or systems are devices or systems which:

1. are intended to implant into the body, or
2. support or sustain life and whose failure to perform when properly used in accordance with instructions for use provided in the labeling can be reasonably expected to result in significant injury to the user.

B. A critical component is any component in a life support device or system whose failure to perform can be reasonably expected to cause the failure of the life support device or to affect its safety or effectiveness.

Customers represent that they have all necessary expertise in the safety and regulatory ramifications of their life support devices or systems, and acknowledge and agree that they are solely responsible for all legal, regulatory and safety-related requirements concerning their products and any use of Diodes Incorporated products in such safety-critical, life support devices or systems, notwithstanding any devices- or systems-related information or support that may be provided by Diodes Incorporated. Further, Customers must fully indemnify Diodes Incorporated and its representatives against any damages arising out of the use of Diodes Incorporated products in such safety-critical, life support devices or systems.

Copyright © 2010, Diodes Incorporated

www.diodes.com