

# JSM Series Sub-Miniature Slide Switches

## Features/Benefits

- RoHS compliant and meets all requirements of RoHS directive 2002/95EC, Halogen Free
- Positive detent
- Low profile
- IR reflow to 260° solder profile
- Surface and thru hole mounting
- Maintained and momentary functions
- SPDT, SP3T models

## Typical Applications

- Telecommunication products
- Computer peripherals
- Thermostat select switch
- Instrumentations

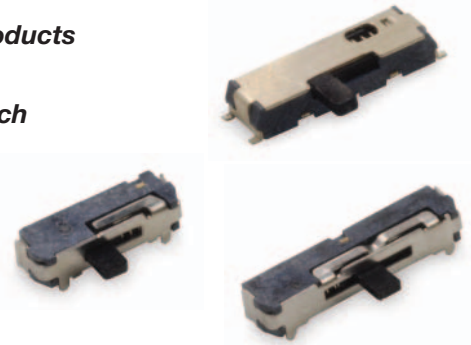

## Specifications

CONTACT RATING: 4 VDC @ 0.3A  
 ELECTRICAL LIFE: 10,000 make-and-break cycles at full load.  
 CONTACT RESISTANCE: 70 m Ω max.  
 INSULATION RESISTANCE: 100 M Ω min. @ 500V.  
 DIELECTRIC STRENGTH: 100 VAC min. @ sea level.  
 OPERATING TEMPERATURE: -10°C to +60°C  
 STORAGE TEMPERATURE: -30°C to +85°C

**NOTE:** Specifications and materials listed above are for switches with standard options. For information on specific and custom switches, consult Customer Service Center.

## Materials

HOUSING: LCP, Glass filled (Halogen free)  
 ACTUATOR: 4/6 nylon (UL94V-2), black.  
 CONTACTS: Beryllium copper, silver plated.  
 TERMINALS: Brass, silver plated.  
 COVER: Stainless steel  
 RETURN SPRING: Stainless steel

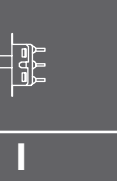

Slide

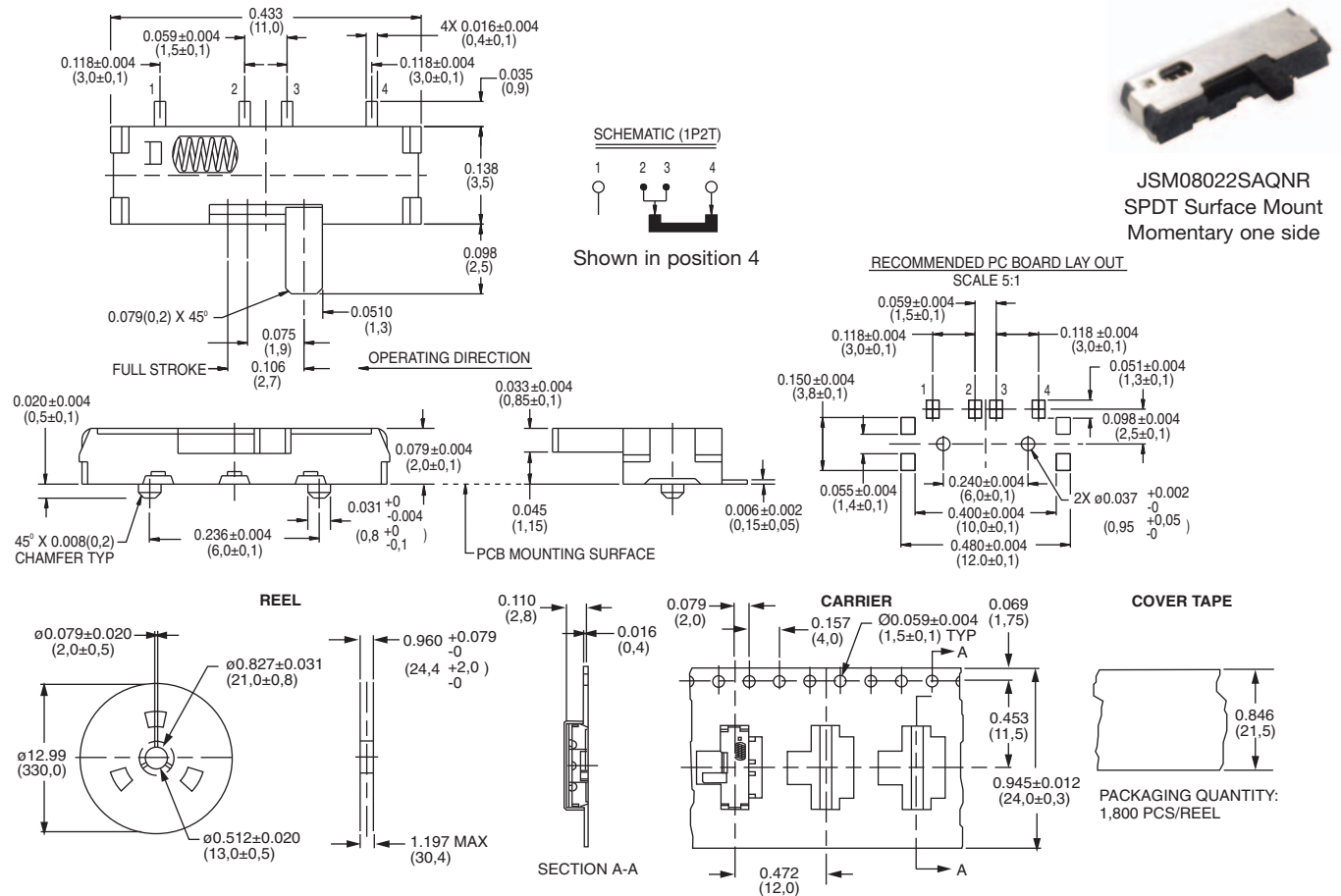

Third Angle Projection

Dimensions are shown: Inches (mm)  
 Specifications and dimensions subject to change

# JSM Series Sub-Miniature Slide Switches

Slide

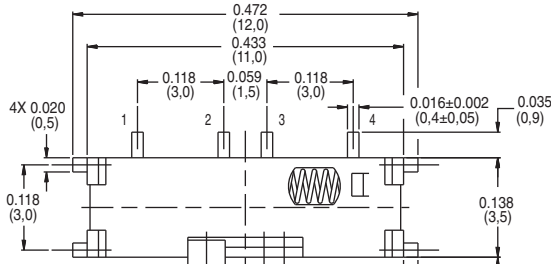

**SCHEMATIC (1P2T)**

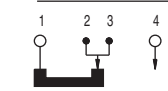

Shown in position 1



**JSM08022SAQNL**  
SPDT Surface Mount  
Momentary only

**RECOMMENDED PC BOARD LAY OUT**

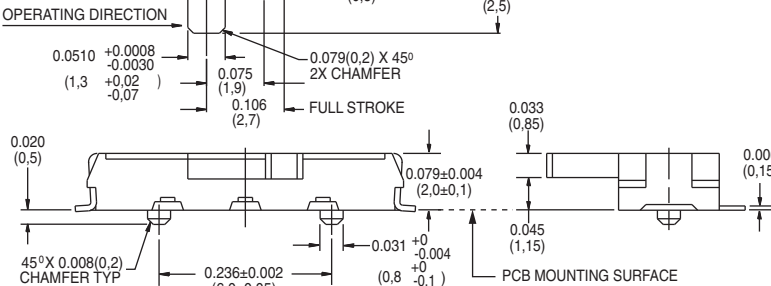
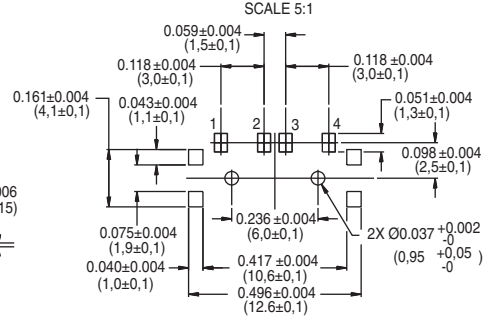

**REEL**

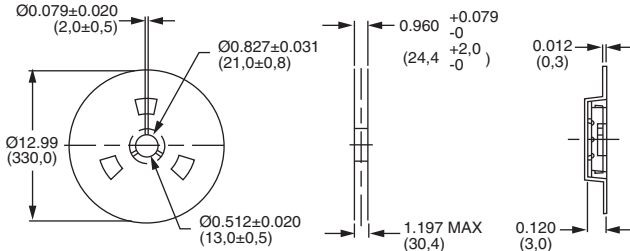

**CARRIER TAPE**

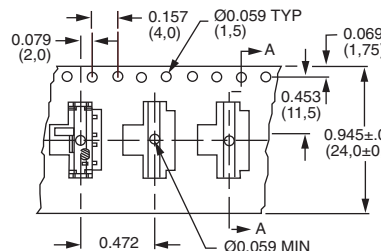

**COVER TAPE**

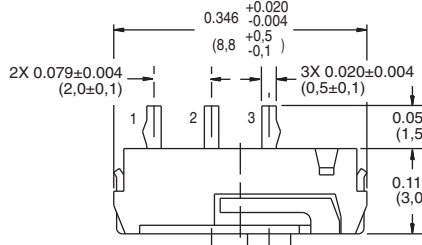
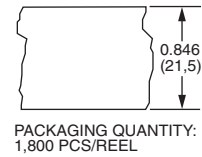

**SCHEMATIC (1P2T)**

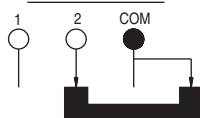

Shown in position 2



**JSM08011SAQNR**  
SPDT Surface Mount  
Momentary only

**RECOMMENDED PC BOARD LAY OUT**

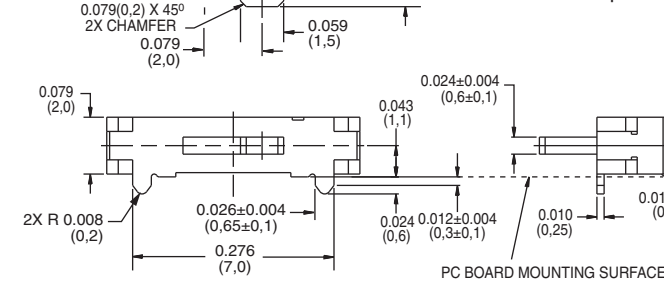
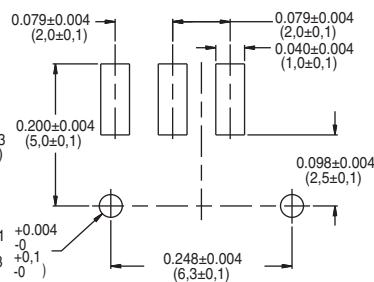

PC BOARD MOUNTING SURFACE

**REEL**

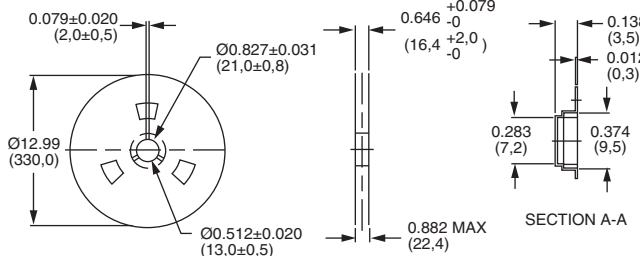

**CARRIER TAPE**

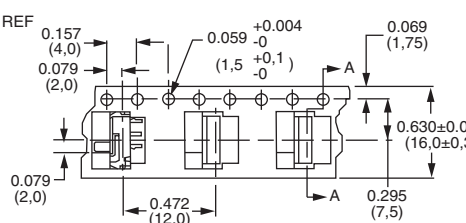

**COVER TAPE**

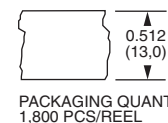

Third Angle Projection

Dimensions are shown: Inch (mm)  
Specifications and dimensions subject to change



# JSM Series Sub-Miniature Slide Switches

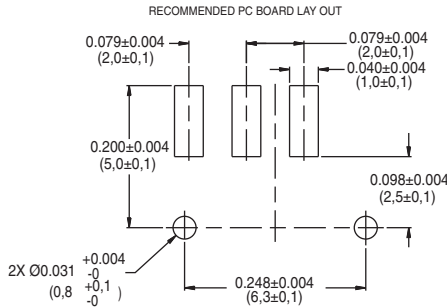
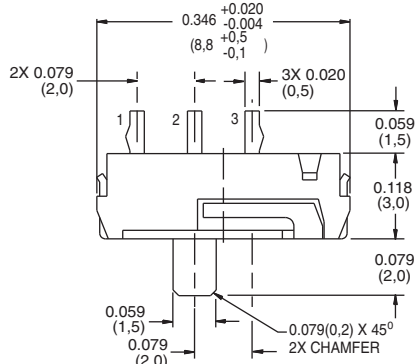

**JSM08011SAQNL**  
SPDT Surface Mount  
Momentary only

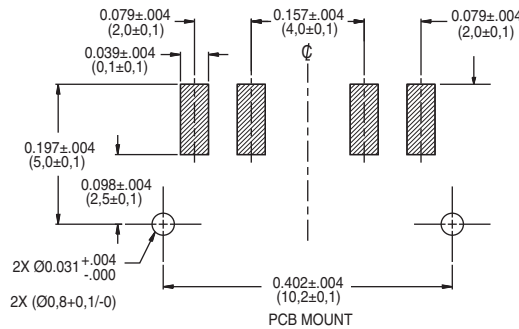
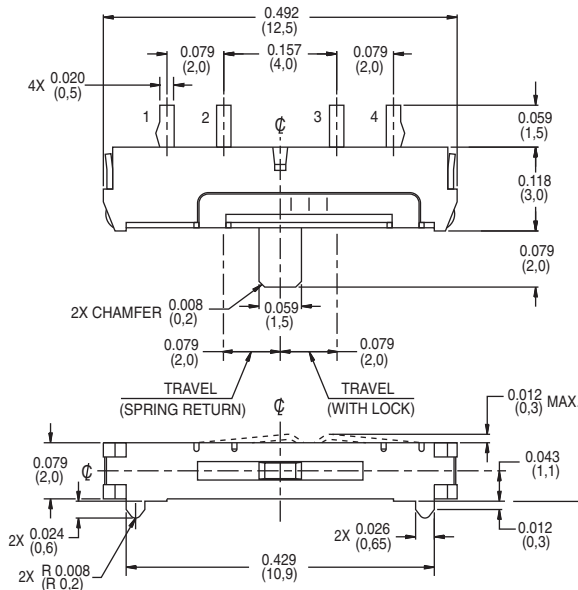
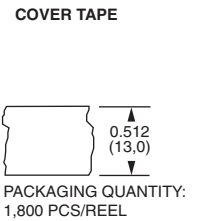
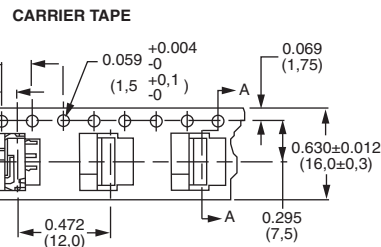
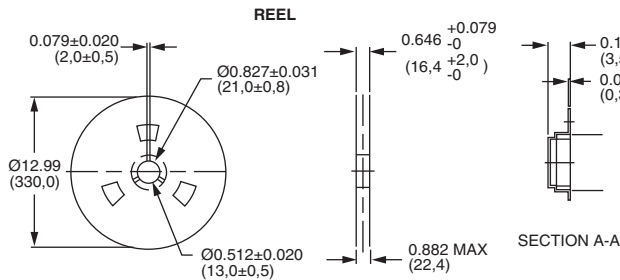
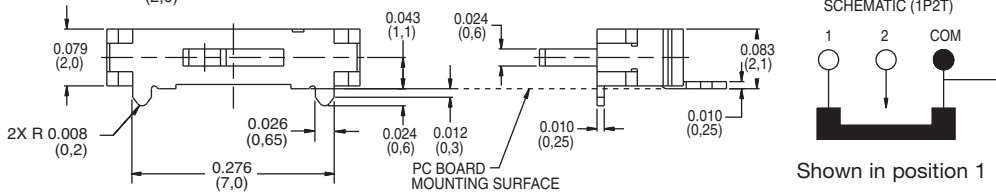

**JSM07011SAQNR**  
SP3T Surface Mount  
Momentary one side  
& Maintained the other

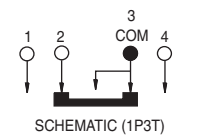

Shown in position 2



# JSM Series Sub-Miniature Slide Switches



Slide

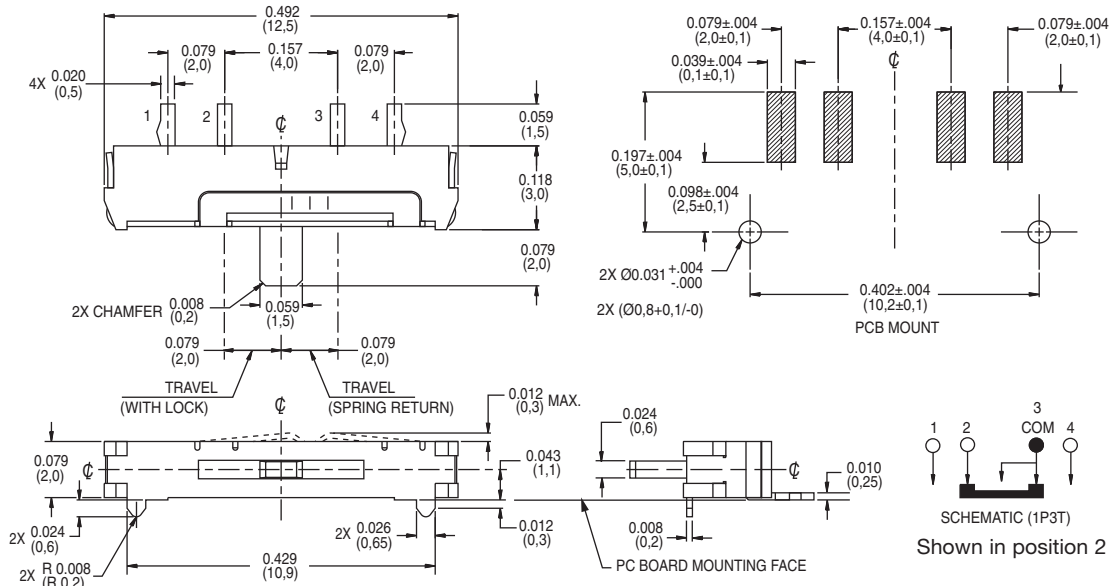

JSM07011SAQNL  
SP3T Surface Mount  
Momentary one side  
& Maintained the other

Packaging for JSM07011SAQNR and JSM07011SAQNL

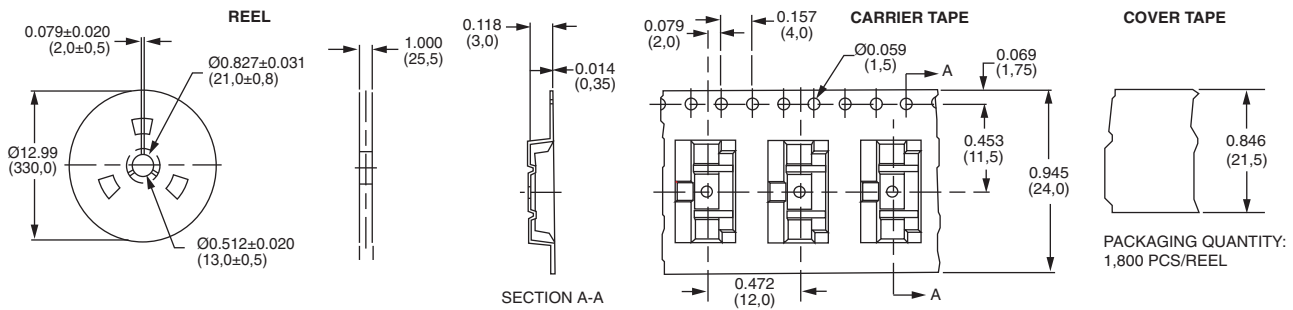

# JSM Series Sub-Miniature Slide Switches



**JSM05000SAQN**  
SP3T Surface Mount  
Momentary both sides

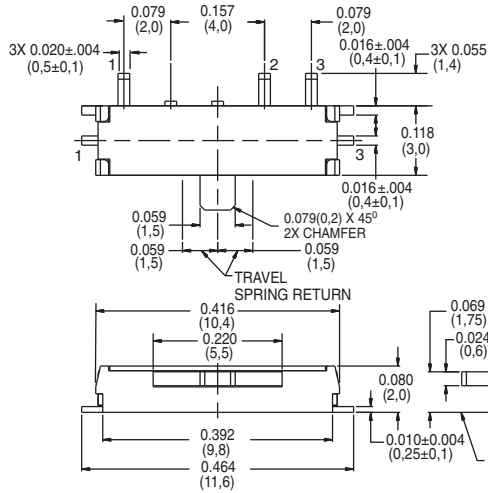

**SCHEMATIC (1P3T)**

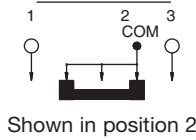

**RECOMMENDED PC BOARD LAY OUT**  
SCALE 5:1

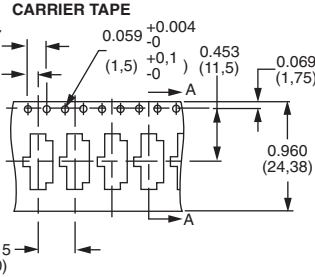
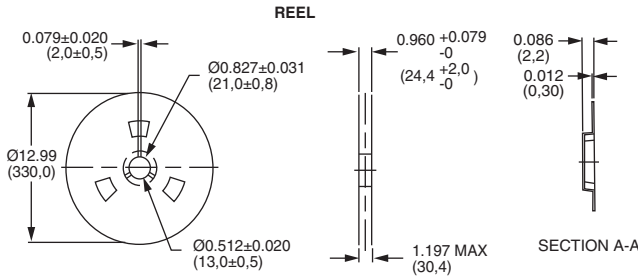
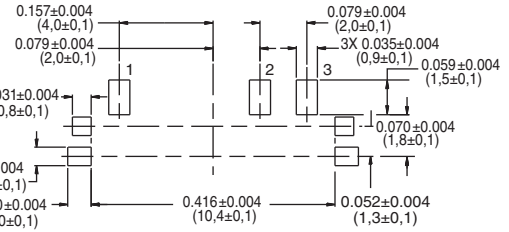

**COVER TAPE**



PACKAGING QUANTITY:  
3,400 PCS/REEL

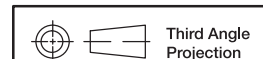

Dimensions are shown: Inches (mm)  
Specifications and dimensions subject to change

