

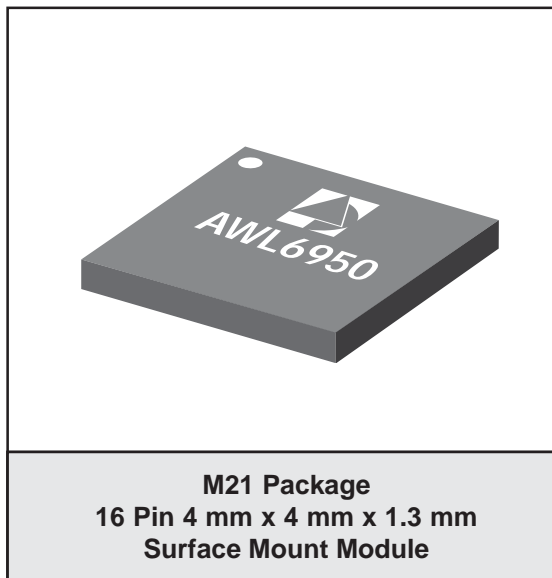

AWL6950
 2.4/5 GHz 802.11a/b/g
 WLAN Power Amplifier
 Data Sheet - Rev 2.2

FEATURES

- 3.6 % EVM @ P_{OUT} = +19 dBm with IEEE 802.11a 64 QAM OFDM at 54 Mbps
- 2.7 % EVM @ P_{OUT} = +20 dBm with IEEE 802.11g 64 QAM OFDM at 54 Mbps
- -35 dBc ACPR 1st Sidelobe, +22 dBm, with 802.11b CCK/DSSS Root Cosine Filtering, 1 Mbps
- -55 dBc ACPR 2nd Sidelobe, +22 dBm, with 802.11b CCK/DSSS Root Cosine Filtering, 1 Mbps
- 32 dB of Linear Power Gain at 2.4 GHz
- 32 dB of Linear Power Gain at 5 GHz
- Single +3.3 V Supply
- Dual Temperature-Compensated Linear Power Detectors
- 50 Ω - Matched RF Ports
- Lead-free and RoHS Compliant
- 1 kV ESD Rating (HBM)
- 4 mm x 4 mm x 1.3 mm Surface Mount Module



APPLICATIONS

- 802.11a/b/g/n WLAN

PRODUCT DESCRIPTION

The ANADIGICS AWL6950 dual band power amplifier is a high performance InGaP HBT power amplifier module designed for transmit applications in the 2.4-2.5 GHz and 4.9-5.9 GHz bands. Matched to 50 Ω at all RF inputs and outputs, the part requires no additional RF matching components off-chip, making the AWL6950 the world's simplest dual band PA module implementation available. The PA exhibits unparalleled linearity and efficiency for IEEE 802.11g, 802.11b, and 802.11a WLAN systems under the toughest signal configurations within these standards.

The power detectors are temperature compensated on chip, enabling separate single-ended output voltages for each band with excellent accuracy over a wide range of operating temperatures. The PA is biased by a single +3.3 V supply and consumes ultra-low current in the OFF mode.

The AWL6950 is manufactured using advanced InGaP HBT technology that offers state-of-the-art reliability, temperature stability, and ruggedness.

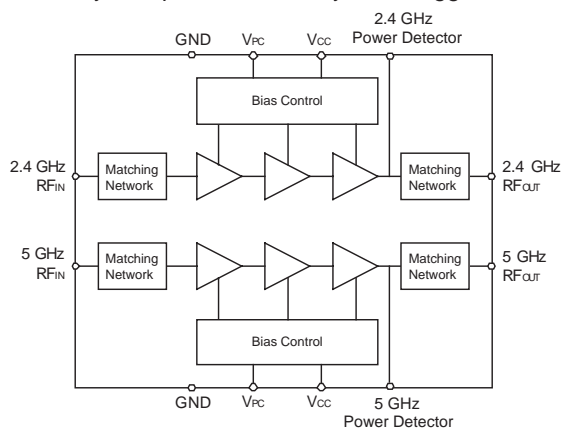

Figure 1: Block Diagram and Pinout

AWL6950

Table 1: Pin Description

PIN	NAME	DESCRIPTION
1	GND	Ground
2	RF _{IN} 2G	2 GHz RF Input. ESD protection circuits on this pin provide a DC path to ground. Avoid applying DC voltage to this pin. RF is internally matched to 50 Ω and AC coupled to the input stage. Route RF traces as coplanar waveguide using adjacent ground pins.
3	RF _{IN} 5G	5 GHz RF Input. Input stage internally matched to 50 Ω. Route as coplanar waveguide using adjacent ground pins. A shunt inductive matching element included inside the PA provides a DC path to ground at this pin. Avoid applying DC voltage to this pin.
4	GND	Ground
5	PA _{ON} 5G	5 GHz On/Off Control. The recommended use is for on/off control of the PA. Nominally, 0 V applied will turn amplifier completely off; +3.3 V should be used to set amplifier to maximum output capability.
6	GND	Ground
7	V _{CC} 5G	5 GHz Supply Voltage. Bias for power transistors of the 5 GHz PA.
8	DET _{OUT} 5G	5 GHz Power Detector Output. DC coupled power detector output. An emitter follower BJT supplies the output for this pin.
9	GND	Ground
10	RF _{OUT} 5G	5 GHz RF Output. Output stage internally matched to 50 Ω. Route as coplanar waveguide using adjacent ground pins. A shunt inductive matching element included inside the PA provides a DC path to ground at this pin. Avoid applying DC voltage to this pin.
11	RF _{OUT} 2G	2 GHz RF Output. ESD protection circuits on this pin provide a DC path to ground. Avoid applying DC voltage to this pin. RF is internally matched to 50 Ω and AC coupled to the input stage. Route RF traces as coplanar waveguide using adjacent ground pins.
12	GND	Ground
13	DET _{OUT} 2G	2 GHz Power Detector Output. DC coupled power detector output. An emitter follower BJT supplies the output for this pin.
14	V _{CC} 2G	2 GHz Power Supply. Bias for power transistors of the 2 GHz PA.
15	GND	Ground
16	PA _{ON} 2G	2 GHz On/Off Control. The recommended use is for on/off control of the PA. Nominally, 0 V applied will turn amplifier completely off; +3.3 V should be used to set amplifier to maximum output capability.

ELECTRICAL CHARACTERISTICS

Table 2: Absolute Minimum and Maximum Ratings

PARAMETER	MIN	MAX	UNIT	COMMENTS
DC Power Supply (V_{CC} 2G, V_{CC} 5G)	-	+4.5	V	
Power Control Voltage (PA_{ON} 2G, PA_{ON} 5G)	-	+4.5	V	No RF signal applied
DC Current Consumption	-	700	mA	Either PA powered separately
RF Input Level (RF_{IN} 2G, RF_{IN} 5G)	-	-5	dBm	
Operating Ambient Temperature	-40	+85	°C	
Storage Temperature	-55	+150	°C	
ESD Tolerance	1000	-	V	All pins, forward and reverse voltage. Human Body Model (HBM)

Stresses in excess of the absolute ratings may cause permanent damage. Functional operation is not implied under these conditions. Exposure to absolute ratings for extended periods of time may adversely affect reliability.

Table 3: Operating Ranges

PARAMETER	MIN	TYP	MAX	UNIT	COMMENTS
Operating Frequency (f)	2400 4900	- -	2500 5900	MHz	802.11b/g 802.11a
DC Power Supply Voltage (V_{CC} 2G, V_{CC} 5G)	+3.0	+3.3	+3.6	V	with RF applied
Power Control Voltage (PA_{ON} 2G, PA_{ON} 5G)	+2.0 0	+3.3 -	+3.6 +0.8	V	PA "ON" PA "SHUTDOWN"
Case Temperature (T_c)	-40	-	+85	°C	

The device may be operated safely over these conditions; however, parametric performance is guaranteed only over the conditions defined in the electrical specifications.

AWL6950

Table 4: Electrical Specifications - 2.4 GHz Continuous Wave
 (T_C = +25 °C, V_{CC} 2G = +3.3 V, PA_{ON} 2G = +3.3 V)

PARAMETER	MIN	TYP	MAX	UNIT	COMMENTS
P1dB	24.5	26	-	dBm	
Shutdown Current	-	30	75	μA	PA _{ON} 2G = 0 V
Quiescent Current	-	75	95	mA	PA _{ON} 2G ≥ +2.0 V, V _{CC} = +3.3 V, RF = off
Input Return Loss	-	-13	-8	dB	
Output Return Loss	-	-9	-4	dB	
Out of Band Rejection					
1 GHz	20	-	-		
1.75 GHz	0	-	-	dB	
3.2 GHz	5	-	-		
4.7 GHz	38	-	-		
Reverse Isolation	40	-	-	dB	
Stability (Spurious)	-	-	-60	dBc	6:1 VSWR, P _{OUT} = +23 dBm, -5 °C
T _{ON} Setting Time	-	-	1	μS	Settles within ±0.5 dB
T _{OFF} Setting Time	-	-	1	μS	
PA _{ON} 2G Pin Input Impedance	-	6.2	-	kΩ	Measured with +3.3 V applied to PA _{ON} 2G pin

Table 5: Electrical Specifications - 5 GHz Continuous Wave
(T_C = +25 °C, V_{CC} 5G = +3.3 V, PA_{ON} 5G = +3.3 V)

PARAMETER	MIN	TYP	MAX	UNIT	COMMENTS
P1dB	23	24.5	-	dBm	
Shutdown Current	-	32	83	μA	PA _{ON} 5G = 0 V
Quiescent Current	82	120	160	mA	PA _{ON} 5G ≥ +2.0 V, V _{CC} = +3.3 V, RF = off
Input Return Loss	-	-20	-10	dB	
Output Return Loss	-	-18	-10	dB	
Out of Band Rejection					
1.5 GHz	35	-	-		
3.5 GHz	12.5	-	-		
4 GHz	5	-	-	dB	
6.5 GHz	5	-	-		
9 GHz	30	-	-		
Reverse Isolation	40	-	-	dB	
Stability (Spurious)	-	-	-60	dBc	6:1 VSWR, P _{OUT} = +22 dBm; -5 °C
T _{ON} Setting Time	-	-	1	μS	Settles within ±0.5 dB
T _{OFF} Setting Time	-	-	1	μS	
PA _{ON} 5G Pin Input Impedance	-	6.2	-	kΩ	Measured with +3.3 V applied to PA _{ON} 5G pin

AWL6950

Table 6: Electrical Specifications - IEEE 802.11g
 (T_c = +25 °C, V_{CC 2G} = +3.3 V, P_{AON 2G} = +3.3 V, 64 QAM OFDM 54 Mbps)

PARAMETER	MIN	TYP	MAX	UNIT	COMMENTS
Operating Frequency	2400	-	2500	MHz	
Power Gain	29	32	35	dB	
Gain Ripple	-	± 0.2	± 0.5	dB	Across any 100 MHz band
Error Vector Magnitude (EVM)	-	2.7 -31.4	4.5 -27	% dB	802.11g 54 Mbps data rate P _{OUT 2G} = +20 dBm ⁽¹⁾
Current Consumption	-	185	215	mA	P _{OUT 2G} = +20 dBm
Harmonics 2fo 3fo	- - -	-53 -54	-39 -48	dBc	P _{OUT 2G} = +23 dBm ⁽²⁾
Power Detector Voltage	875	1025	1155	mV	P _{OUT 2G} = +20 dBm
Power Detector Voltage Range	100	-	1155	mV	-5 < P _{OUT 2G} < +20 dBm
Power Detector dB Range	25	-	-	dB	-5 < P _{OUT 2G} < +20 dBm
Minimum Detector Power	-	-	-5	dBm	
Maximum Detector Power	20	-	-	dBm	
Detector Resolution	10	-	-	mV/dB	
Detector Variance Over Frequency	-	0.5	2.9	dB	2.40 - 2.50 GHz
Power Detector Output Load Impedance	2	-	-	kΩ	

Notes:

(1) EVM includes system noise floor of 1% (-40 dB).

(2) Spectrum analyzer settings: RBW = 1 MHz; Span = 100 MHz.

Table 7: Electrical Specifications - IEEE 802.11b
(T_c = +25 °C, V_{CC} 2G = +3.3 V, PA_{ON} 2G = +3.3 V, CCK/DSSS, 1 Mbps, Gaussian Baseband Filtering)

PARAMETER	MIN	TYP	MAX	UNIT	COMMENTS
Operating Frequency	2400	-	2500	MHz	
Power Gain	29	32	35	dB	
Gain Ripple	-	± 0.2	± 0.5	dB	Across any 100 MHz band
Adjacent Channel Power (ACPR) 1st Sidelobe (± 11 MHz Offset)	-	-35	-33	dBc	1 Mbps Gaussian Baseband Filtering; P _{OUT} 2G = +20 dBm
Adjacent Channel Power (ACPR) 2nd Sidelobe (± 22 MHz Offset)	-	-55	-53	dBc	1 Mbps Gaussian Baseband Filtering; P _{OUT} 2G = +20 dBm
Current Consumption	-	190	225	mA	P _{OUT} 2G = +20 dBm
Harmonics 2fo 3fo	- - -	-60 -53	-50 -43	dBc	P _{OUT} 2G = +23 dBm ⁽¹⁾
Power Detector Voltage	925	1075	1250	mV	P _{OUT} 2G = +20 dBm
Power Detector Voltage Range	100	-	1250	mV	-5 < P _{OUT} 2G < +20 dBm
Power Detector dB Range	25	-	-	mV	-5 < P _{OUT} 2G < +20 dBm
Minimum Detector Power	-	-	-5	dBm	
Maximum Detector Power	20	-	-	dBm	
Detector Resolution	10	-	-	mV/dB	
Detector Variance Over Frequency	-	0.5	2.6	dB	
Power Detector Output Load Impedance	2	-	-	kΩ	

Note:

(1) Spectrum analyzer settings: RBW = 1 MHz; Span = 100 MHz.

AWL6950

Table 8: Electrical Specifications - IEEE 802.11a
 (T_C = +25 °C, V_{CC 5G} = +3.3 V, P_{AON 5G} = +3.3 V, 64 QAM OFDM 54 Mbps)

PARAMETER	MIN	TYP	MAX	UNIT	COMMENTS
Operating Frequency	4900	-	5900	MHz	
Power Gain	27 30 30 28	30 33.5 33.5 31	34 38 36.5 35.5	dB	4.9 GHz 5.25 GHz 5.55 GHz 5.85 GHz
Gain Ripple	-	±0.5	±2.0	dB	Across any 100 MHz band
Error Vector Magnitude (EVM)	- -	3.6 -29	4.5 -27	% dB	P _{OUT 5G} = +19 dBm, 4.9 - 5.85 GHz 802.11a 54 Mbps data rate ⁽¹⁾
Current Consumption	-	215	250	mA	P _{OUT 5G} = +19 dBm
Harmonics 2fo 3fo	- -	-40 -50	-34 -43	dBc	P _{OUT 5G} = +20 dBm ⁽²⁾
Power Detector Voltage	910	1070	1225	mV	P _{OUT 5G} = +19 dBm
Power Detector Voltage Range	100	-	1225	mV	-5 < P _{OUT 5G} < +20 dBm
Power Detector dB Range	25	-	-	dB	-5 < P _{OUT 5G} < +20 dBm
Minimum Power Detector	-	-	-5	dBm	
Maximum Power Detector	20	-	-	dBm	
Detector Resolution	10	-	-	mV/dB	
Detector Variance Over Frequency	-	1.1	4.7	dB	4.90 - 5.85 GHz
Power Detector Output Load Impedance	2	-	-	kΩ	

Notes:

- (1) EVM includes system noise floor of 1% (-40dB).
- (2) Spectrum analyzer settings: RBW = 1 MHz; Span = 100 MHz.

802.11g PERFORMANCE DATA

Figure 2: Gain and I_{cc} vs. Output Power Across Frequency (V_{CC} = +3.3 V, T_C = +25°C) 802.11g 54 Mbps OFDM

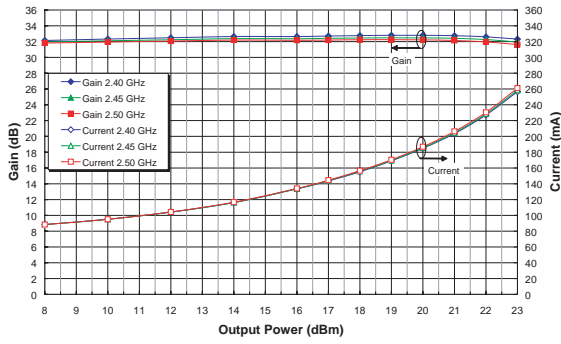

Figure 3: Gain and I_{cc} vs. Output Power Across Temp (Frequency = 2.45 GHz, V_{CC} = +3.3 V) 802.11g 54 Mbps OFDM

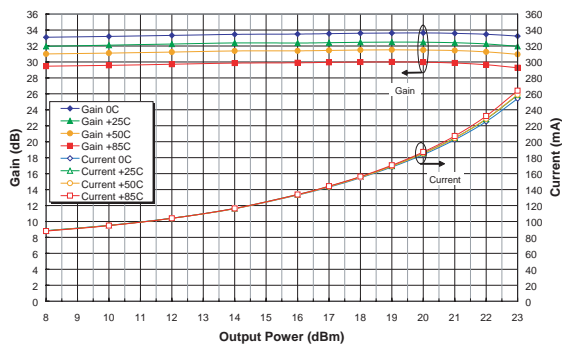

Figure 4: Gain and I_{cc} vs. Output Power Across Power Supply Voltage (Freq = 2.45 GHz, T_C = 25°C) 802.11g 54 Mbps OFDM

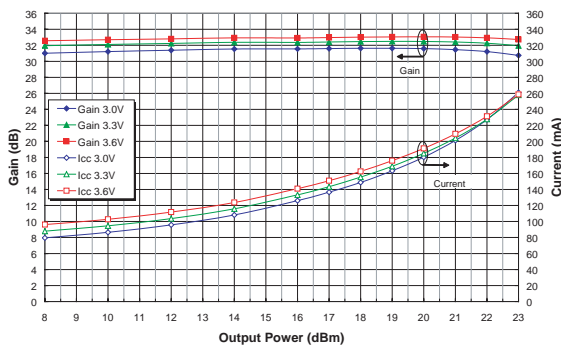

Figure 5: EVM vs. Output Power Across Frequency (V_{CC} = +3.3 V, T_C = 25°C) 802.11g 54 Mbps OFDM

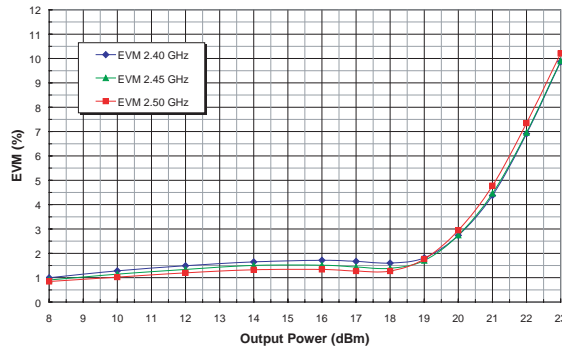

Figure 6: EVM vs. Output Power Across Temp (Frequency = 2.45 GHz, V_{CC} = +3.3 V) 802.11g 54 Mbps OFDM

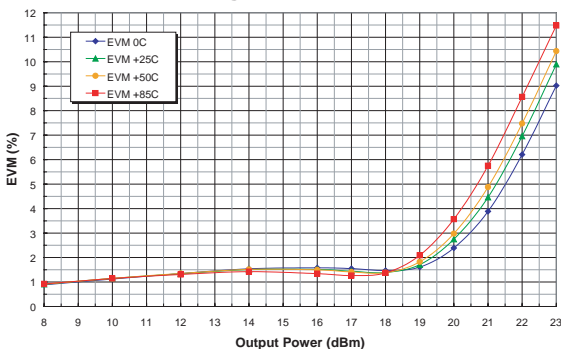
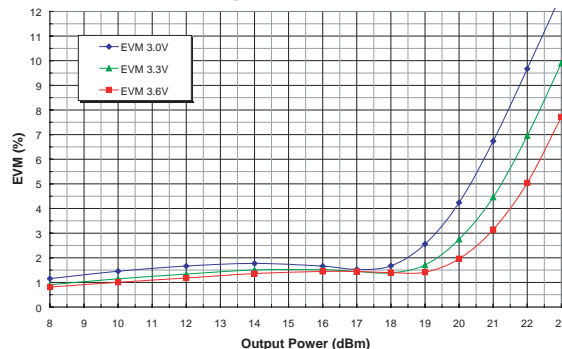

Figure 7: EVM vs. Output Power Across Power Supply Voltage (Freq = 2.45 GHz, T_C = 25°C) 802.11g 54 Mbps OFDM



AWL6950

802.11g PERFORMANCE DATA

**Figure 8: Detector Voltage vs. Output Power Across Frequency ($T_c = 25^\circ\text{C}$, $V_{CC} = +3.3\text{ V}$)
802.11g 54 Mbps OFDM**

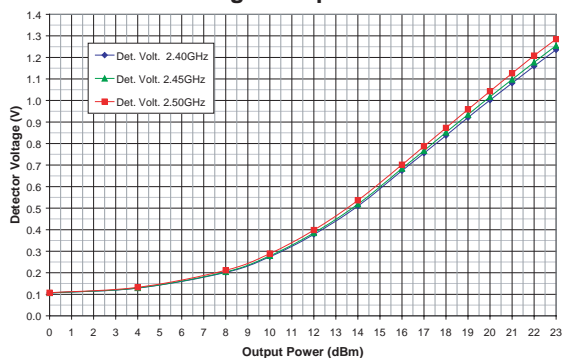

**Figure 9: Detector Voltage vs. Output Power Across Temperature (Freq = 2.45 GHz, $V_{CC} = +3.3\text{ V}$)
802.11g 54 Mbps OFDM**

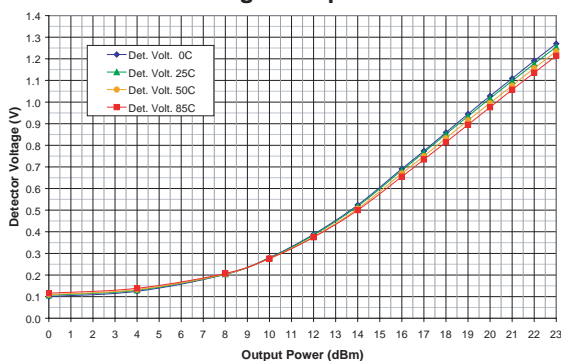

**Figure 10: Detector Voltage vs. Output Power Across Power Supply Voltage (Freq = 2.45 GHz, $T_c = 25^\circ\text{C}$)
802.11g 54 Mbps OFDM**

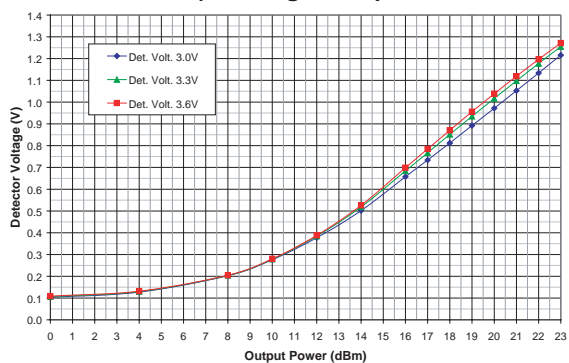

802.11b PERFORMANCE DATA

Figure 11: Gain and I_{CC} vs. Output Power Across Frequency (V_{CC} = +3.3 V, T_C = +25°C) 802.11b Gaussian Filtering (BT = 0.5), 1 Mbps

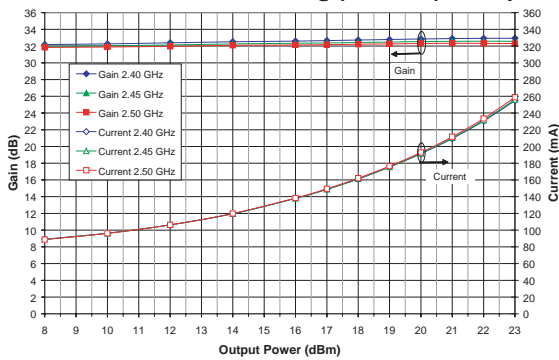

Figure 12: Gain and I_{CC} vs. Output Power Across Temp (Freq = 2.45 GHz, V_{CC} = +3.3 V) 802.11b Gaussian Filtering (BT = 0.5), 1 Mbps

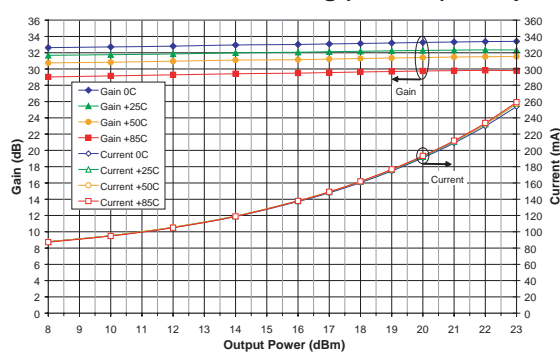

Figure 13: Gain and I_{CC} vs. Output Power Across Power Supply Voltage (Freq = 2.45 GHz, T_C = 25°C) 802.11b Gaussian Filtering (BT = 0.5), 1 Mbps

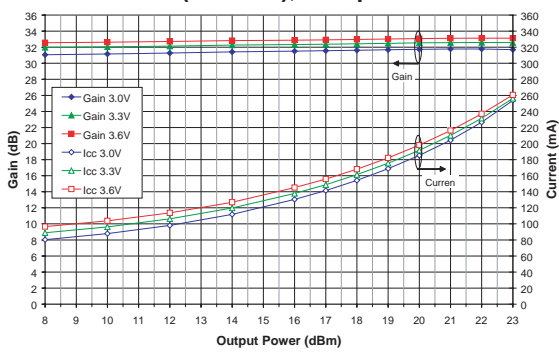

Figure 14: ACPR vs. Output Power Across Frequency (V_{CC} = +3.3 V, T_C = 25°C) 802.11b Gaussian Filtering (BT = 0.5), 1 Mbps

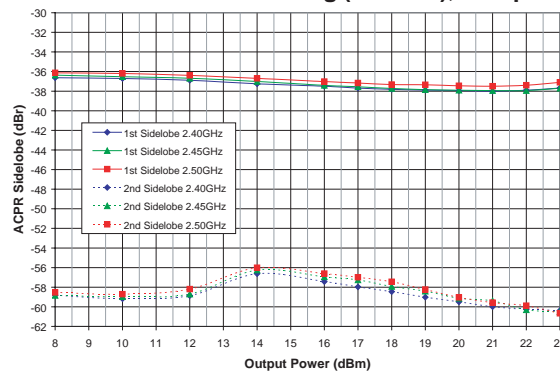

Figure 15: ACPR vs. Output Power Across Temp (Freq = 2.45 GHz, V_{CC} = +3.3 V) 802.11b Gaussian Filtering (BT = 0.5), 1 Mbps

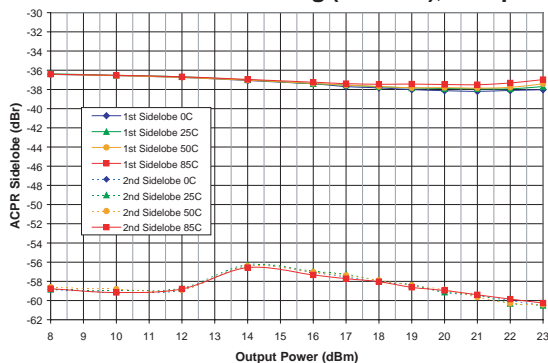

Figure 16: ACPR vs. Output Power Across Power Supply Voltage (Freq = 2.45 GHz, T_C = 25°C) 802.11b Gaussian Filtering (BT = 0.5), 1 Mbps

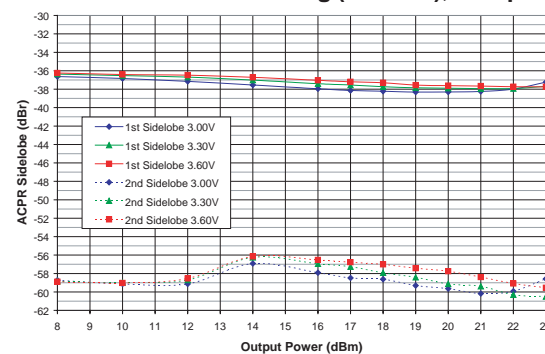

Figure 17: Detector Voltage vs. Output Power Across Frequency ($T_c = 25^\circ\text{C}$, $V_{CC} = +3.3\text{ V}$) 802.11b Gaussian Filtering (BT = 0.5), 1 Mbps

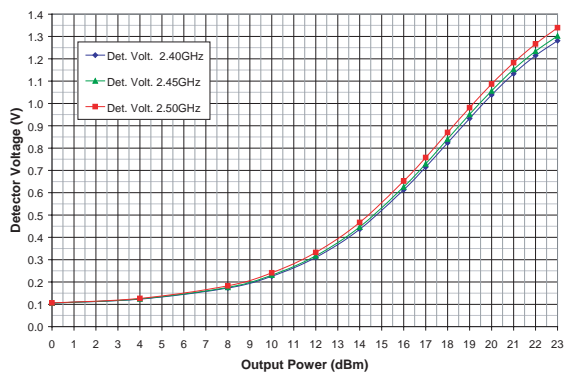

Figure 18: Detector Voltage vs. Output Power Across Temp (Freq = 2.45 GHz, $V_{CC} = +3.3\text{ V}$) 802.11b Gaussian Filtering (BT = 0.5), 1 Mbps

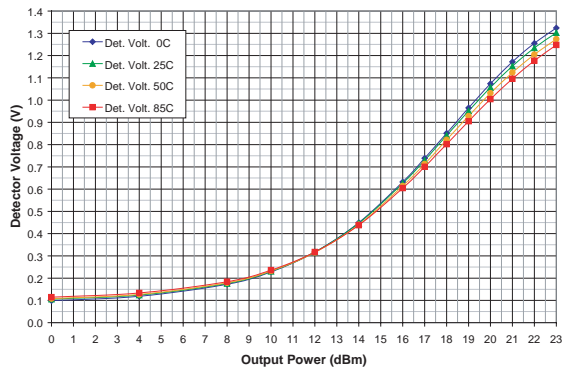
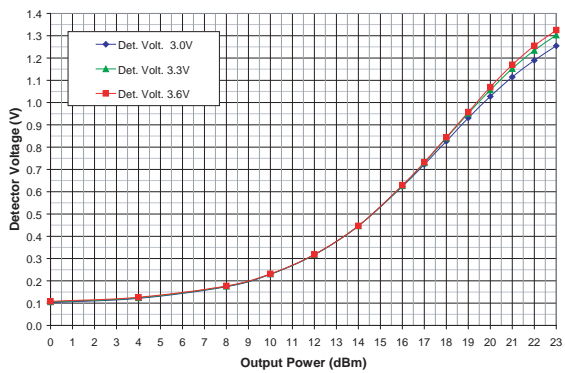

Figure 19: Detector Voltage vs. Output Power Across Power Supply Voltage (Freq = 2.45 GHz, $T_c = 25^\circ\text{C}$) 802.11b Gaussian Filtering (BT = 0.5), 1 Mbps



802.11a PERFORMANCE DATA

Figure 20: Gain and I_{cc} vs. Output Power Across Frequency (V_{CC} = +3.3 V, T_C = +25°C)
802.11a 54 Mbps OFDM

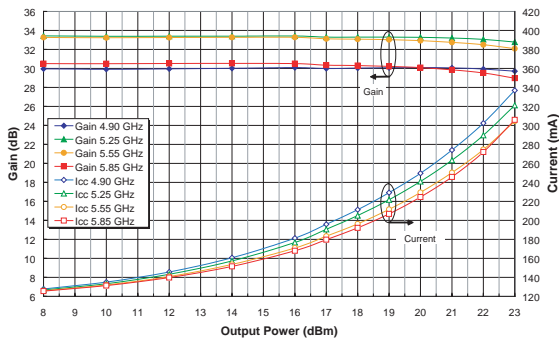

Figure 21: Gain and I_{cc} vs. Output Power Across Temp (Freq = 5.25 GHz, V_{CC} = +3.3 V)
802.11a 54 Mbps OFDM

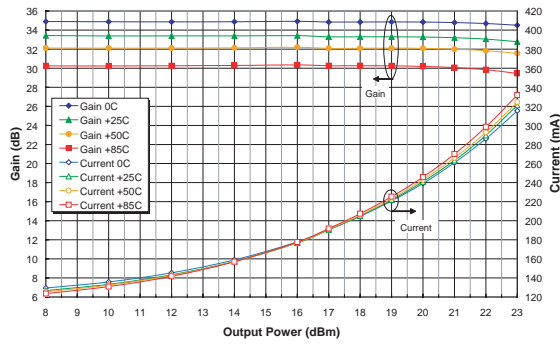

Figure 22: Gain and I_{cc} vs. Output Power Across Power Supply Voltage (Freq = 5.25 GHz, T_C = 25°C)
802.11a 54 Mbps OFDM

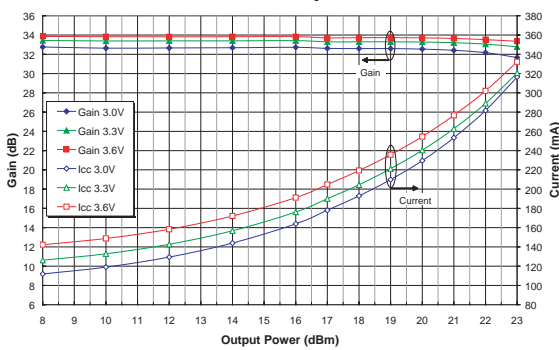

Figure 23: EVM vs. Output Power Across Frequency (V_{CC} = +3.3 V, T_C = 25°C)
802.11a 54 Mbps OFDM

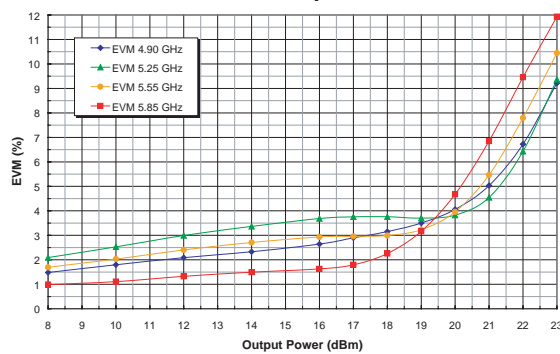

Figure 24: EVM vs. Output Power Across Temp (Freq = 5.25 GHz, V_{CC} = +3.3 V)
802.11a 54 Mbps OFDM

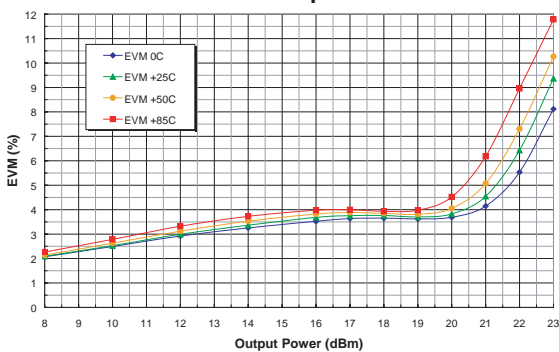

Figure 25: EVM vs. Output Power Across Power Supply Voltage (Freq = 5.25 GHz, T_C = 25°C)
802.11a 54 Mbps OFDM

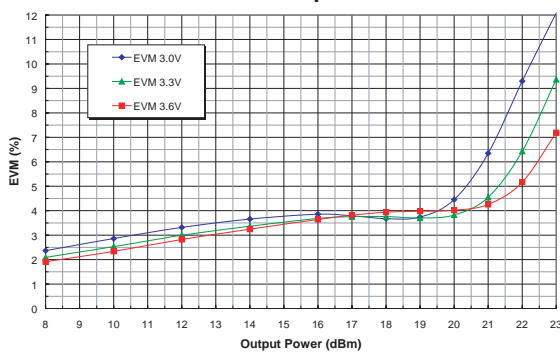

Figure 26: Detector Voltage vs. Output Power Across Frequency ($T_c = 25^\circ\text{C}$, $V_{CC} = +3.3\text{ V}$) 802.11a 54 Mbps OFDM

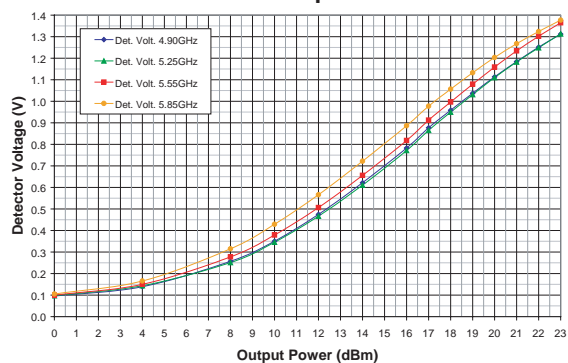

Figure 27: Detector Voltage vs. Output Power Across Temperature (Freq = 5.25 GHz, $V_{CC} = +3.3\text{ V}$) 802.11a 54 Mbps OFDM

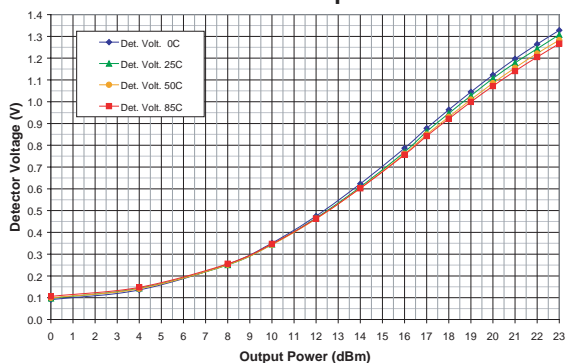
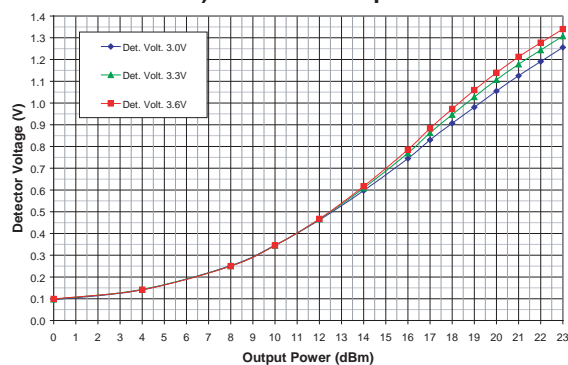

Figure 28: Detector Voltage vs. Output Power Across Power Supply Voltage (Freq = 5.25 GHz, $T_c = 25^\circ\text{C}$) 802.11a 54 Mbps OFDM



S-PARAMETER PERFORMANCE DATA

Figure 29: 2.4 GHz Return Losses Across Frequency ($V_{CC} = +3.3\text{ V}$, $T_c = 25^\circ\text{C}$)

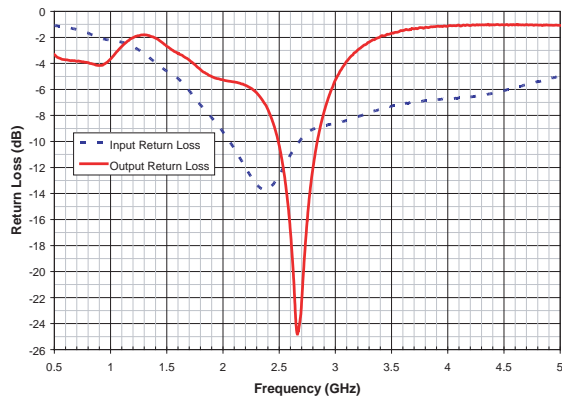

Figure 30: 2.4 GHz S21 Response Across Frequency ($V_{CC} = +3.3\text{ V}$, $T_c = 25^\circ\text{C}$)

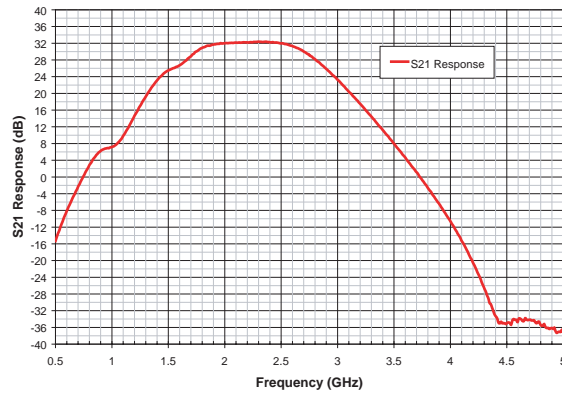

Figure 31: 5 GHz Return Losses Across Frequency ($V_{CC} = +3.3\text{ V}$, $T_c = 25^\circ\text{C}$)

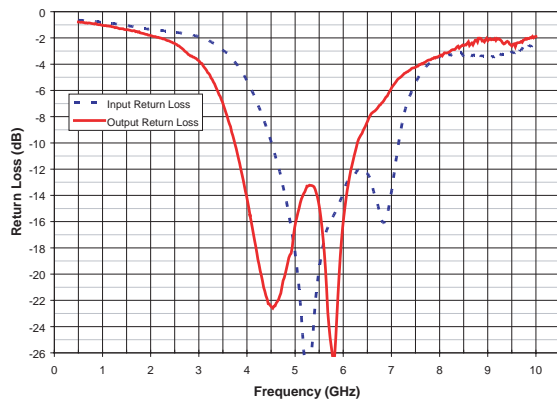
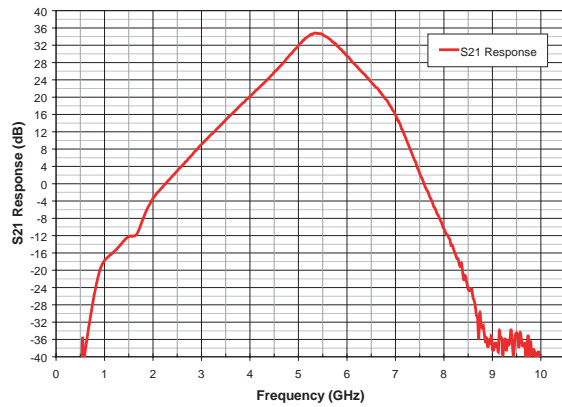

Figure 32: 5 GHz S21 Response Across Frequency ($V_{CC} = +3.3\text{ V}$, $T_c = 25^\circ\text{C}$)



AWL6950

APPLICATION INFORMATION

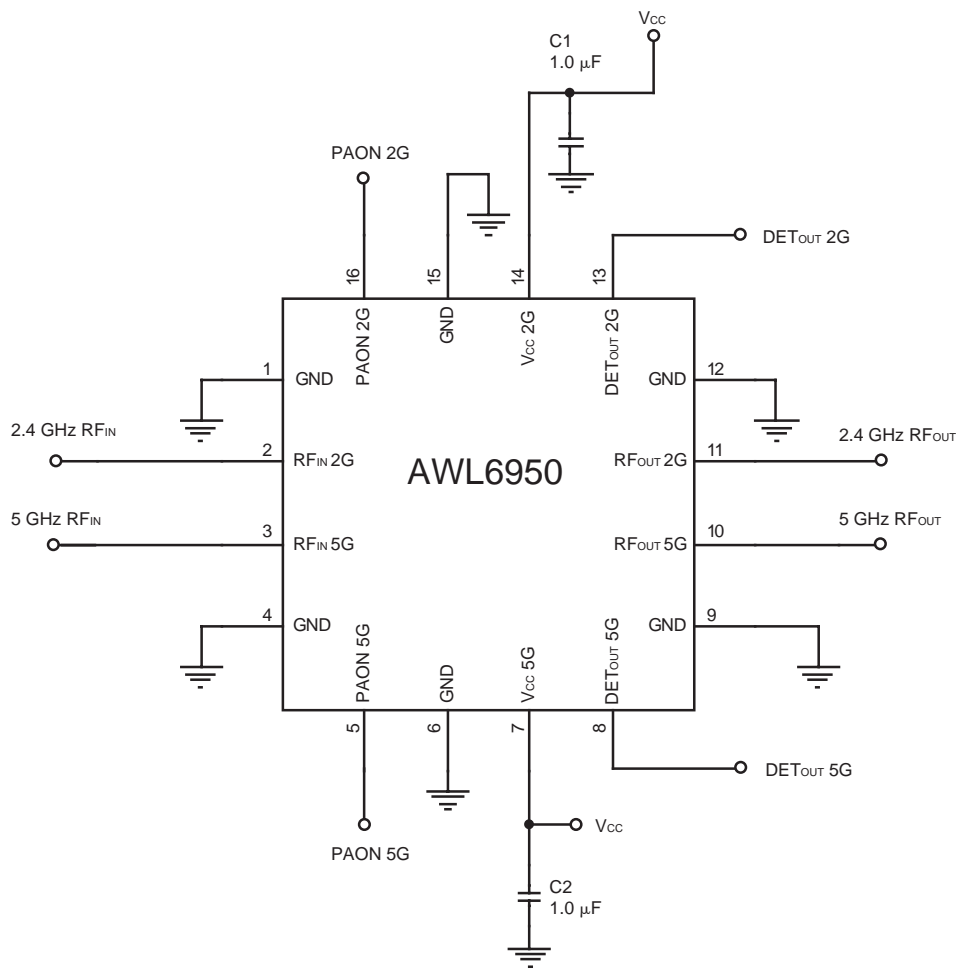
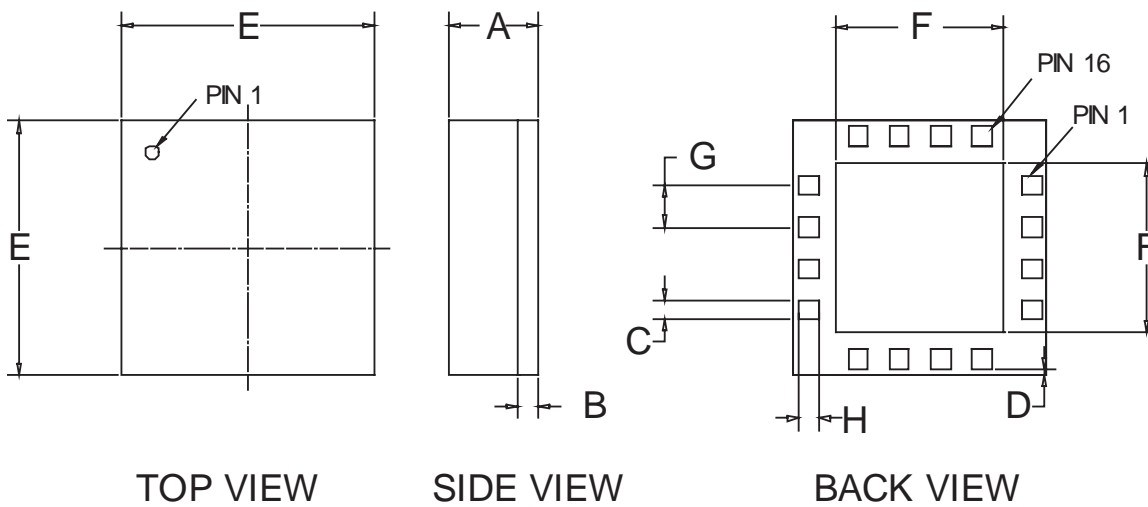

Figure 33: Application Circuit

PACKAGE OUTLINE



DIMENSION	MILLIMETERS		
	MIN	TYP	MAX
A	1.22	1.30	1.40
B	--	0.30	--
C	0.225	--	0.505
D	--	0.075	--
E	3.88	4.00	4.12
F	2.56	--	2.73
G	--	0.65	--
H	0.225	--	0.505

Figure 34: M21 Package Outline - 16 Pin 4 mm x 4 mm x 1.3 mm Surface Mount Module

Top Brand

AWL6950R

LLLLNN

H1YYWWCC

Notes

1. ANADIGICS LOGO SIZE: 1.0 MM HIGH
2. PART NUMBER (LINE 1): AWL6950R
3. WAFER LOT NUMBER: LLLL = FOUR DIGIT LOT NUMBER
(LINE 2) NN = TWO DIGIT WAFER NUMBER
4. PIN 1 INDICATOR: LASER DOT
5. ASSEMBLY INFO (LINE 3): H1 = REV H1
YY = TWO DIGIT YEAR, WW = WORK WEEK
COUNTRY CODE:
CC = TH: THAILAND, TW: TAIWAN,
PH: PHILIPPINES, CH: CHINA,
ID: INDONESIA, HK: HONG KONG,
US: UNITED STATES
6. TYPE : ARIAL
SIZE : 1.5-POINT
COLOR : LASER

Figure 35: Branding Specification

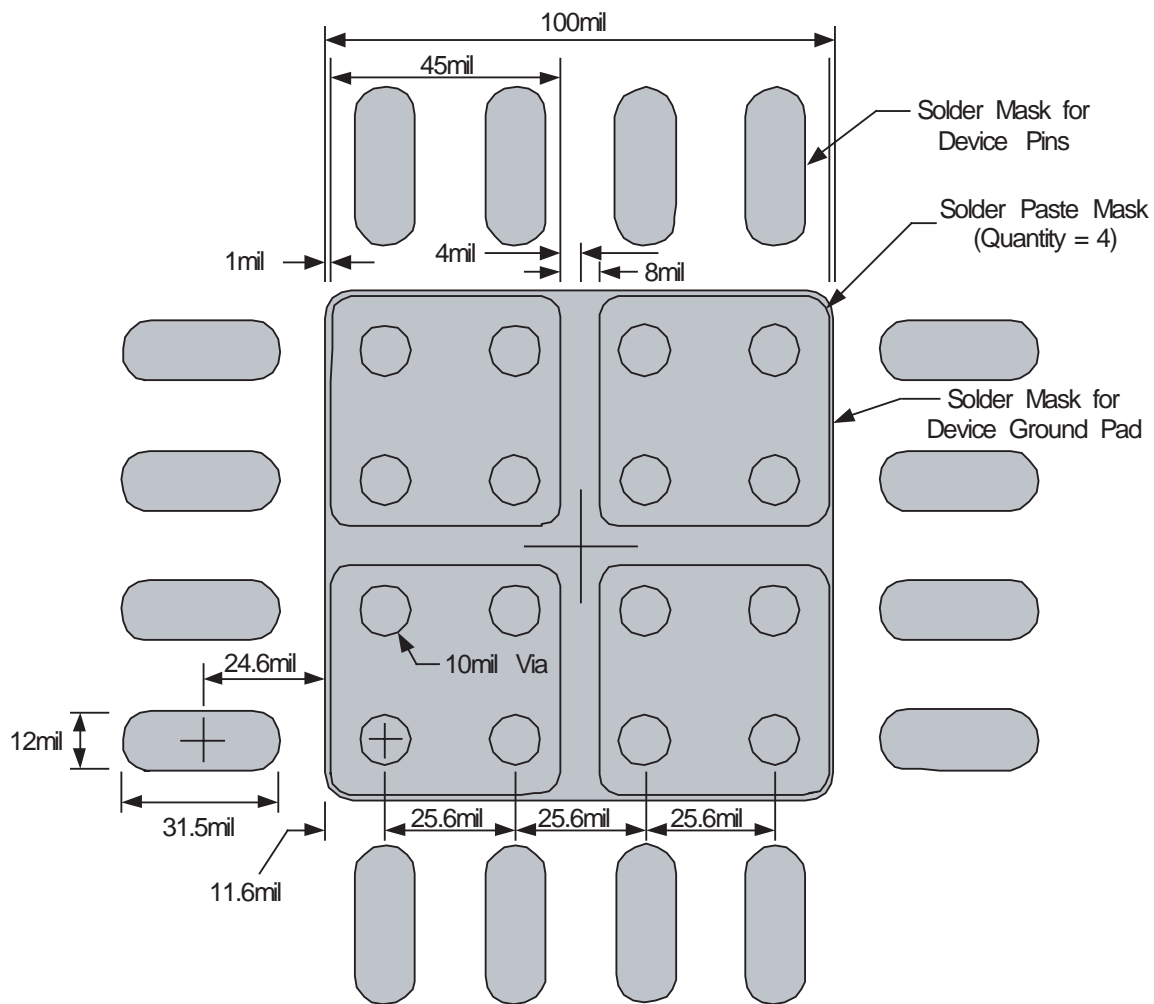

Figure 36: Recommended PCB Layout

AWL6950

NOTES

AWL6950**ORDERING INFORMATION**

ORDER NUMBER	TEMPERATURE RANGE	PACKAGE DESCRIPTION	COMPONENT PACKAGING
AWL6950RM21P8	-40 °C to +85°C	RoHS-compliant 16 Pin 4 mm x 4 mm x 1.3 mm Surface Mount Module	2,500 piece Tape and Reel
AWL6950RM21P0	-40 °C to +85°C	RoHS-compliant 16 Pin 4 mm x 4 mm x 1.3 mm Surface Mount Module	1-999 piece Tubes
AWL6950RM21P6	-40 °C to +85°C	RoHS-compliant 16 Pin 4 mm x 4 mm x 1.3 mm Surface Mount Module	1-999 piece Tray
EVA6950RM21	-40 °C to +85°C	RoHS-compliant 16 Pin 4 mm x 4 mm x 1.3 mm Surface Mount Module	1 piece Evaluation Board

**ANADIGICS, Inc.**

141 Mount Bethel Road
Warren, New Jersey 07059, U.S.A.
Tel: +1 (908) 668-5000
Fax: +1 (908) 668-5132

URL: <http://www.anadigics.com>
E-mail: Mktg@anadigics.com

IMPORTANT NOTICE

ANADIGICS, Inc. reserves the right to make changes to its products or to discontinue any product at any time without notice. The product specifications contained in Advanced Product Information sheets and Preliminary Data Sheets are subject to change prior to a product's formal introduction. Information in Data Sheets have been carefully checked and are assumed to be reliable; however, ANADIGICS assumes no responsibilities for inaccuracies. ANADIGICS strongly urges customers to verify that the information they are using is current before placing orders.

WARNING

ANADIGICS products are not intended for use in life support appliances, devices or systems. Use of an ANADIGICS product in any such application without written consent is prohibited.