

**Buck chopper  
Trench + Field Stop IGBT®  
Power Module**

**$V_{CES} = 600V$   
 $I_C = 75A @ T_c = 80^\circ C$**

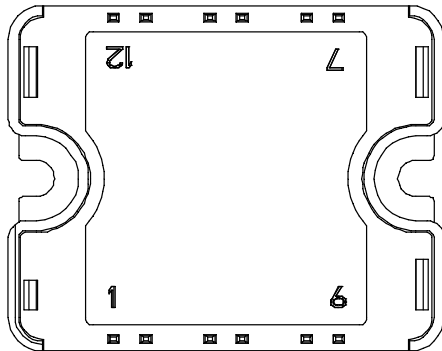
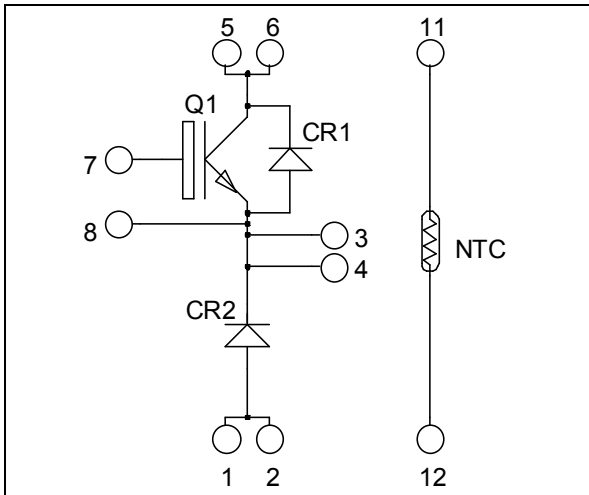

Pins 1/2 ; 3/4 ; 5/6 must be shorted together

### Application

- AC and DC motor control
- Switched Mode Power Supplies

### Features

- Trench + Field Stop IGBT® Technology
  - Low voltage drop
  - Low tail current
  - Switching frequency up to 20 kHz
  - Soft recovery parallel diodes
  - Low diode VF
  - Low leakage current
  - RBSOA and SCSOA rated
- Very low stray inductance
- Internal thermistor for temperature monitoring
- High level of integration

### Benefits

- Outstanding performance at high frequency operation
- Direct mounting to heatsink (isolated package)
- Low junction to case thermal resistance
- Solderable terminals both for power and signal for easy PCB mounting
- Low profile
- RoHS Compliant

### Absolute maximum ratings

Symbol	Parameter	Max ratings	Unit
$V_{CES}$	Collector - Emitter Breakdown Voltage	600	V
$I_C$	Continuous Collector Current	$T_c = 25^\circ C$	100
		$T_c = 80^\circ C$	75
$I_{CM}$	Pulsed Collector Current	$T_c = 25^\circ C$	140
$V_{GE}$	Gate - Emitter Voltage	$\pm 20$	V
$P_D$	Maximum Power Dissipation	$T_c = 25^\circ C$	250
RBSOA	Reverse Bias Safe Operating Area	$T_J = 150^\circ C$	150A @ 550V

**CAUTION:** These Devices are sensitive to Electrostatic Discharge. Proper Handling Procedures Should Be Followed. See application note APT0502 on [www.microsemi.com](http://www.microsemi.com)

All ratings @  $T_j = 25^\circ\text{C}$  unless otherwise specified

**Electrical Characteristics**

Symbol	Characteristic	Test Conditions	Min	Typ	Max	Unit
$I_{CES}$	Zero Gate Voltage Collector Current	$V_{GE} = 0V, V_{CE} = 600V$			250	$\mu\text{A}$
$V_{CE(sat)}$	Collector Emitter Saturation Voltage	$V_{GE} = 15V$ $I_C = 75A$		1.5 1.7	1.9	V
$V_{GE(th)}$	Gate Threshold Voltage	$V_{GE} = V_{CE}, I_C = 600\mu\text{A}$	5.0	5.8	6.5	V
$I_{GES}$	Gate – Emitter Leakage Current	$V_{GE} = 20V, V_{CE} = 0V$			600	nA

**Dynamic Characteristics**

Symbol	Characteristic	Test Conditions	Min	Typ	Max	Unit
$C_{ies}$	Input Capacitance	$V_{GE} = 0V$		4620		pF
$C_{oes}$	Output Capacitance	$V_{CE} = 25V$		300		
$C_{res}$	Reverse Transfer Capacitance	$f = 1\text{MHz}$		140		
$T_{d(on)}$	Turn-on Delay Time	Inductive Switching ( $25^\circ\text{C}$ ) $V_{GE} = \pm 15V$ $V_{Bus} = 300V$ $I_C = 75A$ $R_G = 4.7\Omega$		110		ns
$T_r$	Rise Time			45		
$T_{d(off)}$	Turn-off Delay Time			200		
$T_f$	Fall Time			40		
$T_{d(on)}$	Turn-on Delay Time	Inductive Switching ( $150^\circ\text{C}$ ) $V_{GE} = \pm 15V$ $V_{Bus} = 300V$ $I_C = 75A$ $R_G = 4.7\Omega$		120		ns
$T_r$	Rise Time			50		
$T_{d(off)}$	Turn-off Delay Time			250		
$T_f$	Fall Time			60		
$E_{on}$	Turn-on Switching Energy	$V_{GE} = \pm 15V$ $V_{Bus} = 300V$ $I_C = 75A$	$T_j = 25^\circ\text{C}$	0.35		mJ
			$T_j = 150^\circ\text{C}$	0.6		
$E_{off}$	Turn-off Switching Energy	$R_G = 4.7\Omega$	$T_j = 25^\circ\text{C}$	2.2		mJ
			$T_j = 150^\circ\text{C}$	2.6		

**Chopper diode ratings and characteristics**

Symbol	Characteristic	Test Conditions	Min	Typ	Max	Unit
$V_{RRM}$	Maximum Peak Repetitive Reverse Voltage		600			V
$I_{RM}$	Maximum Reverse Leakage Current	$V_R = 600V$			250 500	$\mu\text{A}$
$I_F$	DC Forward current			75		A
$V_F$	Diode Forward Voltage	$I_F = 75A$ $V_{GE} = 0V$	$T_j = 25^\circ\text{C}$ $T_j = 150^\circ\text{C}$	1.6 1.5	2	V
$t_{rr}$	Reverse Recovery Time	$I_F = 75A$ $V_R = 300V$ $di/dt = 2000A/\mu\text{s}$	$T_j = 25^\circ\text{C}$	100		ns
			$T_j = 150^\circ\text{C}$	150		
$Q_{rr}$	Reverse Recovery Charge		$T_j = 25^\circ\text{C}$	3.6		$\mu\text{C}$
			$T_j = 150^\circ\text{C}$	7.6		
$E_r$	Reverse Recovery Energy		$T_j = 25^\circ\text{C}$ $T_j = 150^\circ\text{C}$	0.85 1.8		mJ

## Thermal and package characteristics

Symbol	Characteristic	Min	Typ	Max	Unit	
R <sub>thJC</sub>	Junction to Case Thermal Resistance	IGBT		0.60	°C/W	
		Diode		0.98		
V <sub>ISOL</sub>	RMS Isolation Voltage, any terminal to case t=1 min, I isol<1mA, 50/60Hz	2500			V	
T <sub>J</sub>	Operating junction temperature range	-40		175	°C	
T <sub>STG</sub>	Storage Temperature Range	-40		125		
T <sub>C</sub>	Operating Case Temperature	-40		100		
Torque	Mounting torque	To heatsink	M4	2.5	4.7	N.m
Wt	Package Weight				80	g

## Temperature sensor NTC (see application note APT0406 on www.microsemi.com for more information).

Symbol	Characteristic	Min	Typ	Max	Unit
R <sub>25</sub>	Resistance @ 25°C		50		kΩ
B <sub>25/85</sub>	T <sub>25</sub> = 298.15 K		3952		K

$$R_T = \frac{R_{25}}{\exp \left[ B_{25/85} \left( \frac{1}{T_{25}} - \frac{1}{T} \right) \right]}$$

T: Thermistor temperature  
 R<sub>T</sub>: Thermistor value at T

## SP1 Package outline (dimensions in mm)



See application note 1904 - Mounting Instructions for SP1 Power Modules on [www.microsemi.com](http://www.microsemi.com)

## Typical Performance Curve

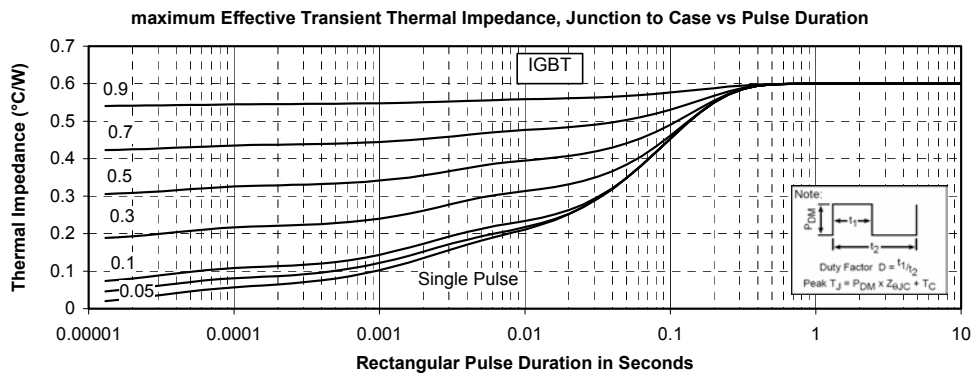
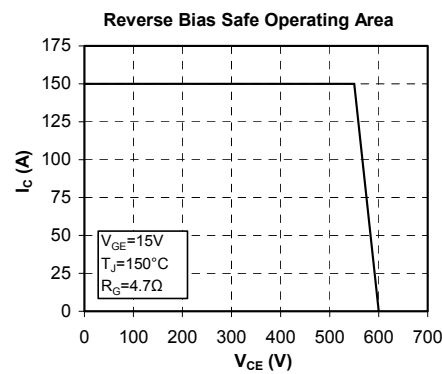
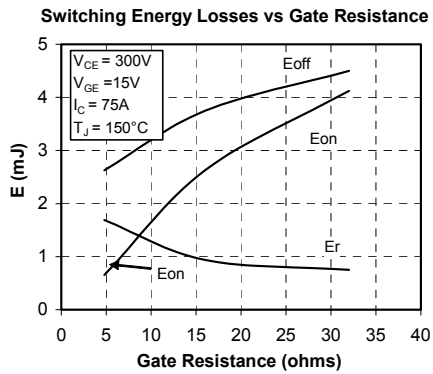
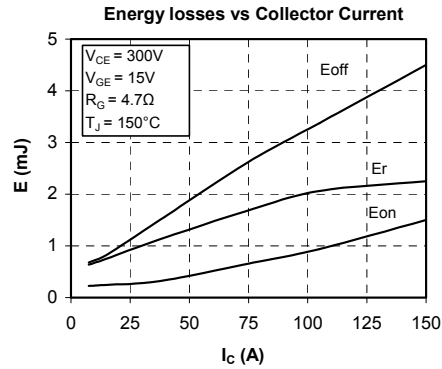
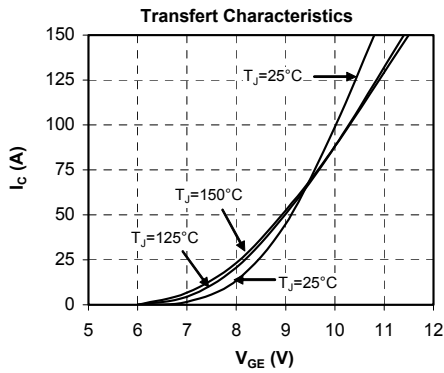
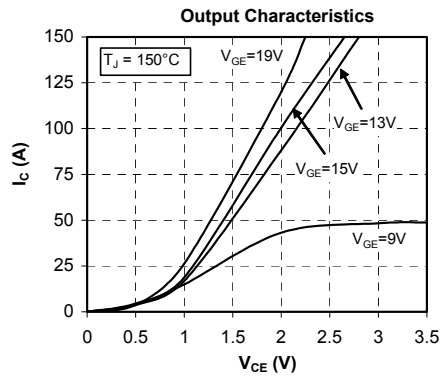
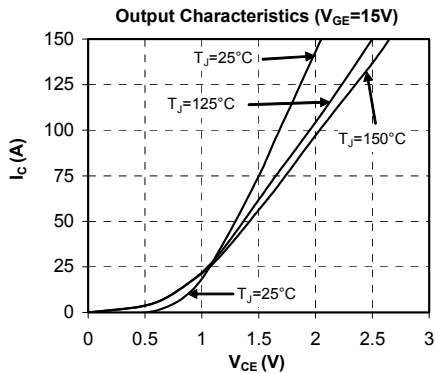

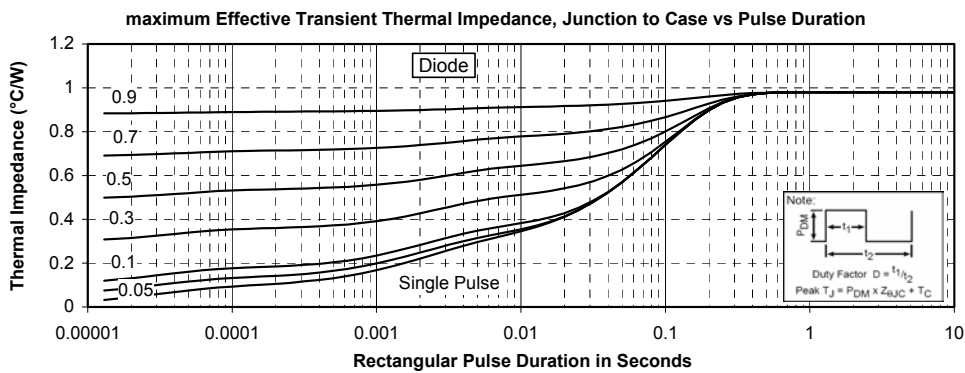
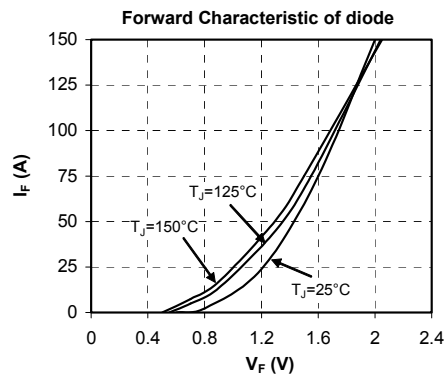
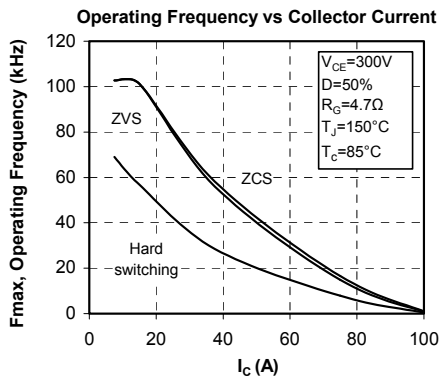

Microsemi reserves the right to change, without notice, the specifications and information contained herein

Microsemi's products are covered by one or more of U.S. patents 4,895,810 5,045,903 5,089,434 5,182,234 5,019,522 5,262,336 6,503,786 5,256,583 4,748,103 5,283,202 5,231,474 5,434,095 5,528,058 and foreign patents. U.S. and Foreign patents pending. All Rights Reserved.