

AKD4550

Evaluation board Rev.C for AK4550

GENERAL DESCRIPTION

AKD4550 is an evaluation board for the portable digital audio 16bit A/D and D/A converter, AK4550. The AKD4550 can evaluate A/D converter and D/A converter separately in addition to loopback mode (A/D → D/A). The A/D section can be evaluated by interfacing with AKM's DAC evaluation boards directly. The AKD4550 has the interface with AKM's wave generator using ROM data and AKM's ADC evaluation boards. Therefore, it's easy to evaluate the D/A section. The AKD4550 also has the digital audio interface and can achieve the interface with digital audio systems via opt-connector.

■ **Ordering guide**

AKD4550 --- Evaluation board for AK4550

FUNCTION

- **Compatible with 2 types of interface**
 - Direct interface with AKM's A/D & D/A converter evaluation boards
 - DIT/DIR with optical input/output
- **BNC connector for an external clock input**

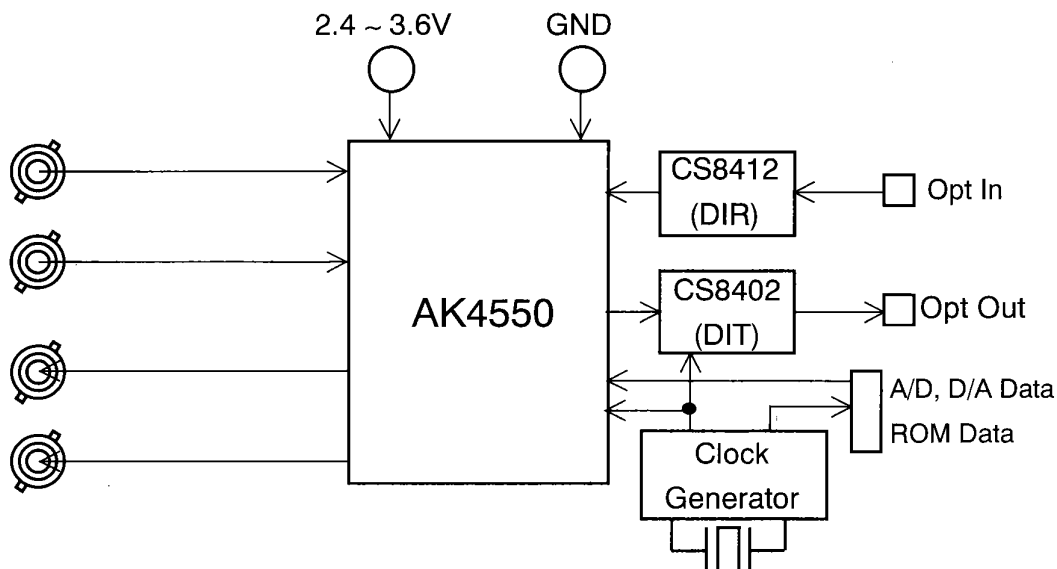

Figure 1. AKD4550 Block Diagram

■ Input Circuit

External analog signal fed through the BNC connector is terminated by a resistor of 560 ohms. The resistor value should be properly selected in order to meet the output impedance of the signal source.

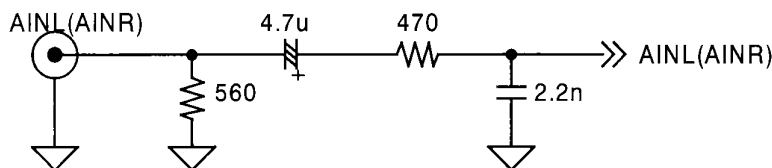

Figure 2. Input buffer circuit on board

* AKM assumes no responsibility for the trouble when using the circuit examples.

■ Analog Output Circuit

The AK4550 includes a combination of switched-capacitor filter (SCF) and continuous-time filter (CTF), so any external filters are not required.

■ Grounding and Power Supply Decoupling

To minimize the coupling by digital noise, VDD pin should be supplied from analog power supply in system. Decoupling capacitors should be connected to AK4550 as near as possible. Especially, the capacitor between VDD and VSS pins should be connected nearest.

■ Operation sequence

1) Set up the power supply lines.

[VA] (orange)	= 2.4 ~ 3.6V	: for VDD of AK4550
[VP] (orange)	= 2.4 ~ 3.6V	: for VP of 74HC4050
[VD] (red)	= 3.6 ~ 5.0V	: for logic
[AGND] (black)	= 0V	: for analog ground (including VSS of AK4550)
[DGND] (black)	= 0V	: for logic ground

Each supply line should be distributed from the power supply unit.
VP and VA must be same voltage level.

2) Set up the evaluation mode, jumper pins and DIP switches. (See the followings.)

3) Power on.

The AK4550 should be reset once bringing SW1,2 ($\overline{\text{PWAD}}$, $\overline{\text{PWDA}}$) “OFF” upon power-up.

■ Evaluation mode

Applicable Evaluation Mode

- 1) Evaluation of loopback mode (default)
- 2) Evaluation of D/A using ideal sin wave generated by ROM data
- 3) Evaluation of D/A using A/D converted data
- 4) Evaluation of D/A using DIR (Optical Link)
- 5) Evaluation of A/D using D/A converted data
- 6) Evaluation of A/D using DIT (Optical Link)
- 7) All interface signals including master clock are fed externally.

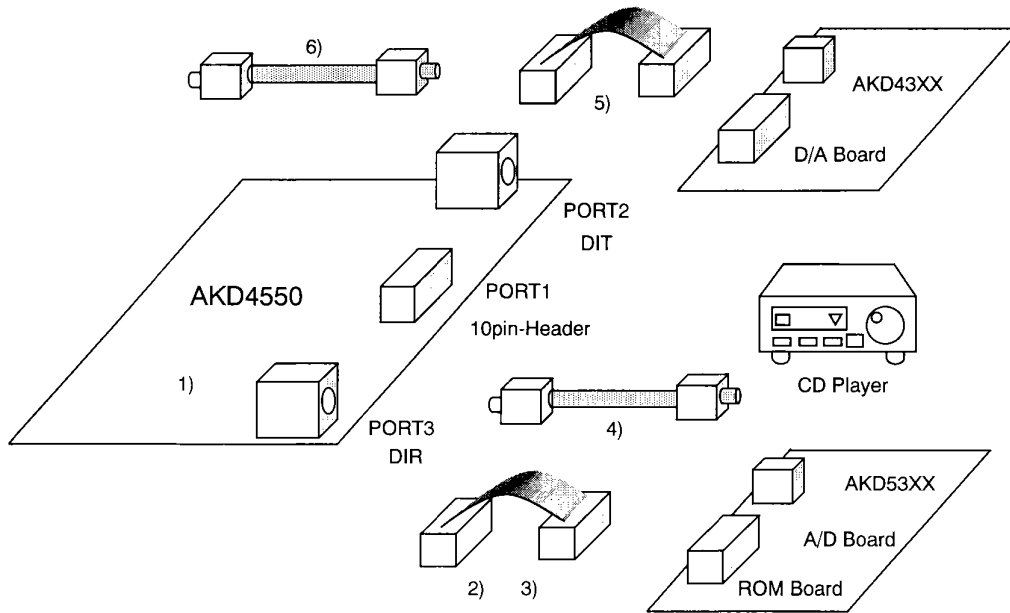

1) Evaluation of loopback mode. (default)

Nothing should be connected to PORT1/PORT3. In case of using external clock through a BNC connector (J5), select EXT on JP12 (XTI) and short JP10 (XTE). This mode corresponds to only JP13 (X_SCLK) 32fs.

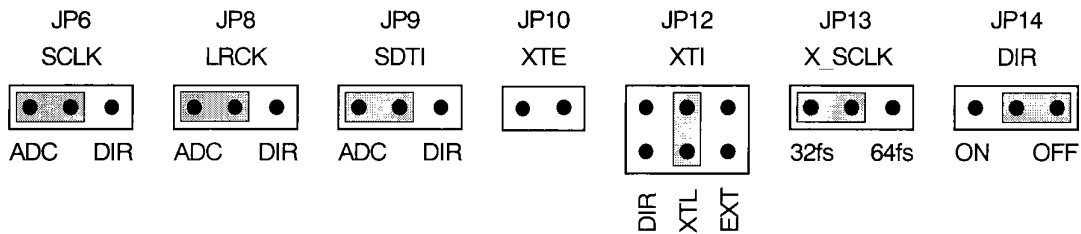

2) Evaluation of D/A using A/D converted data from ideal sine wave generated by ROM data.

Digital signals generated by AKD43XX are used. PORT1 is used for the interface with AKD43XX. Master clock is sent from AKD4550 to AKD43XX and SCLK, LRCK, SDTI are sent from AKD43XX to AKD4550. Nothing should be connected to PORT3. In case of using external clock through a BNC connector (J5), select EXT on JP12 (XTI) and short JP10 (XTE).

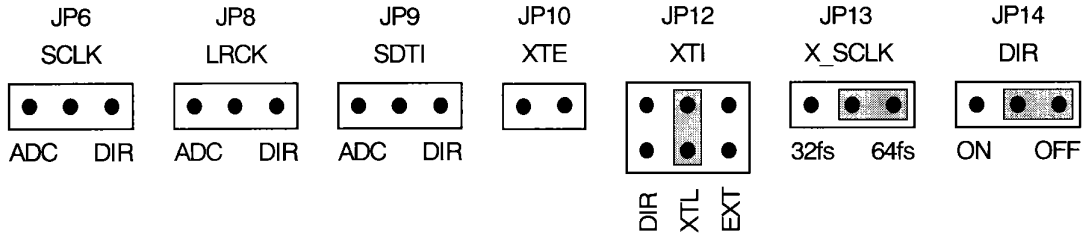

3) Evaluation of D/A using A/D converted data.

It is possible to make evaluation in the form of analog inputs and analog outputs by interfacing with various AKM's A/D evaluation boards with PORT1. Nothing should be connected to PORT3. In case of using external clock through a BNC connector (J5), select EXT on JP12 (XTI) and short JP10 (XTE).

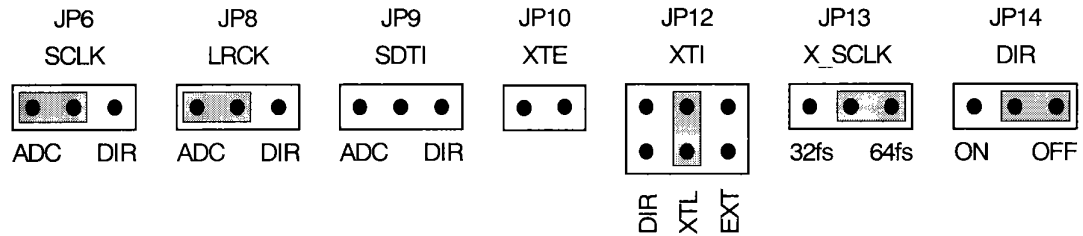

4) Evaluation of D/A using DIR. (Optical link)

PORT3 (TORX176) is used. DIR generates MCLK, SCLK, LRCK and SDATA from the received data through optical connector (TORX176). Used for the evaluation using CD test disk. Nothing should be connected to PORT1/PORT2.

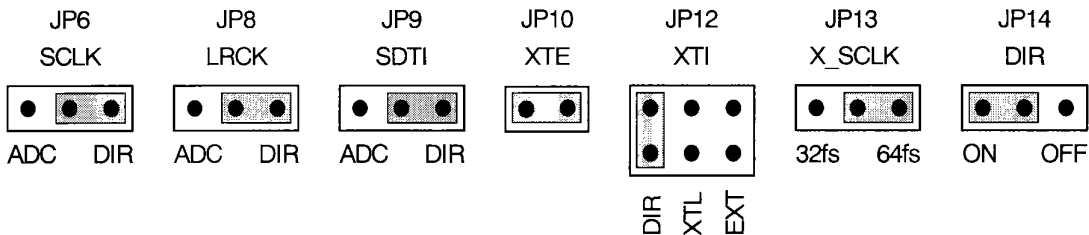

5) Evaluation of A/D using D/A converted data.

It is possible to make evaluation in the form of analog inputs and analog outputs by interfacing with various AKM's D/A evaluation boards with PORT1. Nothing should be connected to PORT3.

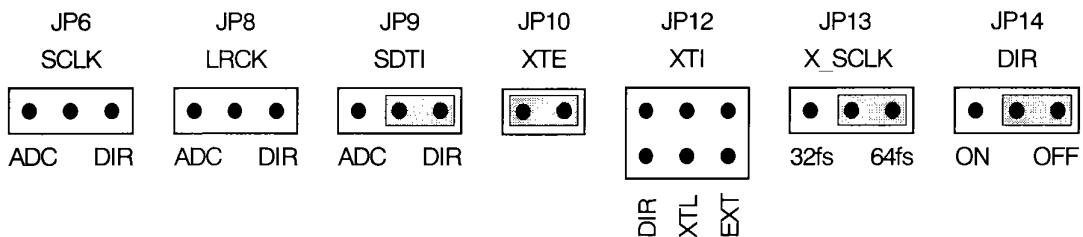

6) Evaluation of A/D using DIT. (Optical link)

PORT2 (TOTX176) is used. DIT generates audio bi-phase signal from received data and which is output through optical connector (TOTX176). It is possible to connect AKM's D/A converter evaluation boards on the digital-amplifier which equips DIR input. In case of using external clock through a BNC connector (J5), select EXT on JP12 (XTI) and short JP10 (XTE).

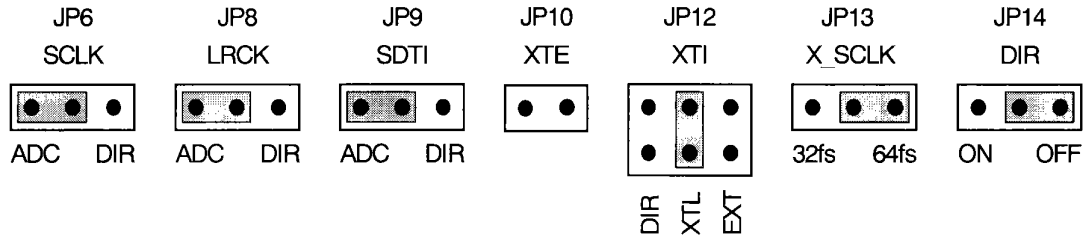

7) All interfacing signals (MCLK, SCLK, LRCK) are fed from the external circuit through PORT1.

Under the following set-up, all external signals needed for the AK4550 to operate could be fed through PORT1. In case of interfacing external sources to D/A converter, JP9 (SDTI) should be open. And in case of using A/D data to externally, JP9 (SDTI) is set ADC side. When JP9 (SDTI) is open, the A/D data can be output from the SDTO pin of PORT1 at the same time if JP7 (SDTO) is short.

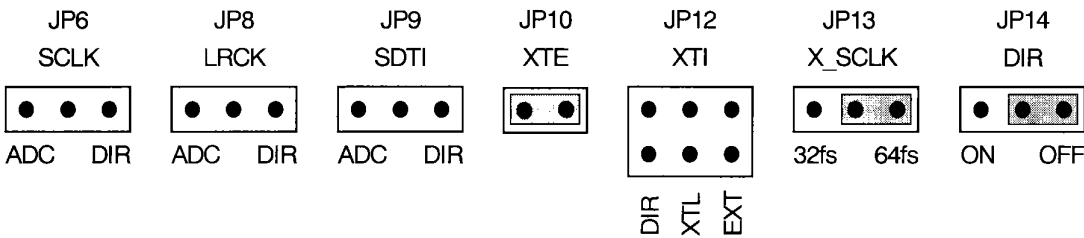

■ DIP switch set up

Upper-side is “ON” (“H”) and lower-side is “OFF” (“L”).

[SW3]: Sets the C-bit of CS8402. (Default is the consumer mode.)

This set up does not affect the evaluation of the AK4550. In case of using DIT, need to set it up correctly. For more detailed configurations, please refer to the CS8402 data sheet.

Switch	OFF=0, ON=1	Contents
8	PRO = 0	Professional mode, C0=1
7, 6	C6, C7	C6,C7 – Sampling frequency
	11	00 – Not indicated. Receiver default to 48kHz.
	10	01 – 48kHz
	01	10 – 44.1kHz
	00	11 – 32kHz
5	C9	C8,C9,C10,C11 – 1bit of channel mode
	1	0000 – Mode not indicated. Receiver default to 2-channel mode.
	0	0100 – Stereophonic.
4	C1	C1 – Audio mode
	1	0 – Normal audio
	0	1 – Non-audio
3	TRNPT	Transparent mode *CS8402 is CRE
	0	Normal mode
	1	Transparent mode
2, 1	EM1, EM0	C2,C3,C4 – Encoded audio signal emphasis
	11	000 – Emphasis not indicated. Receiver defaults to no emphasis with manual override enabled.
	10	100 – None
	01	110 – 50/15usec
	00	111 – CCITT J.17

Table 1. DIP switch set-up of CS8402 (Professional mode)

Switch	OFF=0, ON=1	Contents
8	PRO = 1	Consumer mode, C0=1 <Default>
7	C2	C2 – Copy
	1	0 – Copy inhibited
Default	0	1 – Copy permitted
6	C3	C3,C4,C5 – Pre-emphasis
Default	1	000 – None
	0	100 – 50/15usec
5	C15	C15 – General Status
	1	0 – See the standard
Default	0	1 – See the standard
4, 3	FC1,FC0	C24,C25,C26,C27 – Sampling frequency
	00	0000 – 44.1kHz
	01	0100 – 48kHz
Default	10	1100 – 32kHz
	11	0000 – 44.1kHz, CD mode
2, 1	C8, C9	C8-C14 – Category code
Default	11	0000000 – General
	10	0100000 – PCM encoder/decoder
	01	1000000 – CD
	00	1100000 – DAT

Table 2. DIP switch set-up of CS8402 (Consumer mode; default)

■ Other jumper pins set up

[JP1] (GND): Analog ground and digital ground
 open: separated <default>
 AGND and DGND are connected near to AK4550 on the board.

[JP2] (VP-VD): VP and VD
 open: separated <default>
 short: common (The connector “VP” can be open.)

[JP3, 4] (DEM0, DEM1): Set up the de-emphasis of AK4550

DEM1 (JP3)	DEM0 (JP4)	Mode
open	open	44.1kHz
open	short	OFF
short	open	48kHz
short	short	32kHz

Table 3. Set up the de-emphasis of AK4550

[JP5] (SCLK2): Phase of SCLK
 THR: SCLK is coincides with AK4550. <default>
 INV: SCLK is inverted.

[JP7] (SDTO): SDTO of AK4550
 Always open. It is possible to short for evaluation mode 7.

[JP11] (SPEED): Select of MCLK
 NORMAL: 256fs <default>
 DOUBLE: 512fs

■ The function of the toggle SW.

Upper-side is “ON” and lower-side is “OFF”.

- [SW1] (PWDA): Resets the D/A of AK4550. Keep “ON” during normal operation.
- [SW2] (PWAD): Resets the A/D of AK4550. Keep “ON” during normal operation.
- [SW4] (DIT_RST): Resets the CS8402. “OFF” resets the internal counter of CS8402, then Bi-phase signal is not output. Keep “ON” during normal operation.

■ Indication for LED

- [LED1]: Indicate whether the input data of CS8412 is pre-emphasized or not.
- [LED2] (VERF): Monitor VERF pin of the CS8412. LED turns on when some error has occurred to CS8412.

MEASUREMENT RESULTS

[Measurement condition]

- Measurement unit: Audio Precision, System two
- MCLK : 256fs
- SCLK : 32fs (ADC), 64fs (ADC, DAC)
- fs : 32kHz, 44.1kHz, 48kHz
- Bit : 16bit
- Power Supply : VDD = VP = 2.5V, VD = 5V
- Interface : DIT/DIR
- Temperature : Room

1. ADC

(1) SCLK = 32fs

VDD	Parameter	Measured Filter	fs = 32kHz	fs = 44.1kHz	fs = 48kHz
2.5V	S/(N+D) (-0.5dBFS)	20kHz LPF	84.8 dB	78.9 dB	79.1 dB
	D-Range (-60dBFS)	20kLPF + A-weighted	88.6 dB	89.6 dB	89.6 dB
	S/N (0 data)	20kLPF + A-weighted	88.5 dB	89.6 dB	89.6 dB
3.0V	S/(N+D) (-0.5dBFS)	20kHz LPF	83.3 dB	78.7 dB	78.6 dB
	D-Range (-60dBFS)	20kLPF + A-weighted	89.8 dB	90.7 dB	90.8 dB
	S/N (0 data)	20kLPF + A-weighted	89.7 dB	90.5 dB	90.2 dB
3.6V	S/(N+D) (-0.5dBFS)	20kHz LPF	81.2 dB	78.5 dB	78.0 dB
	D-Range (-60dBFS)	20kLPF + A-weighted	91.0 dB	91.9 dB	91.9 dB
	S/N (0 data)	20kLPF + A-weighted	91.0 dB	90.8 dB	90.2 dB

(2) SCLK = 64fs

VDD	Parameter	Measured Filter	fs = 32kHz	fs = 44.1kHz	fs = 48kHz
2.5V	S/(N+D) (-0.5dBFS)	20kHz LPF	81.2 dB	81.6 dB	81.7 dB
	D-Range (-60dBFS)	20kLPF + A-weighted	88.6 dB	89.7 dB	89.8 dB
	S/N (0 data)	20kLPF + A-weighted	88.6 dB	89.7 dB	89.9 dB
3.0V	S/(N+D) (-0.5dBFS)	20kHz LPF	80.3 dB	80.7 dB	80.8 dB
	D-Range (-60dBFS)	20kLPF + A-weighted	89.9 dB	90.9 dB	91.1 dB
	S/N (0 data)	20kLPF + A-weighted	89.9 dB	90.9 dB	91.1 dB
3.6V	S/(N+D) (-0.5dBFS)	20kHz LPF	79.2 dB	79.6 dB	79.7 dB
	D-Range (-60dBFS)	20kLPF + A-weighted	91.0 dB	92.0 dB	92.3 dB
	S/N (0 data)	20kLPF + A-weighted	91.0 dB	92.0 dB	92.3 dB

2. DAC

(1) SCLK = 64fs

VDD	Parameter	Measured Filter	fs = 32kHz	fs = 44.1kHz	fs = 48kHz
2.5V	S/(N+D) (0dBFS)	20kHz LPF	88.3 dB	87.5 dB	87.4 dB
	D-Range (-60dBFS)	22kLPF + A-weighted	92.1 dB	92.5 dB	92.8 dB
	S/N (0 data)	22kLPF + A-weighted	92.8 dB	93.2 dB	93.4 dB
3.0V	S/(N+D) (0dBFS)	20kHz LPF	89.7 dB	89.6 dB	89.4 dB
	D-Range (-60dBFS)	22kLPF + A-weighted	93.5 dB	93.8 dB	94.1 dB
	S/N (0 data)	22kLPF + A-weighted	94.7 dB	94.9 dB	95.0 dB
3.6V	S/(N+D) (0dBFS)	20kHz LPF	91.0 dB	91.3 dB	91.3 dB
	D-Range (-60dBFS)	22kLPF + A-weighted	94.8 dB	95.2 dB	95.3 dB
	S/N (0 data)	22kLPF + A-weighted	96.3 dB	96.6 dB	96.6 dB

3.Graph

(1) ADC

AKM

AK4550 Rev.B ADC THD+N vs Input Level
 VDD=2.5V, SCLK=64fs, fs=44.1 kHz

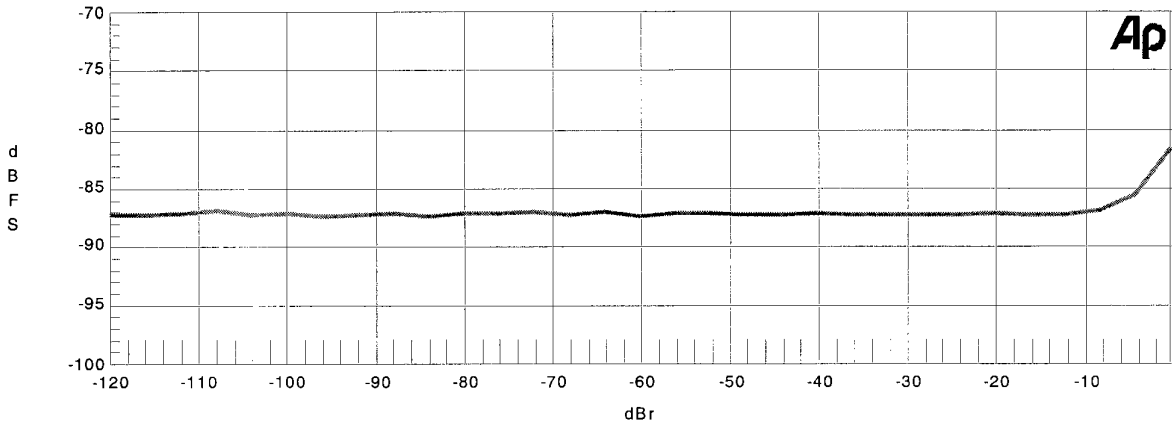

Color	Line Style	Thick	Data	Axis
Red	Solid	3	DSP Audio Anlr.TH+D+N Ampl	Left

last.at2

AKM

AK4550 Rev.B ADC THD+N vs Input Frequency
 VDD=2.5V, SCLK=64fs, fs=44.1 kHz

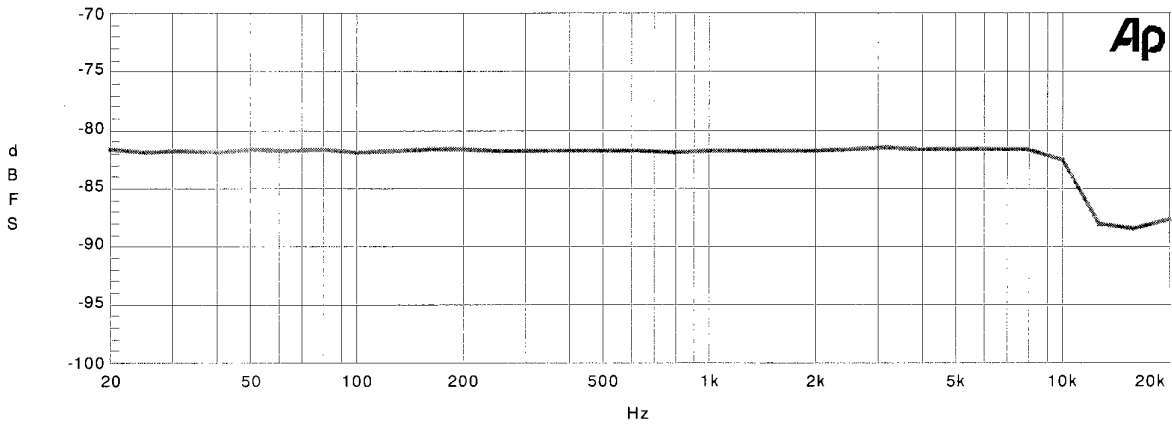

Color	Line Style	Thick	Data	Axis
Red	Solid	3	DSP Audio Anlr.TH+D+N Ampl	Left

last.at2

AKM

AK4550 Rev.B ADC Linearity
VDD=2.5V, SCLK=64fs, fs=44.1 kHz

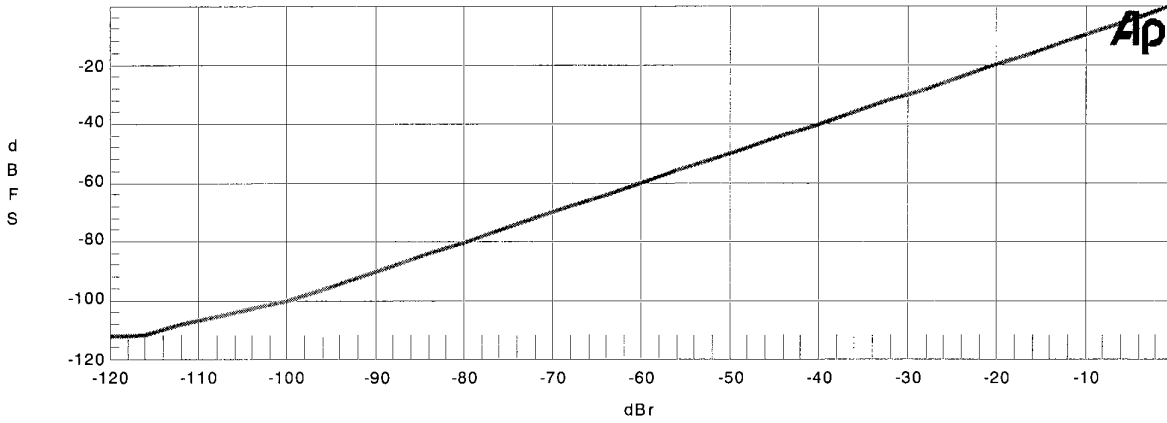

Color	Line Style	Thick	Data	Axis
Red	Solid	3	DSP Audio Anlr.Bandpass	Left

last.at2

AKM

AK4550 Rev.B ADC Frequency Response
VDD=2.5V, SCLK=64fs, fs=44.1 kHz, Input=-0.5dBr

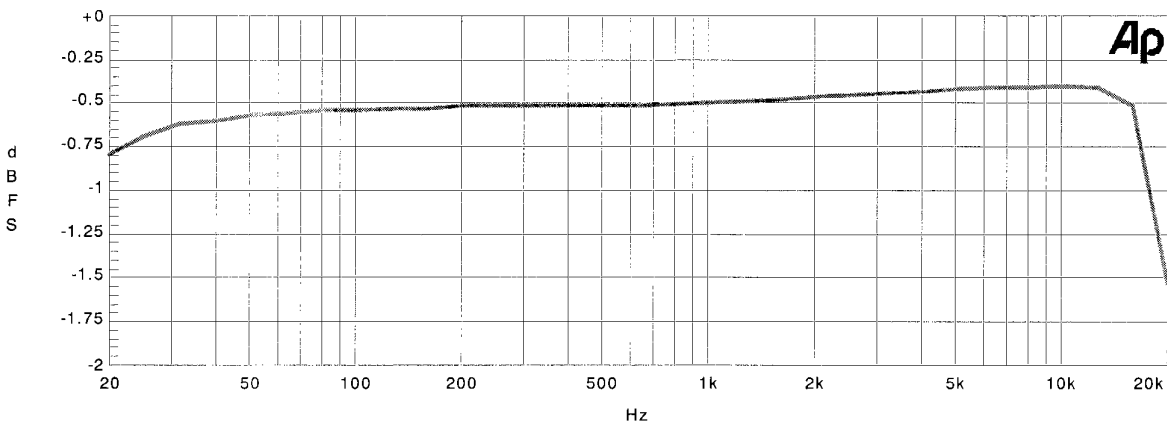

Color	Line Style	Thick	Data	Axis
Red	Solid	3	DSP Audio Anlr.Bandpass	Left

last.at2

AKM

AK4550 Rev.B ADC Crosstalk
VDD=2.5V, SCLK=64fs, fs=44.1kHz

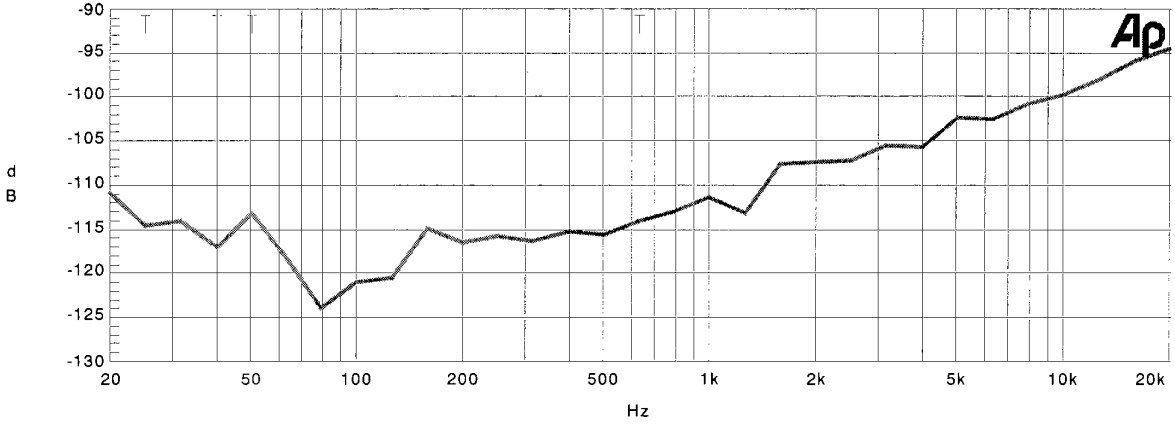

AKM

AK4550 Rev.B ADC FFT Plot
VDD=2.5V, SCLK=64fs, fs=44.1kHz, Input=-0.5dB

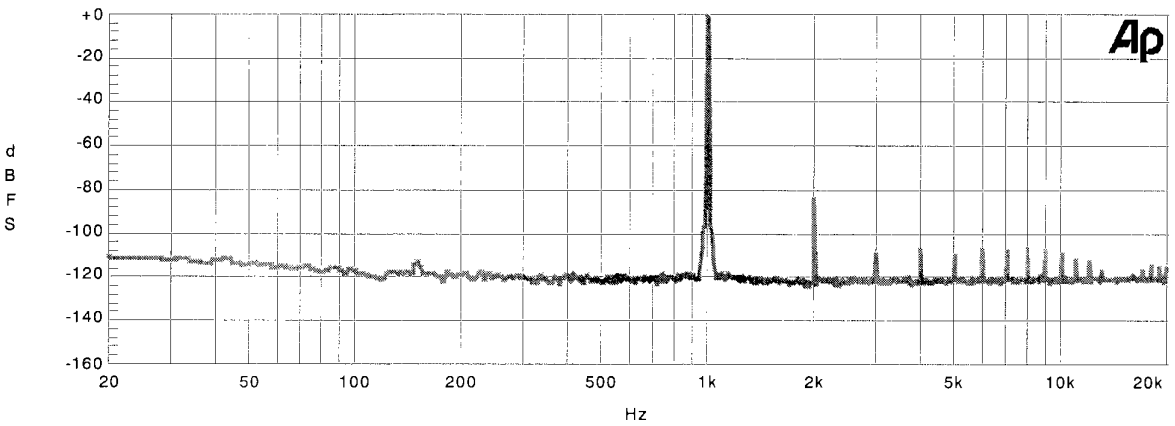

AKM

AK4550 Rev.B ADC FFT Plot
VDD=2.5V, SCLK=64fs, fs=44.1kHz, Input=-60dB

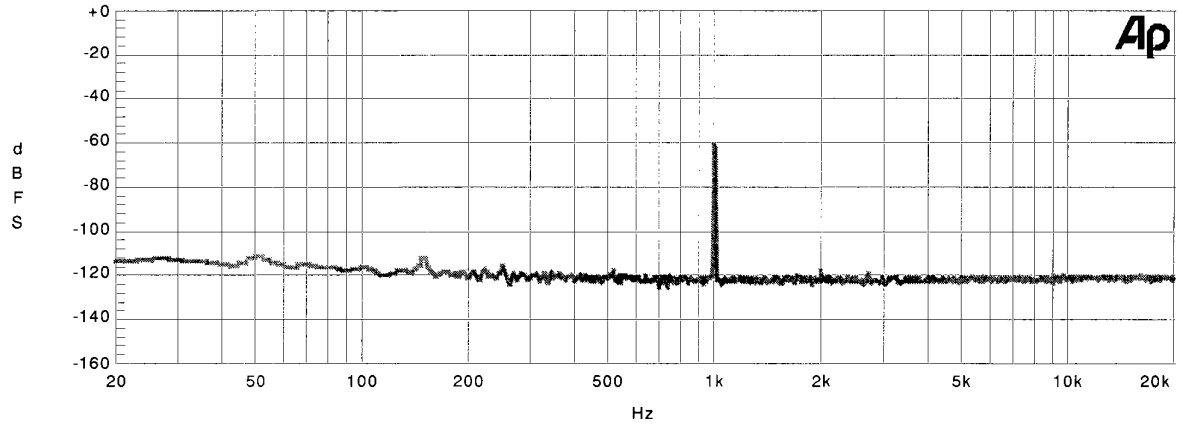

Color	Line Style	Thick	Data	Axis
Red	Solid	3	Fft.Ch.1 Ampl	Left

last.at2

AKM

AK4550 Rev.B ADC FFT Plot
VDD=2.5V, SCLK=64fs, fs=44.1kHz, Input=None

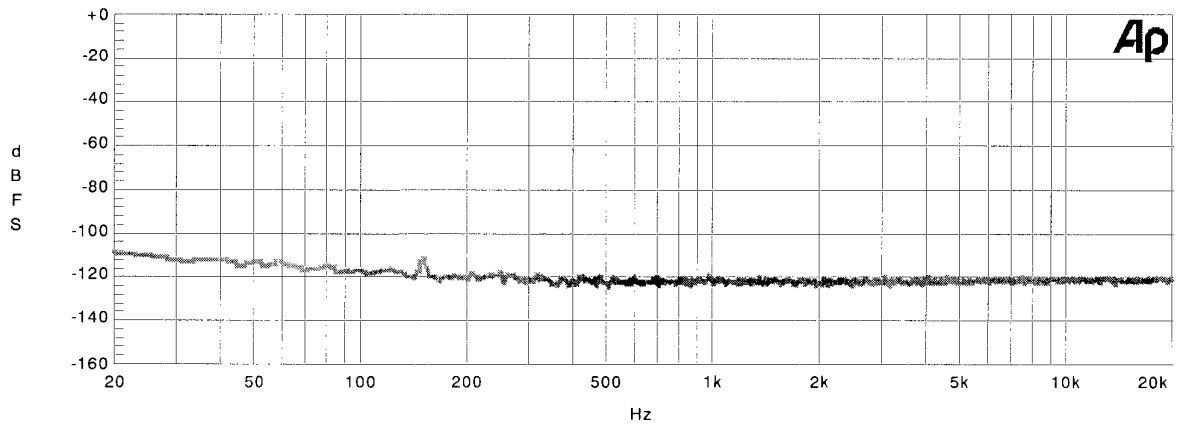

Color	Line Style	Thick	Data	Axis
Red	Solid	3	Fft.Ch.1 Ampl	Left

last.at2

(2) DAC

AKM

AK4550 Rev.B DAC THD+N vs Input Level
VDD=2.5V, SCLK=64fs, fs=44.1 kHz

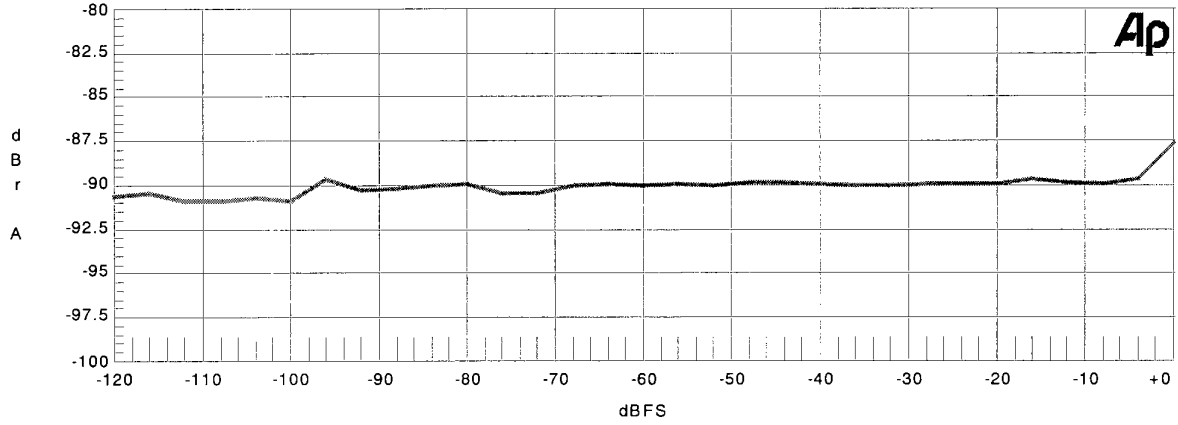

Color	Line Style	Thick	Data	Axis
Red	Solid	3	Anlr.TH+D+N Ampl	Left

last.at2

AKM

AK4550 Rev.B DAC THD+N vs Input Frequency
VDD=2.5V, SCLK=64fs, fs=44.1 kHz

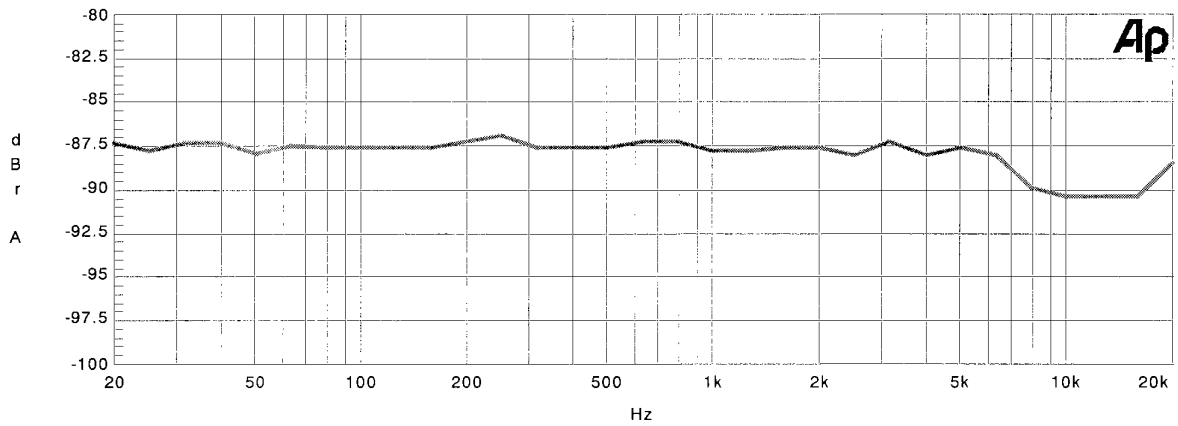

Color	Line Style	Thick	Data	Axis
Red	Solid	3	Anlr.TH+D+N Ampl	Left

last.at2

AKM

AK4550 Rev.B DAC Linearity
VDD=2.5V, SCLK=64fs, fs=44.1kHz

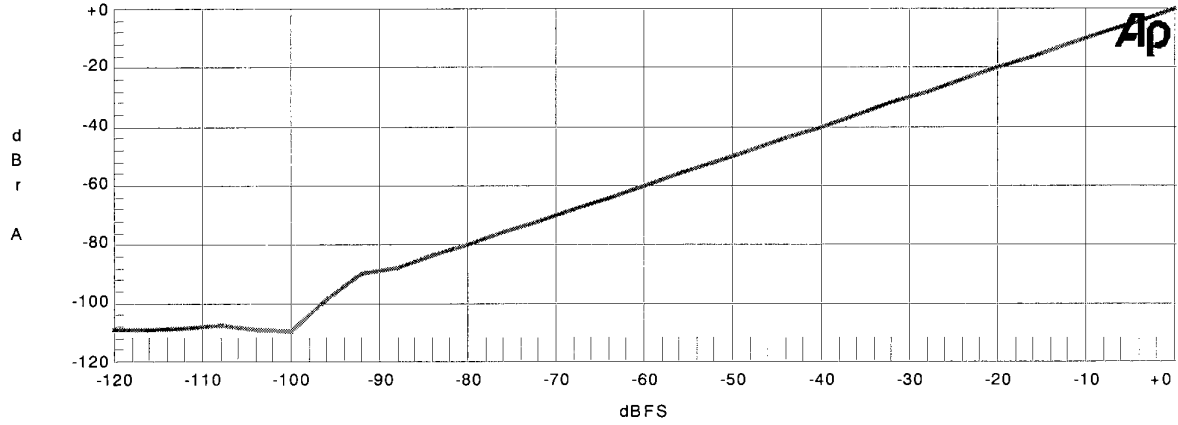

Color	Line Style	Thick	Data	Axis
Red	Solid	3	Anlr.Bandpass	Left

last.at2

AKM

AK4550 Rev.B DAC Frequency Response
VDD=2.5V, SCLK=64fs, fs=44.1kHz, Input=0dBFS

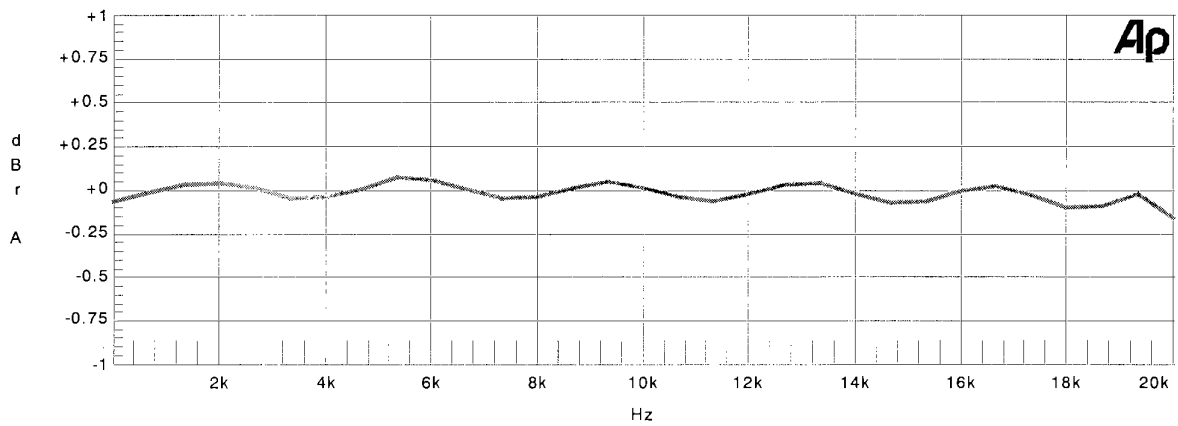

Color	Line Style	Thick	Data	Axis
Red	Solid	3	Anlr.Bandpass	Left

last.at2

AKM

AK4550 Rev.B DAC Crosstalk
VDD=2.5V, SCLK=64fs, fs=44.1kHz

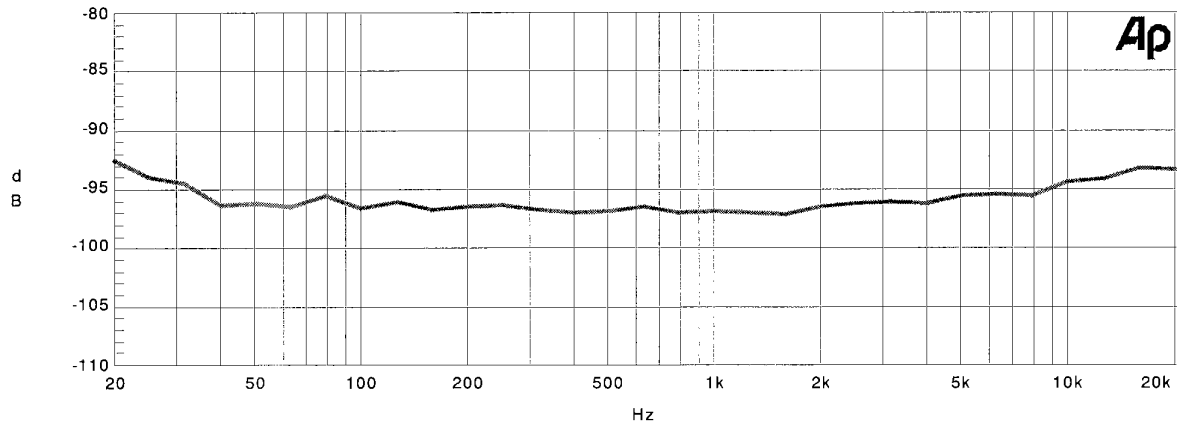

Color	Line Style	Thick	Data	Axis
Red	Solid	3	Anlr.Crosstalk	Left

last.at2

AKM

AK4550 Rev.B DAC FFT Plot
VDD=2.5V, SCLK=64fs, fs=44.1kHz, Input=0dBFS

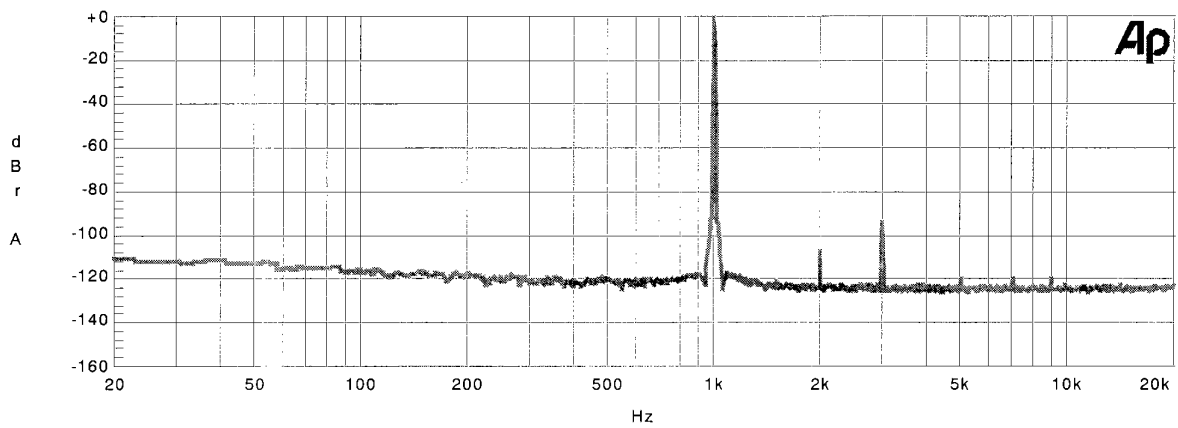

Color	Line Style	Thick	Data	Axis
Red	Solid	3	Fft.Ch.1 Ampl	Left

last.at2

AKM

AK4550 Rev.B DAC FFT Plot
VDD=2.5V, SCLK=64fs, fs=44.1kHz, Input=-60dBFS

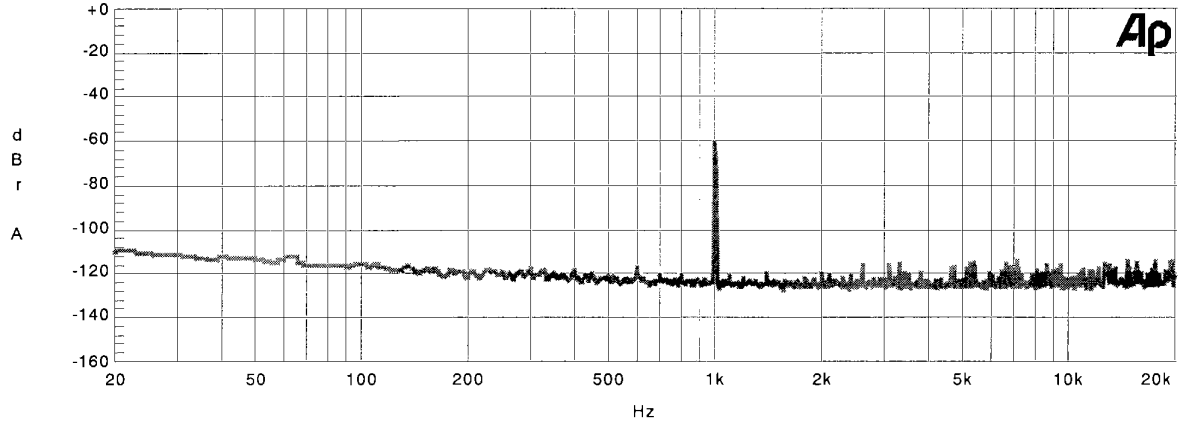

Color	Line Style	Thick	Data	Axis
Red	Solid	3	Fft.Ch.1 Ampl	Left

last.at2

AKM

AK4550 Rev.B DAC FFT Plot
VDD=2.5V, SCLK=64fs, fs=44.1kHz, Input=None

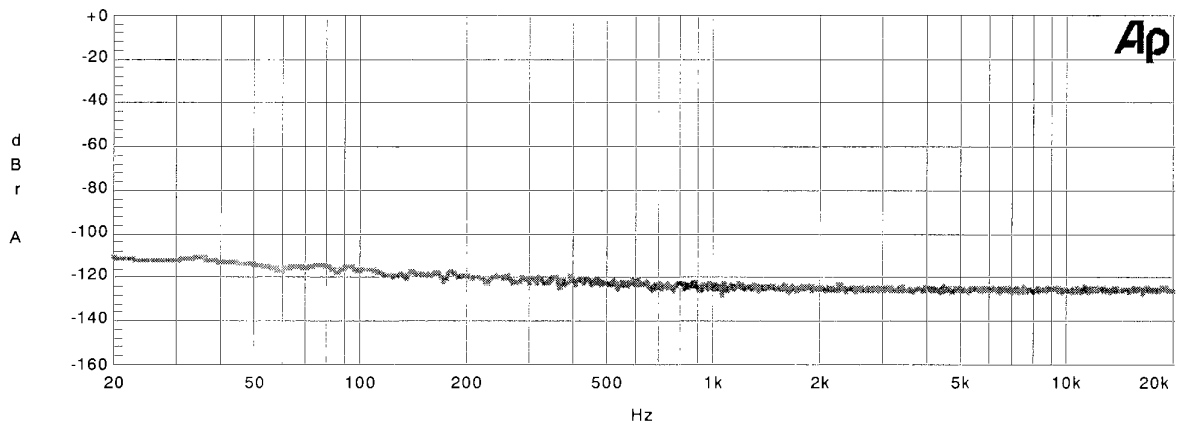

Color	Line Style	Thick	Data	Axis
Red	Solid	3	Fft.Ch.1 Ampl	Left

last.at2

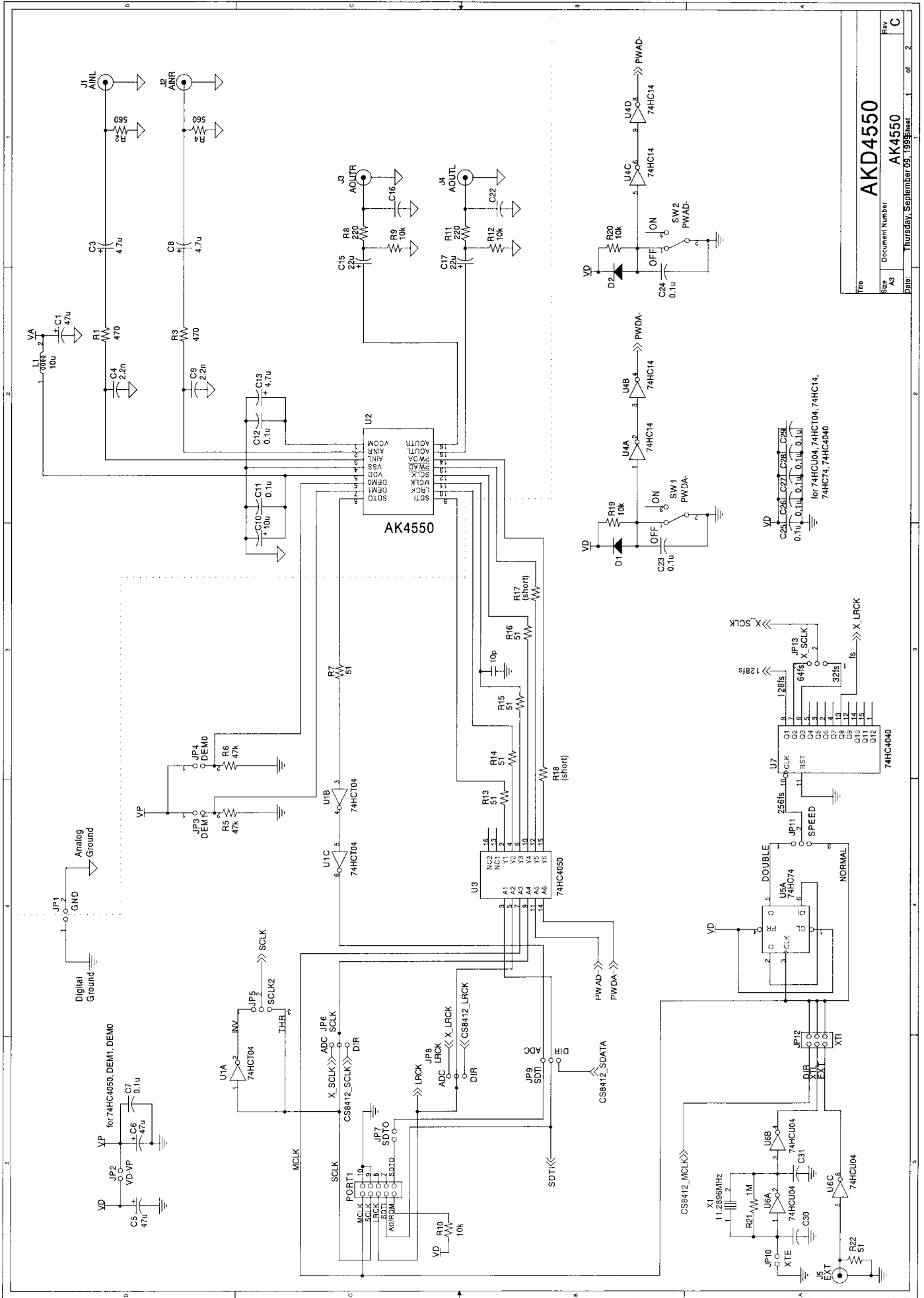

AKD4550

Document Number
AK4550

Thursday, September 09, 1998

File Size A3

Print

Page 1 of 2

Rev C

C25L_C26L_C27L_C28L_C29L
0.1u 0.1u 0.1u 0.1u 0.1u
for 74HCU04, 74HCT04, 74HC14,
74HCT74, 74HC4040

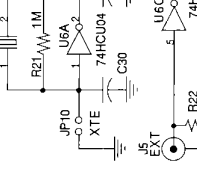
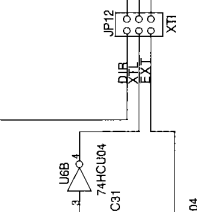
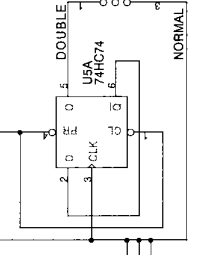
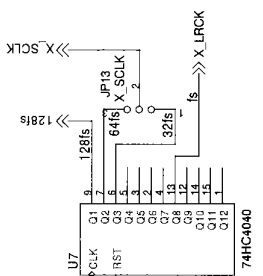

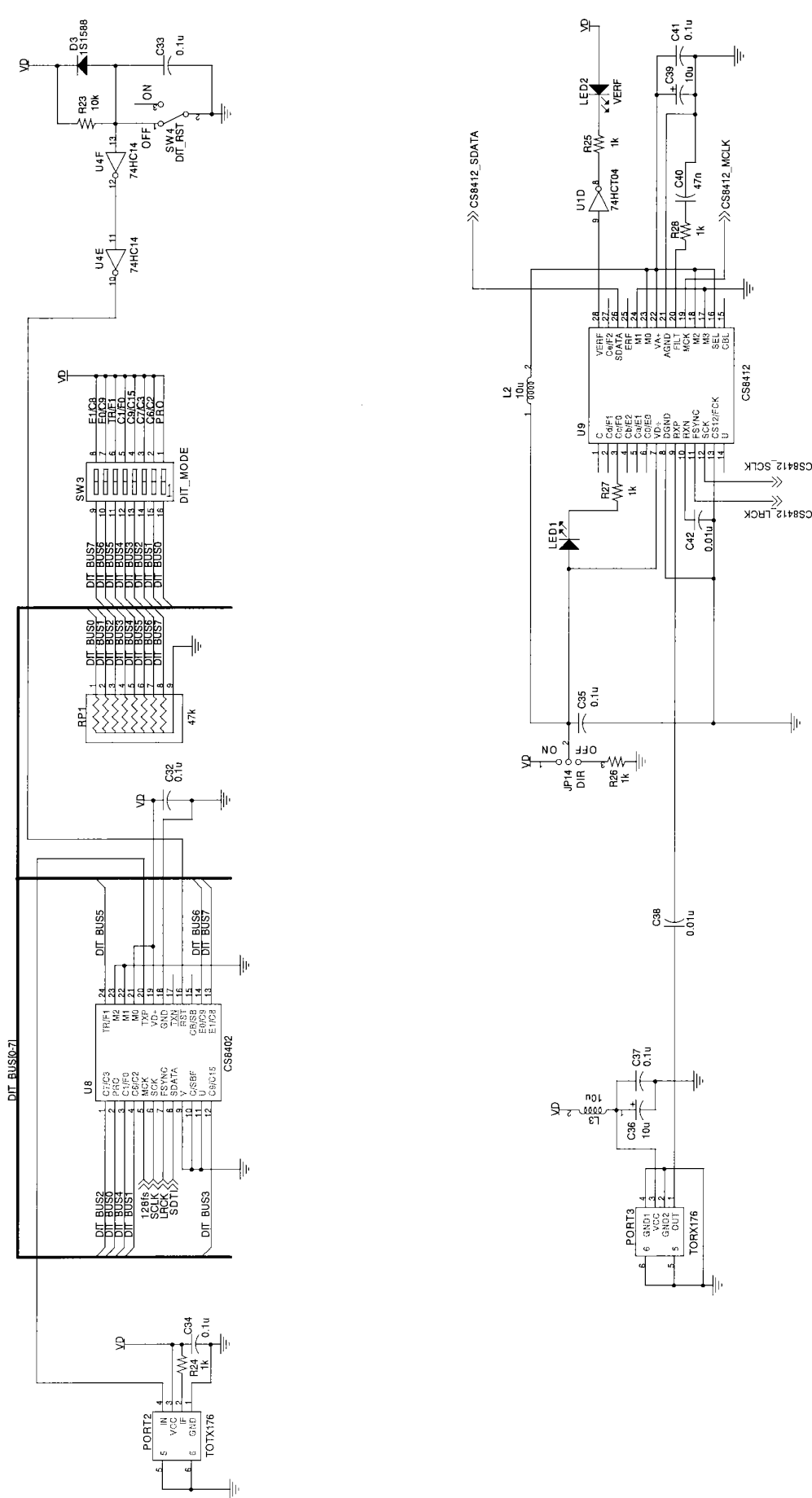

Title		AKD4550	
Document Number		Interface	
Size	A3	Sheet	2 of 2
Date	Thursday, June 24, 1999	Rev	C

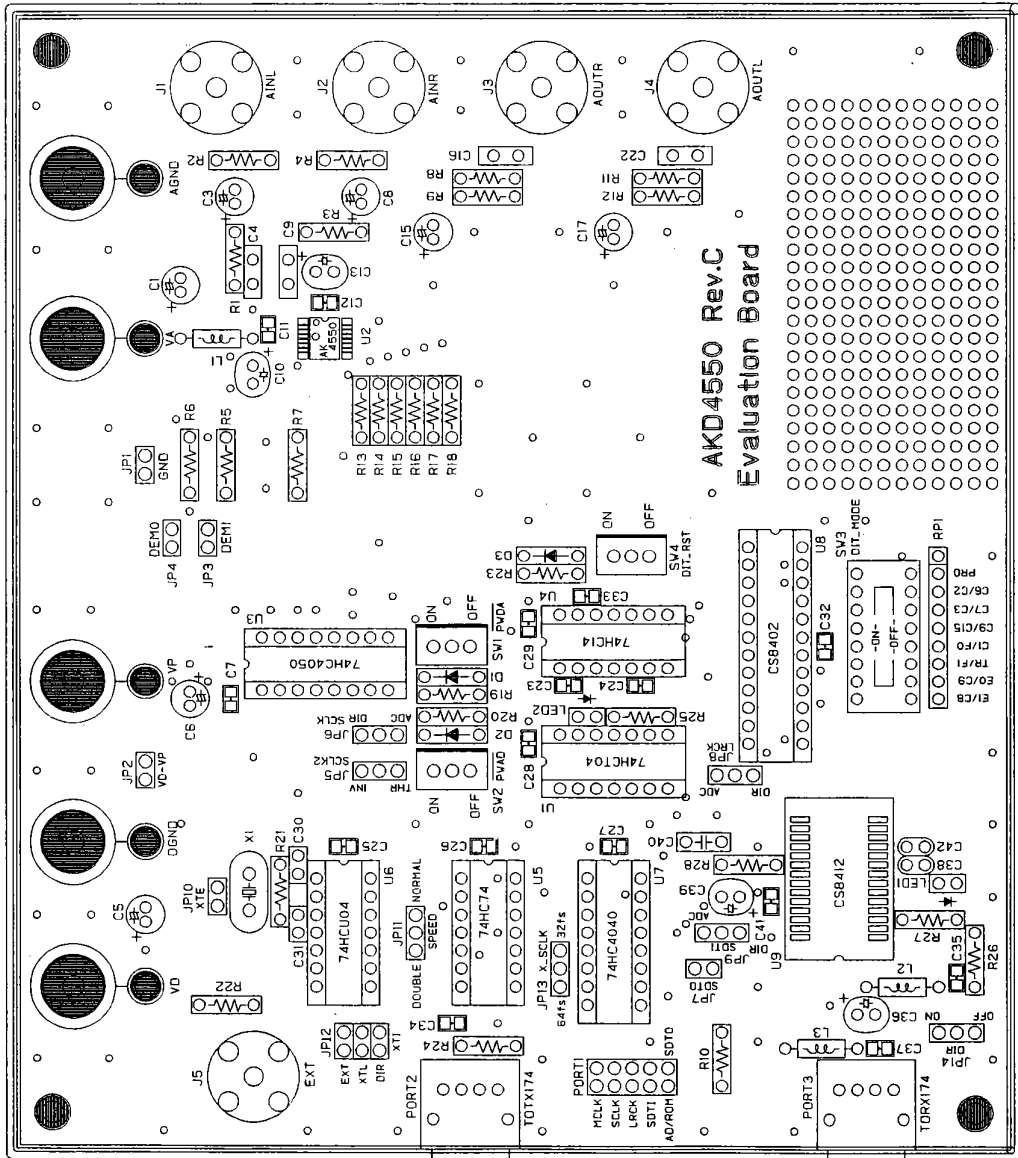

LI 仕様書 AKD4550 RevC

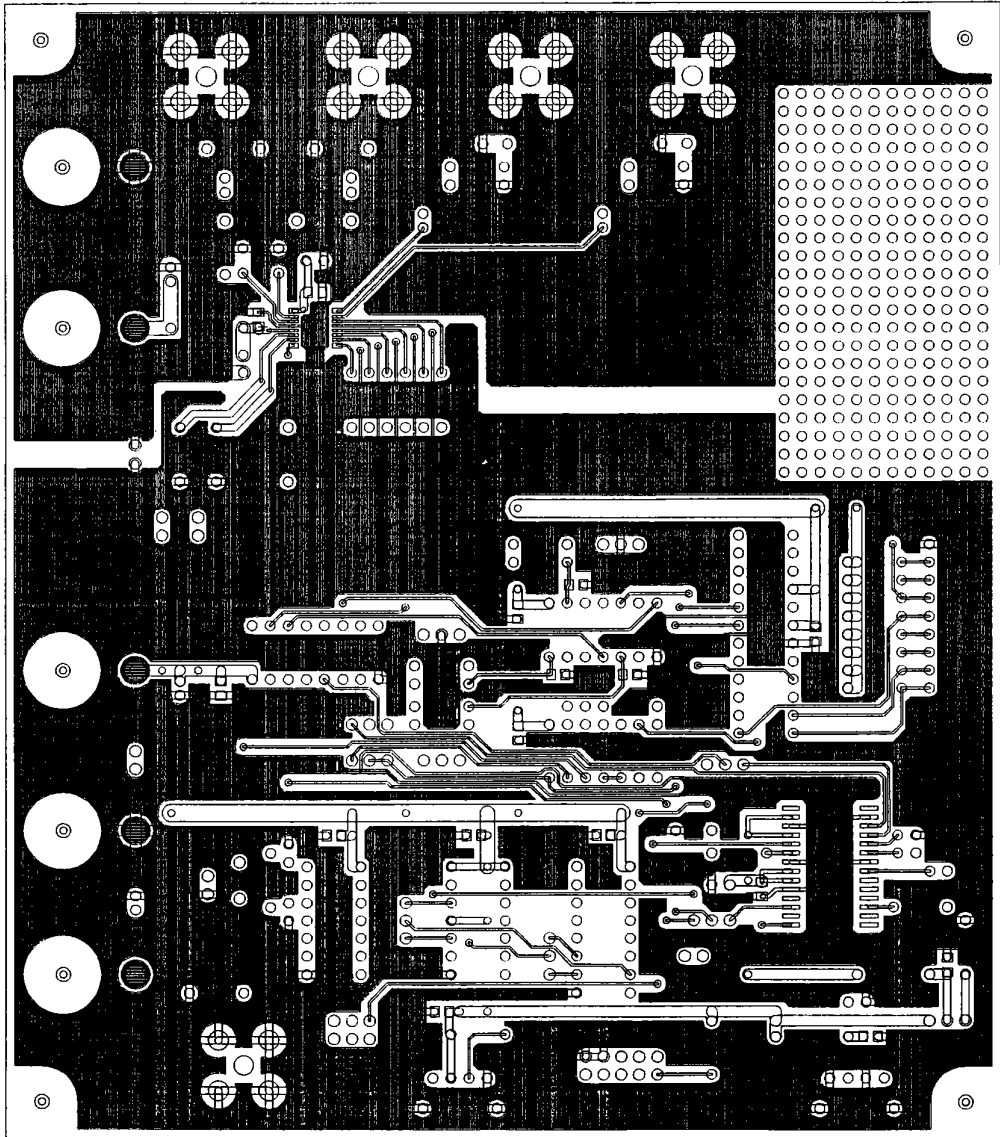

L1 部品面 AKD4550 RevC

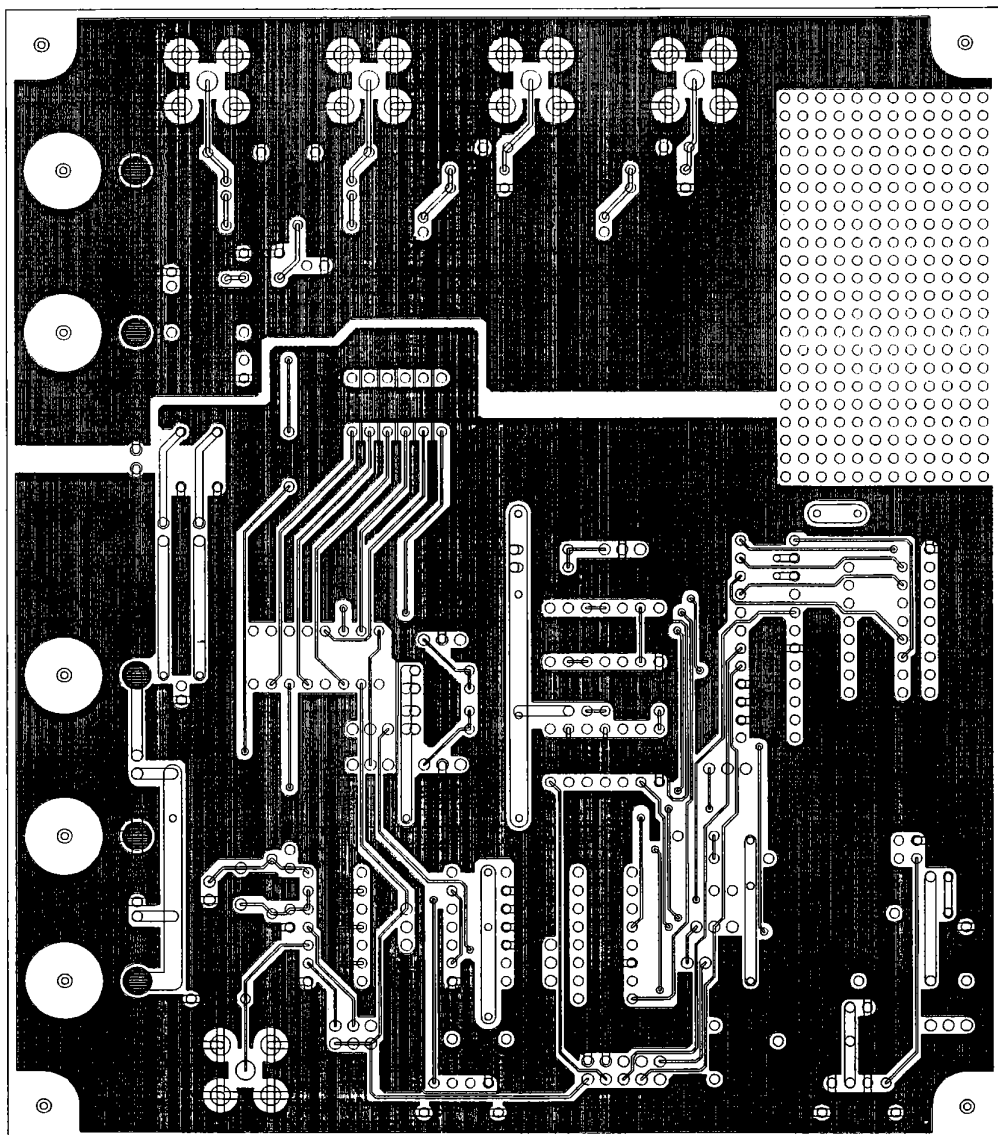

FS 井田 画 VKD7220 R6AC

IMPORTANT NOTICE

- These products and their specifications are subject to change without notice. Before considering any use or application, consult the Asahi Kasei Microsystems Co., Ltd. (AKM) sales office or authorized distributor concerning their current status.
- AKM assumes no liability for infringement of any patent, intellectual property, or other right in the application or use of any information contained herein.
- Any export of these products, or devices or systems containing them, may require an export license or other official approval under the law and regulations of the country of export pertaining to customs and tariffs, currency exchange, or strategic materials.
- AKM products are neither intended nor authorized for use as critical components in any safety, life support, or other hazard related device or system, and AKM assumes no responsibility relating to any such use, except with the express written consent of the Representative Director of AKM. As used here:
 - (a) A hazard related device or system is one designed or intended for life support or maintenance of safety or for applications in medicine, aerospace, nuclear energy, or other fields, in which its failure to function or perform may reasonably be expected to result in loss of life or in significant injury or damage to person or property.
 - (b) A critical component is one whose failure to function or perform may reasonably be expected to result, whether directly or indirectly, in the loss of the safety or effectiveness of the device or system containing it, and which must therefore meet very high standards of performance and reliability.
- It is the responsibility of the buyer or distributor of an AKM product who distributes, disposes of, or otherwise places the product with a third party to notify that party in advance of the above content and conditions, and the buyer or distributor agrees to assume any and all responsibility and liability for and hold AKM harmless from any and all claims arising from the use of said product in the absence of such notification.