

General-purpose Operational Amplifiers / Comparators

SIGNATURE SERIES

Operational Amplifiers



LM358DT/PT/ST/WDT/WPT, LM2904DT/PT/ST/WDT/WPT
LM324DT/PT/WDT, LM2902DT/PT/WDT

No.11094EBT05

Description

The Universal Standard family LM358 / 324, LM2904 / 2902 monolithic ICs integrate two independent op-amps and phase compensation capacitors on a single chip and feature high-gain, low power consumption, and an operating voltage range of 3[V] to 32[V] (single power supply.)

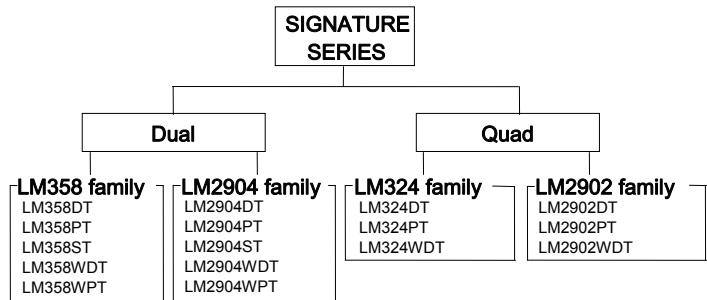

Features

- Operating temperature range
Commercial Grade LM358/324 family : 0[°C] to + 70[°C]
Extended Industrial Grade LM2904/2902 family : -40[°C] to +125[°C]
- Wide operating supply voltage
+3[V] to +32[V] (single supply)
±1.5[V] to ±16[V] (dual supply)
- Low supply current
- Common-mode input voltage range including ground
- Differential input voltage range equal to maximum rated supply voltage
- High large signal voltage gain
- Wide output voltage range

Pin Assignment

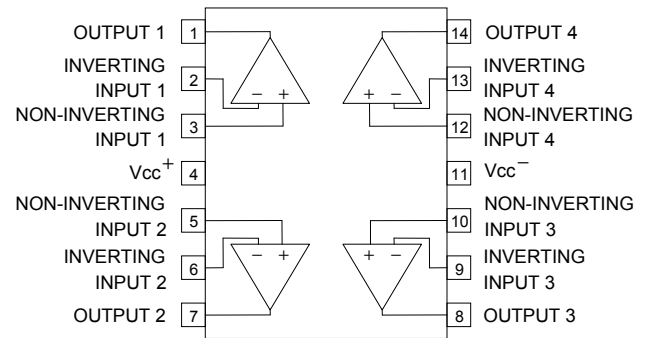
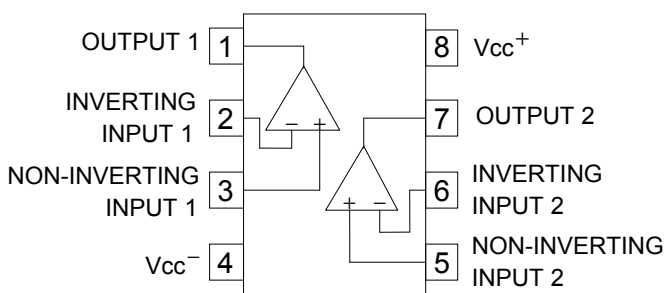

SO package8

LM358DT
LM358WDT
LM2904DT
LM2904WDT

TSSOP8

LM358PT
LM358WPT
LM2904PT
LM2904WPT

Mini SO8

LM358ST
LM2904ST

SO package14

LM324DT
LM324WDT
LM2902DT
LM2902WDT

TSSOP14

LM324PT
LM2902PT

●Absolute Maximum Ratings (Ta=25[°C])

Parameter	Symbol	Rating				Unit
		LM358 family	LM324 family	LM2904 family	LM2902 family	
Supply Voltage	VDD	+32				V
Operating Temperature Range	Topr	0 to +70		-40 to +125		°C
Storage Temperature Range	Tstg	-65 to +150				°C
Input Common-mode Voltage	VICM	-0.3 to +32				V
Maximum Junction Temperature	Tjmax	+150				°C

●Electric Characteristics

OLM358,LM324 family(Unless otherwise specified, Vcc⁺=+5[V], Vcc⁻=0[V])

Parameter	Symbol	Temperature range	Limit						Unit	Conditions	Fig. No
			LM358 family			LM324 family					
			Min.	Typ.	Max.	Min.	Typ.	Max.			
Input Offset Voltage (*1)	VIO	25°C	-	2	7	-	-	7	mV	VO=1.4[V],RS=0[Ω] 5[V]<Vcc ⁺ <30[V] 0<VICM<Vcc ⁺ -1.5[V]	98
		Full range	-	-	9	-	-	9			
Input Offset Current (*1)	IIO	25°C	-	2	30	-	2	30	nA	VO=1.4[V]	98
		Full range	-	-	-	-	-	100			
Input Bias Current (*1)	IIB	25°C	-	20	150	-	20	150	nA	VO=1.4[V]	98
		Full range	-	-	200	-	-	300			
Large Signal Voltage Gain	AVD	25°C	25	100	-	25	100	-	V/mV	Vcc ⁺ =15[V] VO=1.4[V] to 11.4[V] RL=2[kΩ]	98
Supply Voltage Rejection Ratio	SVR	25°C	65	100	-	65	110	-	dB	RS≤10[kΩ] Vcc ⁺ =5[V] to 30[V]	98
		Full range	65	-	-	65	-	-			
Supply Current (All Amp)	ICC	25°C	-	-	-	-	0.7	1.2	mA	Vcc ⁺ =5[V],No Load Vcc ⁺ =30[V],No Load Vcc ⁺ =5[V],No Load Vcc ⁺ =30[V],No Load	99
		25°C	-	-	-	-	1.5	3			
		Full range	-	0.7	1.2	-	0.8	3			
		Full range	-	-	2	-	1.5	3			
Input Common-mode Voltage Range	VICM	25°C	-	-	Vcc ⁺ -1.5	-	-	Vcc ⁺ -1.5	V	Vcc ⁺ =30[V]	98
		Full range	-	-	Vcc ⁺ -2.0	-	-	Vcc ⁺ -2.0			
Common-mode Rejection Ratio	CMR	25°C	70	85	-	70	80	-	dB	RS≤10[kΩ]	98
		Full range	60	-	-	60	-	-			
Output Short Circuit Current (*2)	Isource	25°C	20	40	60	20	40	70	mA	Vcc ⁺ =15[V],VO=+2[V] VID=+1[V]	99
Output Sink Current (*2)	Isink	25°C	10	20	-	10	20	-	mA	VO=+2[V], Vcc ⁺ =15[V],VID=-1[V]	99
			12	50	-	12	50	-	μA	VO=+0.2[V], Vcc ⁺ =15[V],VID=-1[V]	
Output Voltage Swing	Vopp	25°C	0	-	Vcc ⁺ -1.5	-	-	-	V	RL=2[kΩ]	99
		Full range	0	-	Vcc ⁺ -2.0	-	-	-			
High Level Output Voltage	VOH	25°C	27	28	-	27	28	-	V	Vcc ⁺ =30[V],RL=10[kΩ]	99
		Full range	27	-	-	27	-	-			
Low Level Output Voltage	VOL	25°C	-	5	20	-	5	20	mV	RL=10[kΩ]	99
		Full range	-	-	20	-	-	20			
Slew Rate	SR	25°C	-	0.6	-	-	0.4	-	V/μs	RL=2[kΩ],CL=100[pF], Vcc ⁺ =15[V] VI=0.5[V] to 3[V], Unity Gain	99
Gain Bandwidth Product	GBP	25°C	-	1.1	-	-	1.3	-	MHz	Vcc ⁺ =30[V],RL=2[kΩ], CL=100[pF] VIN=10[mV],f=100[kHz]	99
Total Harmonic Distortion	THD	25°C	-	0.02	-	-	0.015	-	%	f=1[kHz],AV=20[dB] RL=2[kΩ] CL=100[pF],VO=2[Vpp]	99
Input Equivalent Noise Voltage	en	25°C	-	55	-	-	40	-	nV/√Hz	f=1[kHz],RS=100[Ω] Vcc ⁺ =30[V]	99
Input Offset Voltage Drift	DVIO	-	-	7	-	-	7	-	μV/°C	-	-
Input Offset Current Drift	DIIO	-	-	10	-	-	10	-	pA/°C	-	-
Channel Separation	VO1/VO2	25°C	-	120	-	-	120	-	dB	1[kHz]≤f≤20[kHz]	99

(*1) Absolute value

(*2) Under high temperatures, please consider the power dissipation when selecting the output current.

When output terminal is continuously shorted the output current reduces the internal temperature by flushing.

OLM2904,LM2902 family(Unless otherwise specified, Vcc+=+5[V], Vcc-=0[V])

Parameter	Symbol	Temperature range	Limit						Unit	Conditions	Fig. No
			LM2904 family			LM2902 family					
			Min.	Typ.	Max.	Min.	Typ.	Max.			
Input Offset Voltage (*3)	VIO	25°C	—	2	7	—	2	7	mV	VO=1.4[V]	98
		Full range	—	—	9	—	—	9			
Input Offset Current (*3)	IIO	25°C	—	2	50	—	2	30	nA	VO=1.4[V]	98
		Full range	—	—	200	—	—	200			
Input Bias Current (*3)	IIB	25°C	—	20	150	—	20	150	nA	VO=1.4[V]	98
		Full range	—	—	200	—	—	300			
Large Signal Voltage Gain	AVD	25°C	25	100	—	25	100	—	V/mV	Vcc+=15[V] VO=1.4[V] to 11.4[V] RL=2[kΩ]	98
Supply Voltage Rejection Ratio	SVR	25°C	65	100	—	65	110	—	dB	RS≤10[kΩ]	99
		Full range	65	—	—	65	—	—			
Supply Current (All Amp)	ICC	25°C	—	0.7	1.2	—	0.7	1.2	mA	Vcc+=5[V],No Lord	99
		25°C	—	—	—	—	1.5	3		Vcc+=30[V],No Lord	
		Full range	—	—	2	—	0.8	1.2		Vcc+=5[V],No Lord	
		Full range	—	—	—	—	1.5	3		Vcc+=30[V],No Lord	
Input Common-mode Voltage Range	VICM	25°C	—	—	Vcc+-1.5	—	—	Vcc+-1.5	V	Vcc+=30[V]	98
		Full range	—	—	Vcc+-2.0	—	—	Vcc+-2.0			
Common-mode Rejection Ratio	CMR	25°C	70	85	—	70	80	—	dB	RS=10[kΩ]	98
		Full range	60	—	—	60	—	—			
Output Short Circuit Current (*4)	Isource	25°C	20	40	60	20	40	70	mA	Vcc+=+15[V],VO=+2[V] VID=+1[V]	98
Output Sink Current (*4)	Isink	25°C	10	20	—	10	20	—	mA	VO=2[V],Vcc+=+5[V] VID=-1[V]	99
			12	50	—	12	50	—	μA	VO=+0.2[V], Vcc+=+15[V],VID=-1[V]	
Output Voltage Swing	Vopp	25°C	0	—	Vcc+-1.5	—	—	—	V	RL=2[kΩ]	99
		Full range	0	—	Vcc+-2.0	—	—	—			
High Level Output Voltage	VOH	25°C	27	—	—	27	28	—	V	Vcc+=30[V],RL=10[kΩ]	99
		Full range	27	28	—	27	—	—		Vcc+=30[V],RL=10[kΩ]	
Low Level Output Voltage	VOL	25°C	—	5	20	—	5	20	mV	RL=10[kΩ]	99
		Full range	—	—	20	—	—	20			
Slew Rate	SR	25°C	—	0.6	—	—	0.4	—	V/μs	RL=2[kΩ],CL=100[pF], Unity Gain VI=0.5[V] to 3[V] Vcc+=1.5[V]	99
Gain Bandwidth Product	GBP	25°C	—	1.1	—	—	1.3	—	MHz	Vcc+=30[V],RL=2[kΩ] CL=100[pF] VIN=10[mV]	99
Total Harmonic Distortion	THD	25°C	—	0.02	—	—	0.015	—	%	f=1[kHz],AV=20[dB] RL=2[kΩ] CL=100[pF], Vcc+=30[V],VO=2[Vpp]	99
Input Equivalent Noise Voltage	en	25°C	—	—	—	—	40	—	nV/√Hz	f=1[kHz],RS=100[Ω] Vcc+=30[V]	99
Input Offset Voltage Drift	DVIO	—	—	7	—	—	7	—	μV/°C	-	—
Input Offset Current Drift	DIIO	—	—	10	—	—	10	—	pA/°C	-	—
Channel Separation	VO1/VO2	25°C	—	120	—	—	120	—	dB	1[kHz]≤f≤20[kHz]	99

(*3) Absolute value

(*4) Under high temperatures, please consider the power dissipation when selecting the output current.

When the output terminal is continuously shorted the output current reduces the internal temperature by flushing.

●Reference Data LM358 family

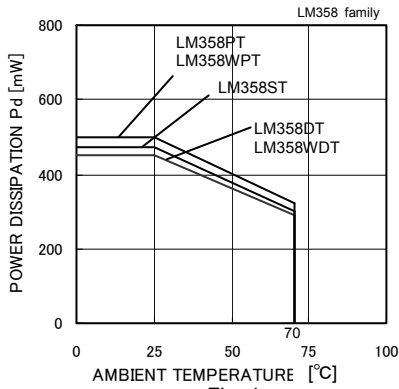

Fig. 1

Derating Curve

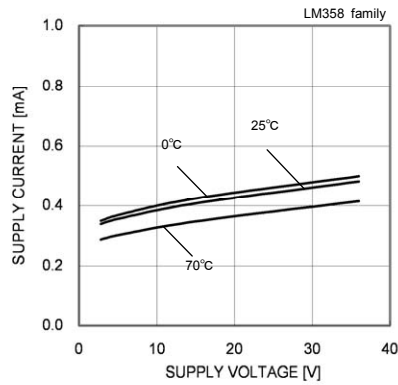

Fig. 2

Supply Current – Supply Voltage

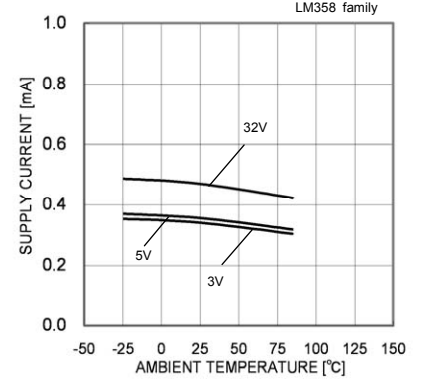

Fig. 3

Supply Current – Ambient Temperature

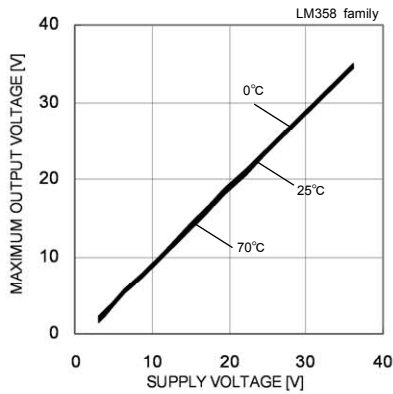

Fig. 4

Maximum Output Voltage – Supply Voltage
($R_L=10[k\Omega]$)

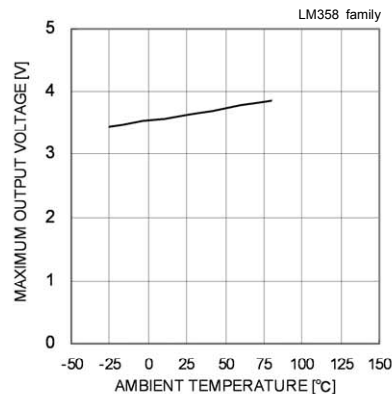

Fig. 5

Maximum Output Voltage – Ambient Temperature
($V_{CC}=5[V]$, $R_L=2[k\Omega]$)

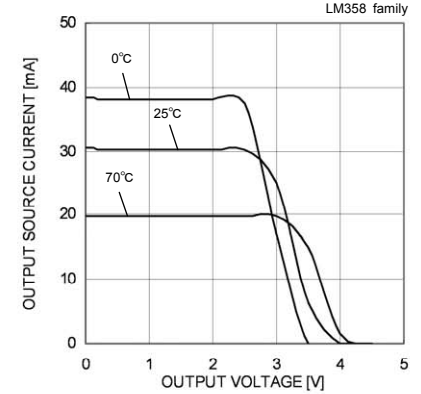

Fig. 6

Output Source Current – Output Voltage
($V_{CC}=5[V]$)

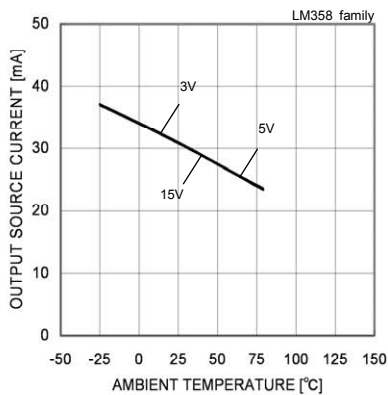

Fig. 7

Output Source Current – Ambient Temperature
($V_{OUT}=0[V]$)

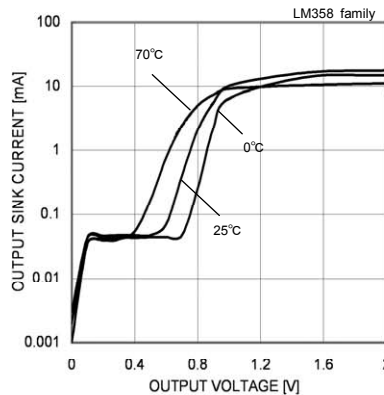

Fig. 8

Output Sink Current – Output Voltage
($V_{CC}=5[V]$)

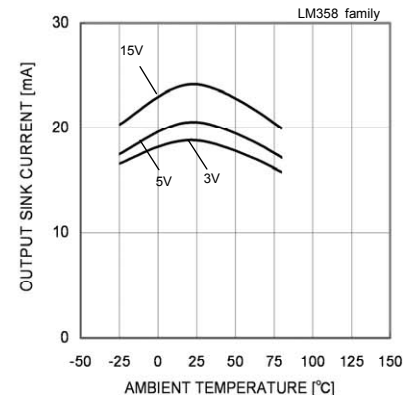

Fig. 9

Output Sink Current – Ambient Temperature
($V_{OUT}=V_{CC}$)

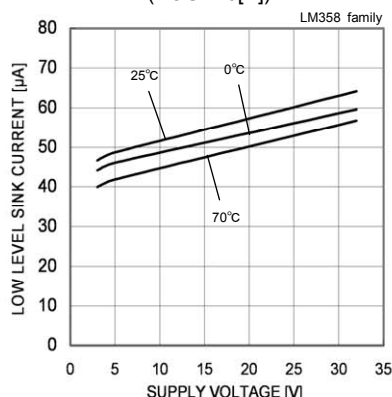

Fig. 10

Low Level Sink Current - Supply Voltage
($V_{OUT}=0.2[V]$)

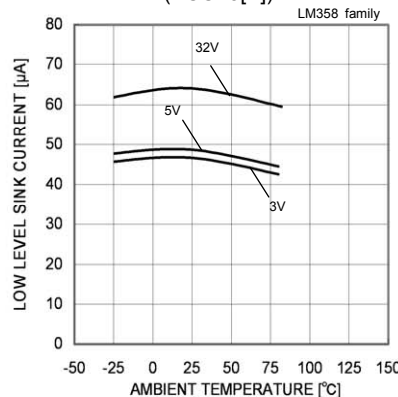

Fig. 11

Low Level Sink Current - Ambient Temperature
($V_{OUT}=0.2[V]$)

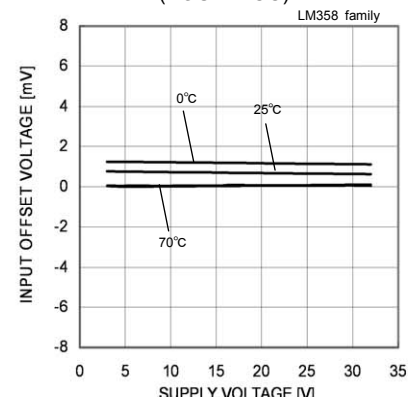

Fig. 12

Input Offset Voltage - Supply Voltage
($V_{icm}=0[V]$, $V_{OUT}=1.4[V]$)

(*)The data above is ability value of sample, it is not guaranteed.

●Reference Data LM358 family

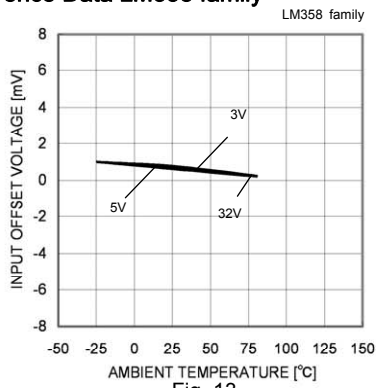

Fig. 13
Input Offset Voltage – Ambient Temperature
(Vicm=0[V], VOUT=1.4[V])

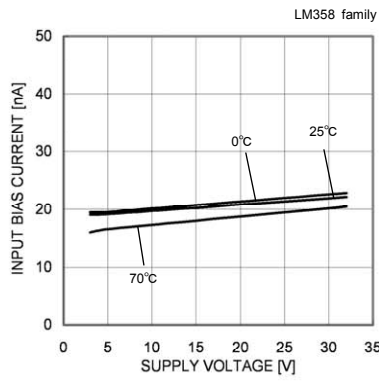

Fig. 14
Input Bias Current – Supply Voltage
(Vicm=0[V], VOUT=1.4[V])

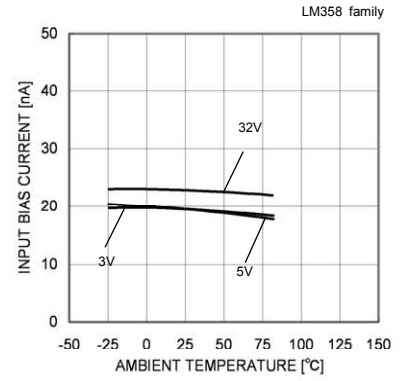

Fig. 15
Input Bias Current – Ambient Temperature
(Vicm=0[V], VOUT=1.4[V])

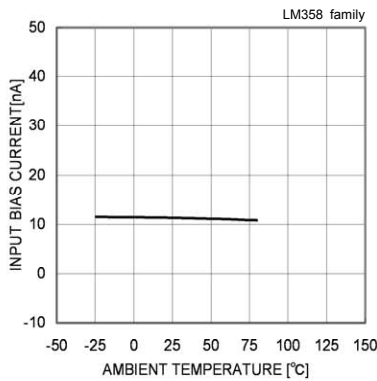

Fig. 16
Input Bias Current – Ambient Temperature
(VCC=30[V], Vicm=28[V], VOUT=1.4[V])

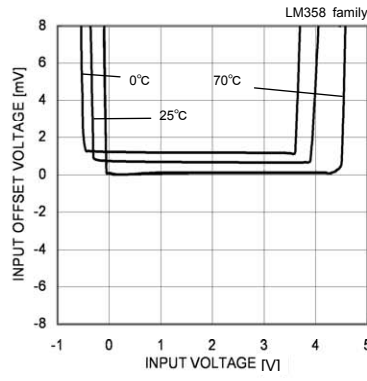

Fig. 17
Input Offset Voltage – Common Mode Input Voltage
(VCC=5[V])

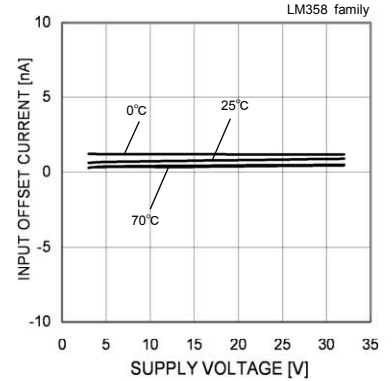

Fig. 18
Input Offset Current – Supply Voltage
(Vicm=0[V], VOUT=1.4[V])

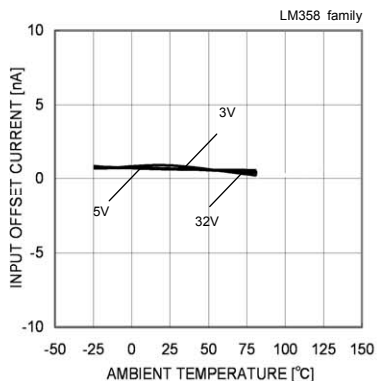

Fig. 19
Input Offset Current – Ambient Temperature
(Vicm=0[V], VOUT=1.4[V])

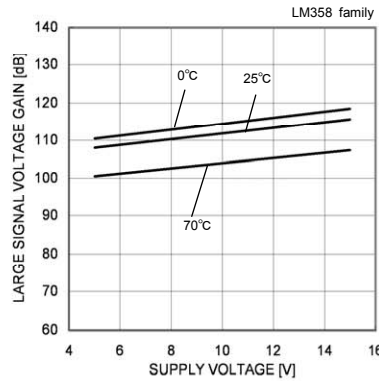

Fig. 20
Large Signal Voltage Gain – Supply Voltage
(RL=2[kΩ])

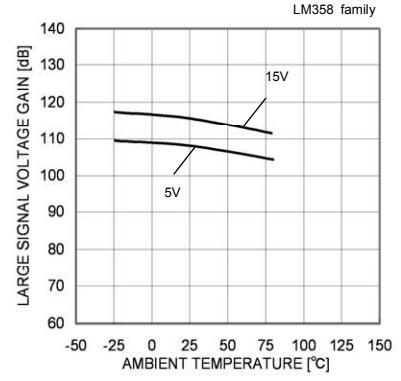

Fig. 21
Large Signal Voltage Gain – Ambient Temperature
(RL=2[kΩ])

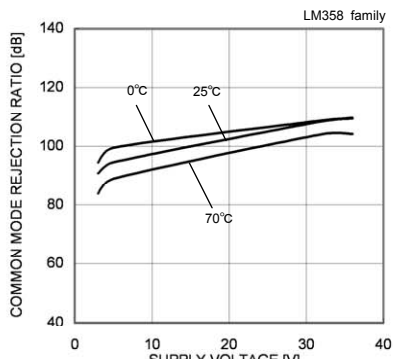

Fig. 22
Common Mode Rejection Ratio – Supply Voltage

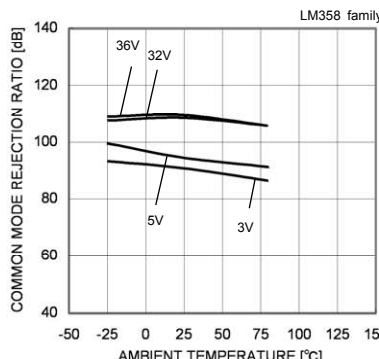

Fig. 23
Common Mode Rejection Ratio – Ambient Temperature

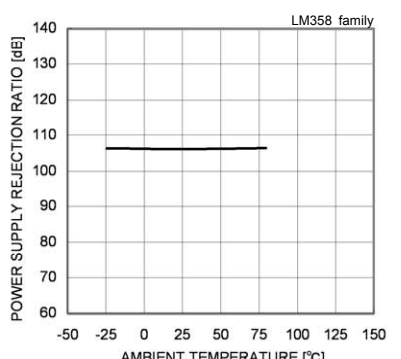

Fig. 24
Power Supply Rejection Ratio – Ambient Temperature

(*)The data above is ability value of sample, it is not guaranteed.

●Reference Data LM324 family

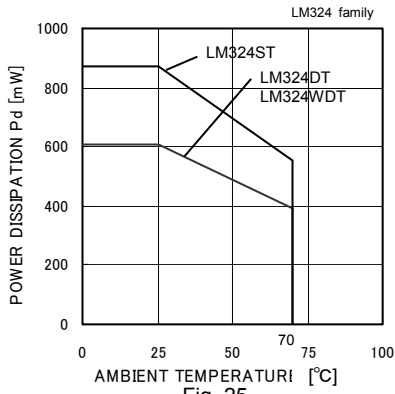

Fig. 25
Derating Curve

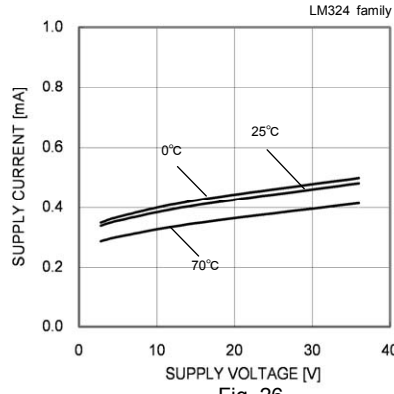

Fig. 26
Supply Current - Supply Voltage

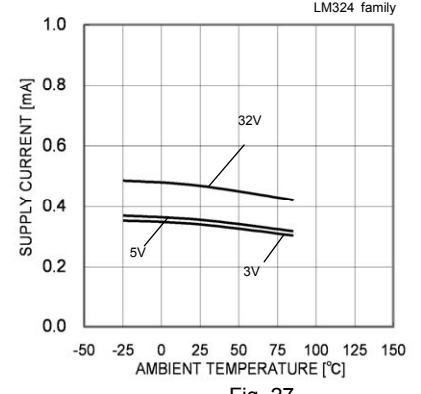

Fig. 27
Supply Current - Ambient Temperature

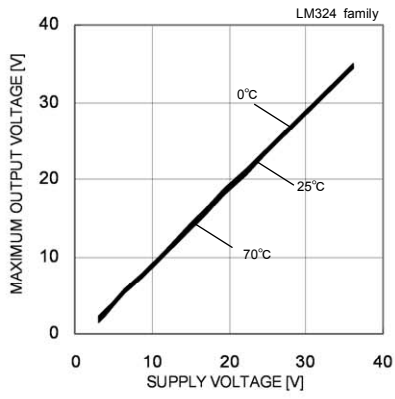

Fig. 28
Maximum Output Voltage - Supply Voltage
($R_L=10[k\Omega]$)

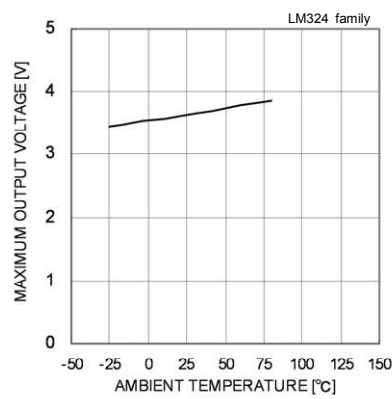

Fig. 29
Maximum Output Voltage - Ambient Temperature
($V_{CC}=5[V], R_L=2[k\Omega]$)

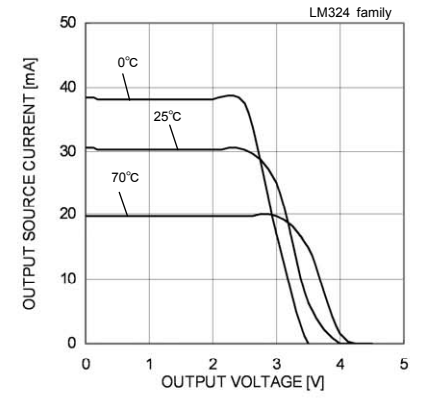

Fig. 30
Output Source Current - Output Voltage
($V_{CC}=5[V]$)

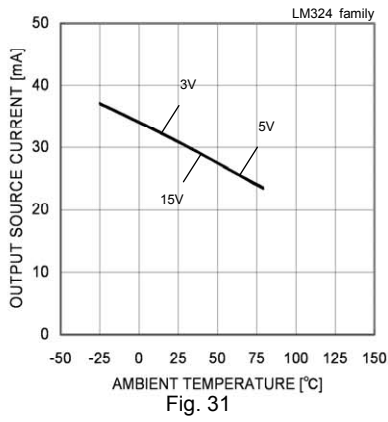

Fig. 31
Output Source Current - Ambient Temperature
($V_{OUT}=0[V]$)

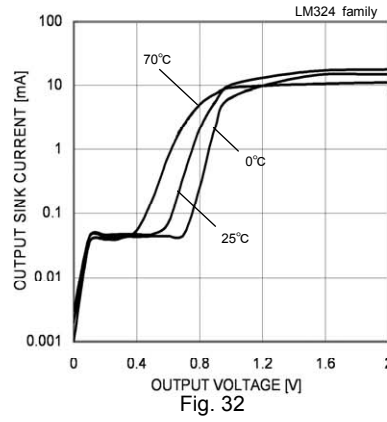

Fig. 32
Output Sink Current - Output Voltage
($V_{CC}=5[V]$)

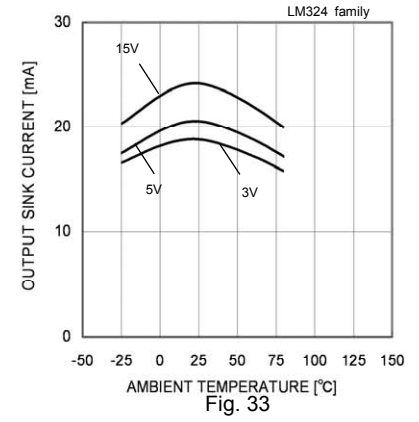

Fig. 33
Output Sink Current - Ambient Temperature
($V_{OUT}=V_{CC}$)

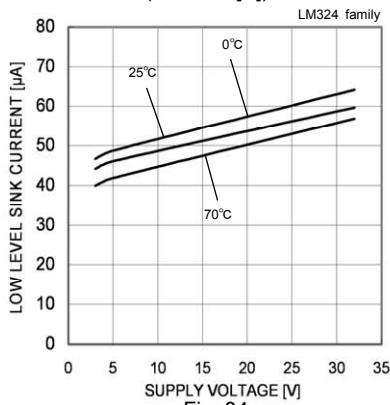

Fig. 34
Low Level Sink Current - Supply Voltage
($V_{OUT}=0.2[V]$)

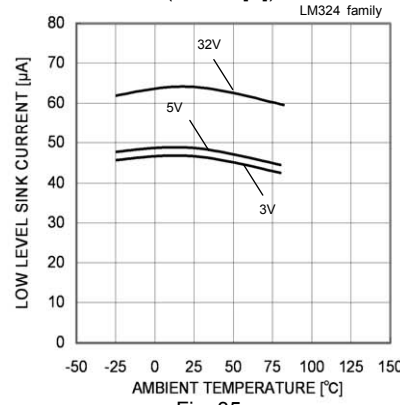

Fig. 35
Low Level Sink Current - Ambient Temperature
($V_{OUT}=0.2[V]$)

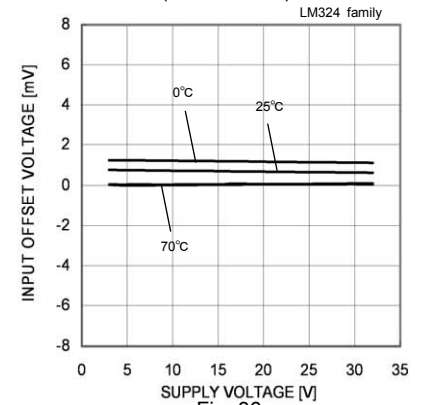

Fig. 36
Input Offset Voltage - Supply Voltage
($V_{icm}=0[V], V_{OUT}=1.4[V]$)

(*)The data above is ability value of sample, it is not guaranteed.

●Reference Data LM324 family

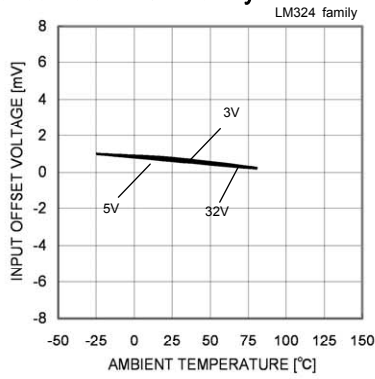

Fig. 37

Input Offset Voltage – Ambient Temperature
($V_{icm}=0[V]$, $V_{OUT}=1.4[V]$)

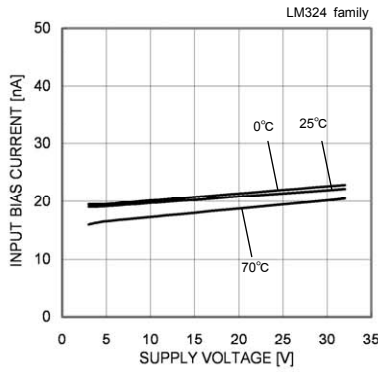

Fig. 38

Input Bias Current – Supply Voltage
($V_{icm}=0[V]$, $V_{OUT}=1.4[V]$)

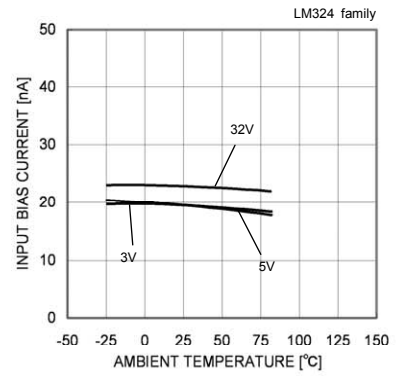

Fig. 39

Input Bias Current – Ambient Temperature
($V_{icm}=0[V]$, $V_{OUT}=1.4[V]$)

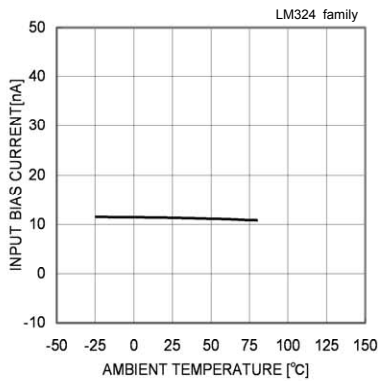

Fig. 40

Input Bias Current – Ambient Temperature
($V_{CC}=30[V]$, $V_{icm}=28[V]$, $V_{OUT}=1.4[V]$)

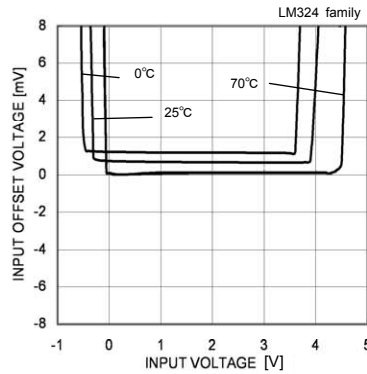

Fig. 41

Input Offset Voltage – Common Mode Input Voltage
($V_{CC}=5[V]$)

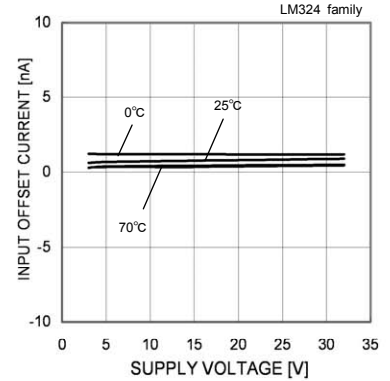

Fig. 42

Input Offset Current – Supply Voltage
($V_{icm}=0[V]$, $V_{OUT}=1.4[V]$)

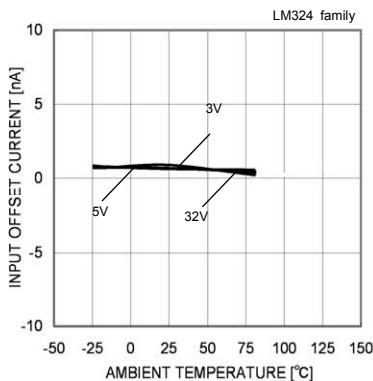

Fig. 43

Input Offset Current – Ambient Temperature
($V_{icm}=0[V]$, $V_{OUT}=1.4[V]$)

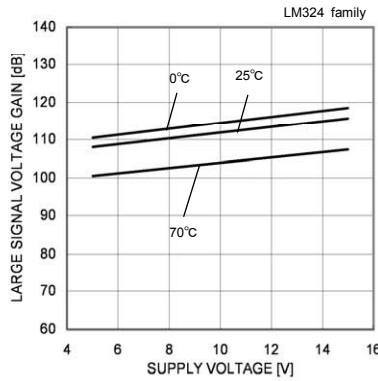

Fig. 44

Large Signal Voltage Gain – Supply Voltage
($R_L=2[k\Omega]$)

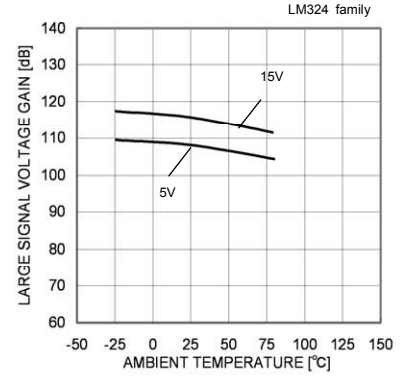

Fig. 45

Large Signal Voltage Gain – Ambient Temperature
($R_L=2[k\Omega]$)

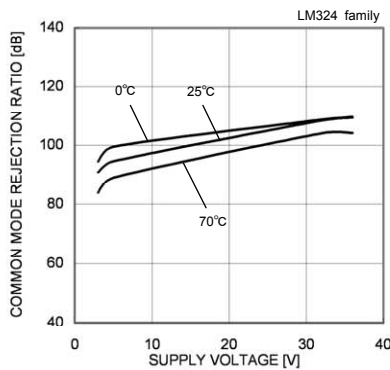

Fig. 46

Common Mode Rejection Ratio – Supply Voltage

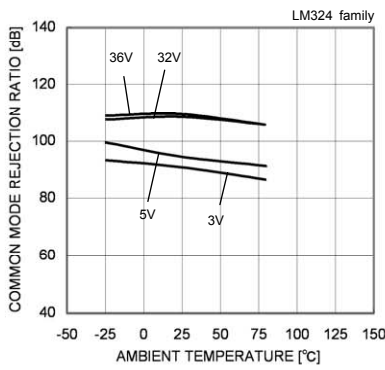

Fig. 47

Common Mode Rejection Ratio – Ambient Temperature

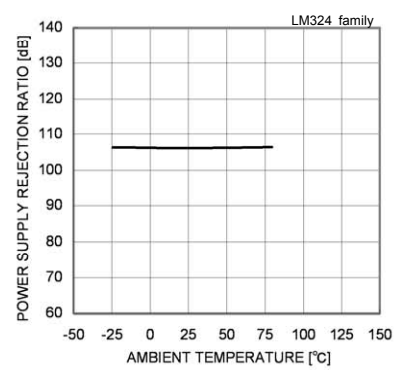

Fig. 48

Power Supply Rejection Ratio – Ambient Temperature

(*)The data above is ability value of sample, it is not guaranteed.

●Reference Data LM2904 family

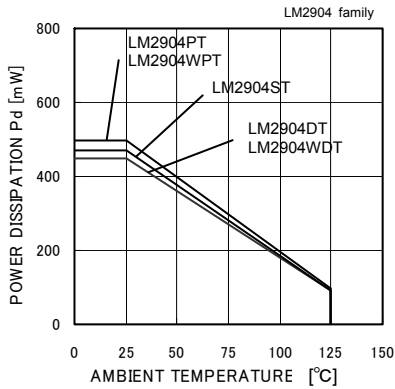

Fig. 49
Derating Curve

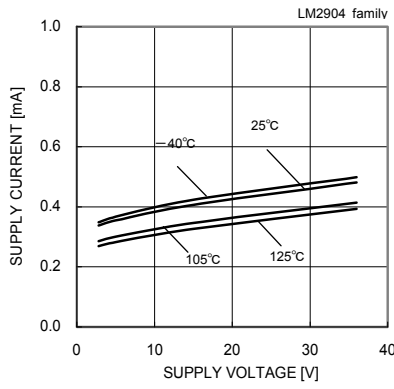

Fig. 50
Supply Current - Supply Voltage

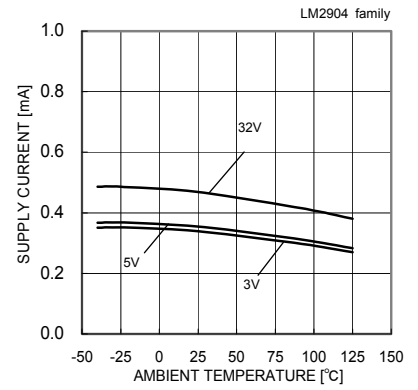

Fig. 51
Supply Current - Ambient Temperature

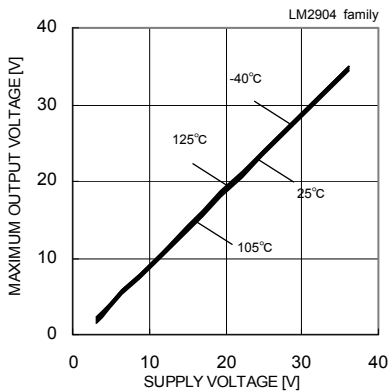

Fig. 52
Maximum Output Voltage - Supply Voltage
(RL=10[kΩ])

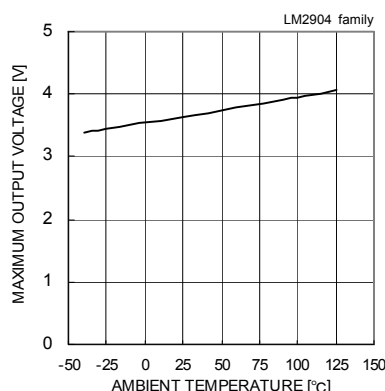

Fig. 53
Maximum Output Voltage - Ambient Temperature
(VCC=5[V], RL=2[kΩ])

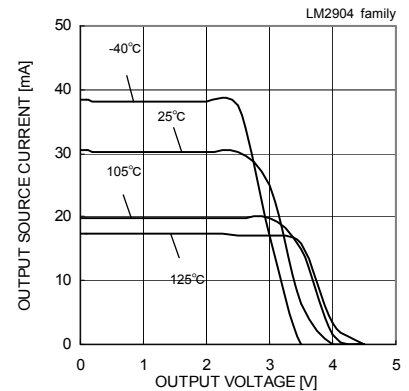

Fig. 54
Output Source Current - Output Voltage
(VCC=5[V])

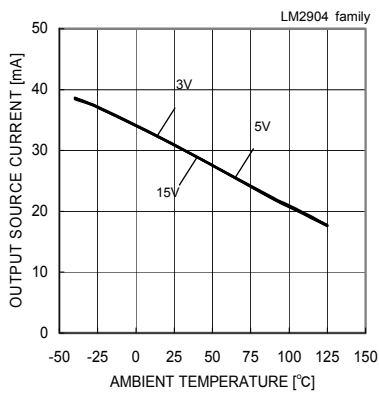

Fig. 55
Output Source Current - Ambient Temperature
(VOUT=0[V])

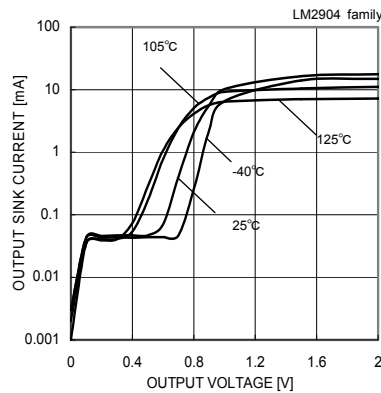

Fig. 56
Output Sink Current - Output Voltage
(VCC=5[V])

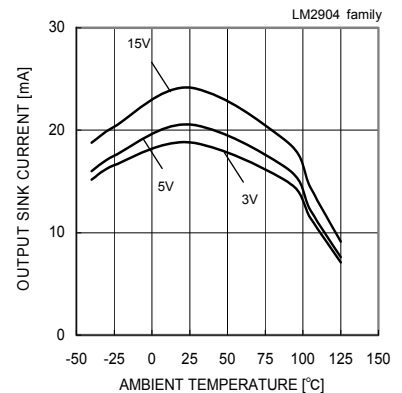

Fig. 57
Output Sink Current - Ambient Temperature
(VOUT=VCC)

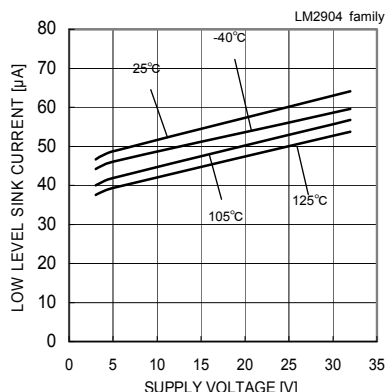

Fig. 58
Low Level Sink Current - Supply Voltage
(VOUT=0.2[V])

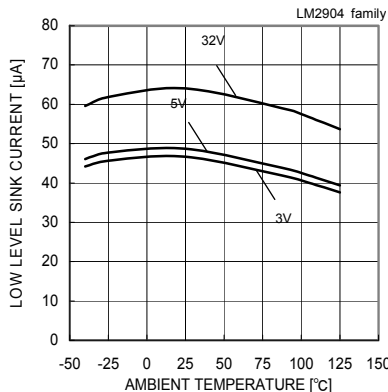

Fig. 59
Low Level Sink Current - Ambient Temperature
(VOUT=0.2[V])

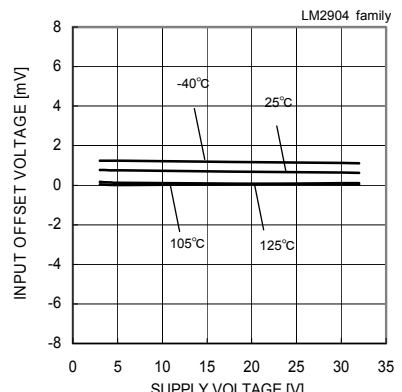

Fig. 60
Input Offset Voltage - Supply Voltage
(Vicm=0[V], VOUT=1.4[V])

(*)The data above is ability value of sample, it is not guaranteed.

●Reference Data LM2904 family

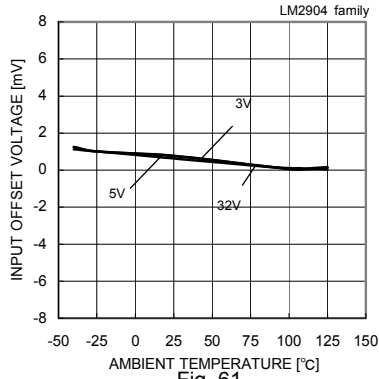

Fig. 61
Input Offset Voltage – Ambient Temperature
(Vicm=0[V], VOUT=1.4[V])

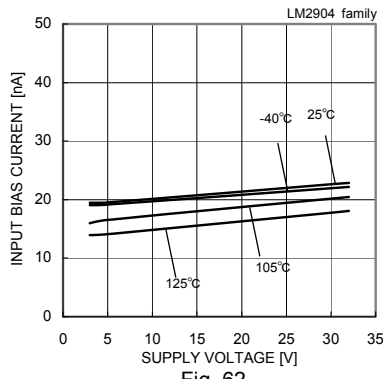

Fig. 62
Input Bias Current – Supply Voltage
(Vicm=0[V], VOUT=1.4[V])

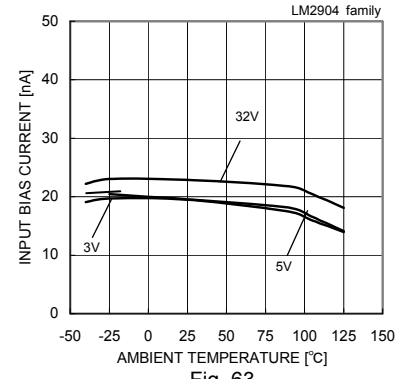

Fig. 63
Input Bias Current – Ambient Temperature
(Vicm=0[V], VOUT=1.4[V])

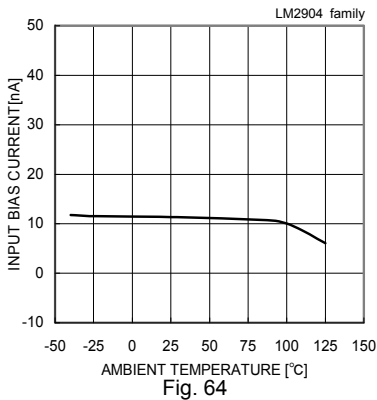

Fig. 64
Input Bias Current – Ambient Temperature
(VCC=30[V], Vicm=28[V], VOUT=1.4[V])

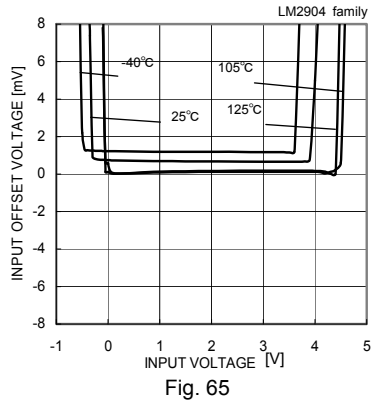

Fig. 65
Input Offset Voltage – Common Mode Input Voltage
(VCC=5[V])

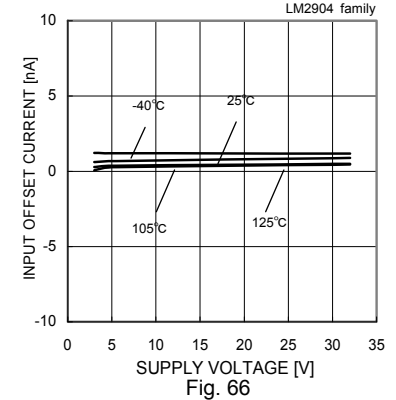

Fig. 66
Input Offset Current – Supply Voltage
(Vicm=0[V], VOUT=1.4[V])

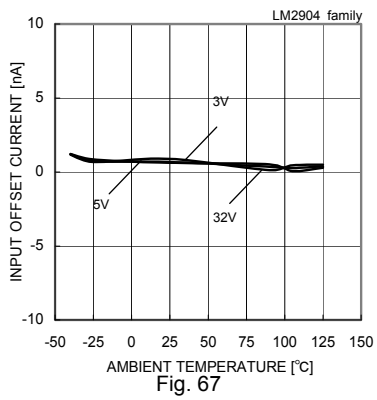

Fig. 67
Input Offset Current – Ambient Temperature
(Vicm=0[V], VOUT=1.4[V])

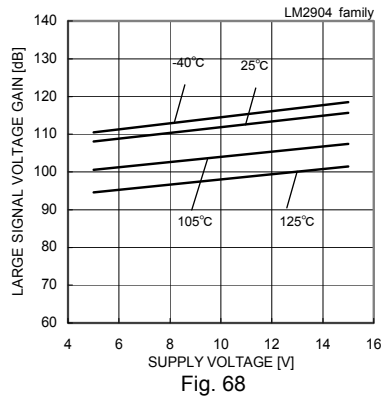

Fig. 68
Large Signal Voltage Gain – Supply Voltage
(RL=2[kΩ])

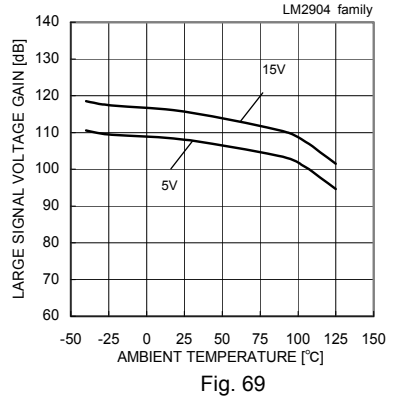

Fig. 69
Large Signal Voltage Gain – Ambient Temperature
(RL=2[kΩ])

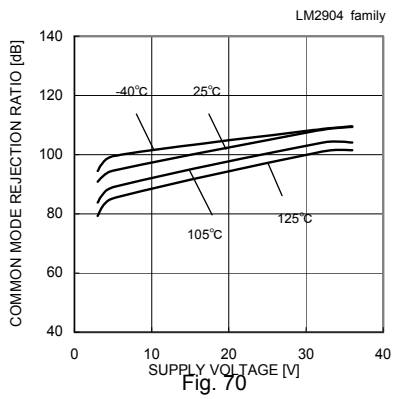

Fig. 70
Common Mode Rejection Ratio – Supply Voltage

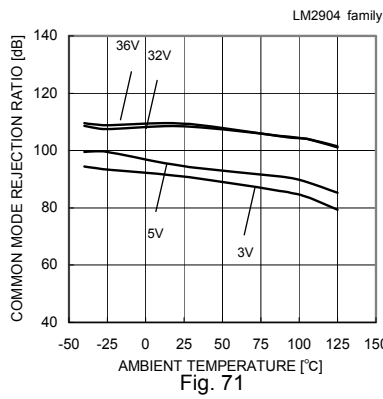

Fig. 71
Common Mode Rejection Ratio – Ambient Temperature

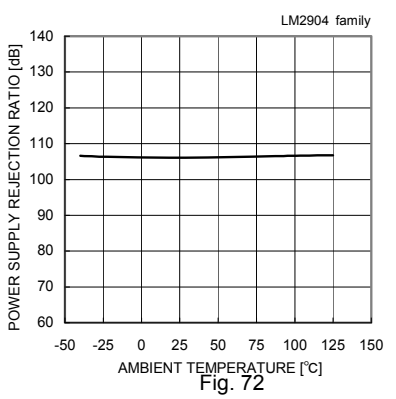

Fig. 72
Power Supply Rejection Ratio – Ambient Temperature

(*)The data above is ability value of sample, it is not guaranteed.

●Reference Data LM2902 family

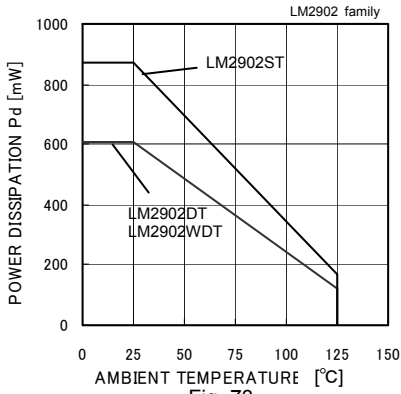

Fig. 73
Derating Curve

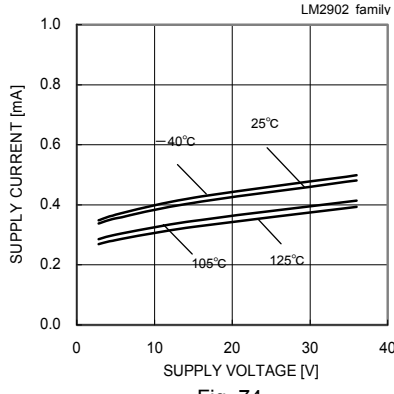

Fig. 74
Supply Current - Supply Voltage

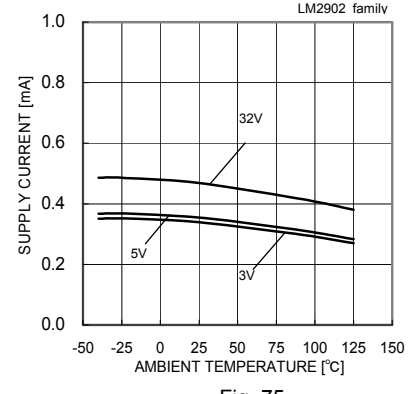

Fig. 75
Supply Current - Ambient Temperature

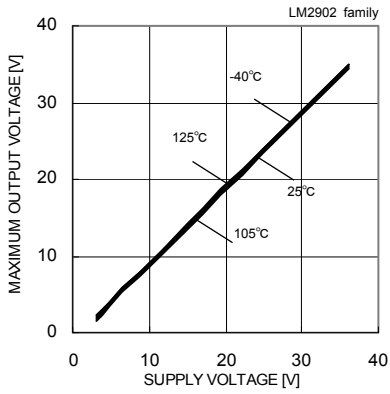

Fig. 76
Maximum Output Voltage - Supply Voltage
(RL=10[kΩ])

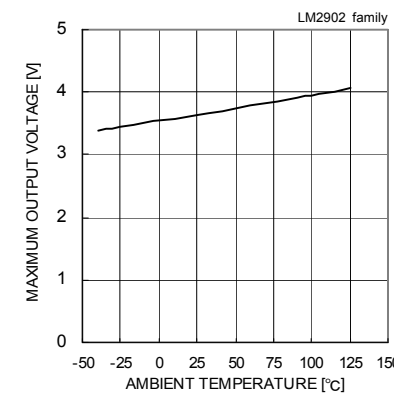

Fig. 77
Maximum Output Voltage - Ambient Temperature
(VCC=5[V], RL=2[kΩ])

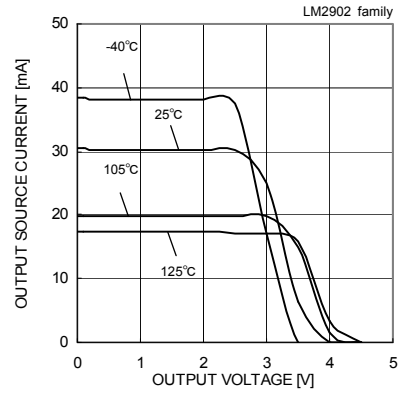

Fig. 78
Output Source Current - Output Voltage
(VCC=5[V])

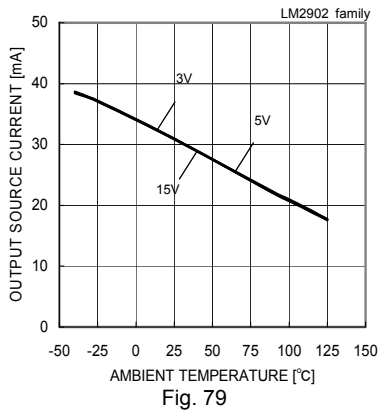

Fig. 79
Output Source Current - Ambient Temperature
(VOUT=0[V])

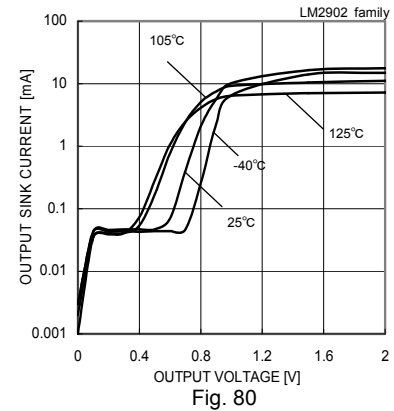

Fig. 80
Output Sink Current - Output Voltage
(VCC=5[V])

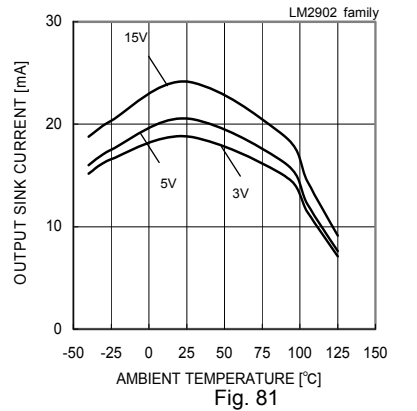

Fig. 81
Output Sink Current - Ambient Temperature
(VOUT=VCC)

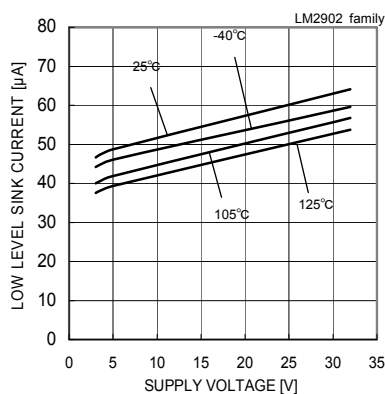

Fig. 82
Low Level Sink Current - Supply Voltage
(VOUT=0.2[V])

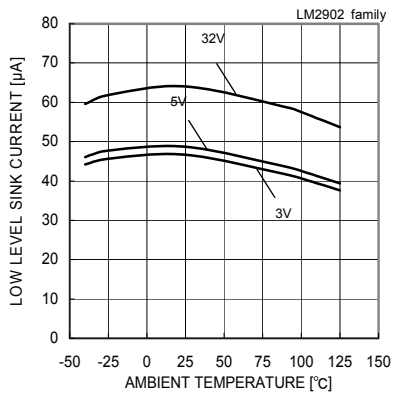

Fig. 83
Low Level Sink Current - Ambient Temperature
(VOUT=0.2[V])

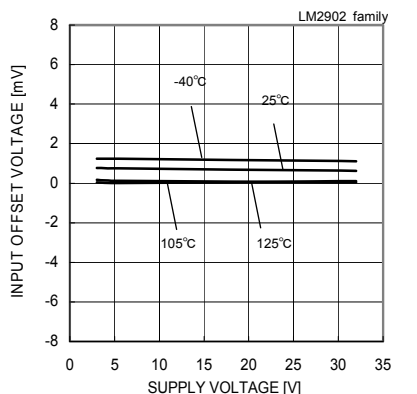

Fig. 84
Input Offset Voltage - Supply Voltage
(Vicm=0[V], VOUT=1.4[V])

(*)The data above is ability value of sample, it is not guaranteed.

●Reference Data LM2902 family

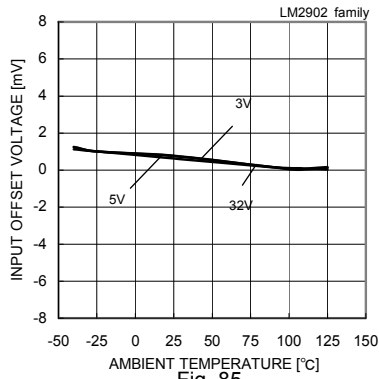

Fig. 85
Input Offset Voltage – Ambient Temperature
(Vicm=0[V], VOUT=1.4[V])

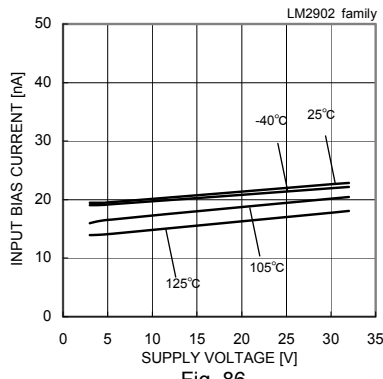

Fig. 86
Input Bias Current – Supply Voltage
(Vicm=0[V], VOUT=1.4[V])

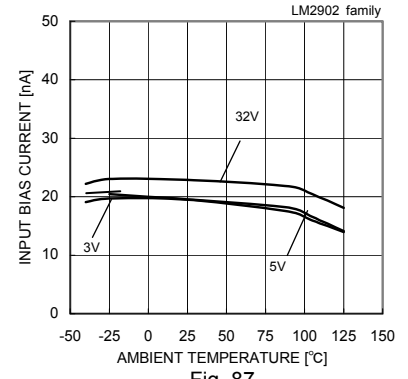

Fig. 87
Input Bias Current – Ambient Temperature
(Vicm=0[V], VOUT=1.4[V])

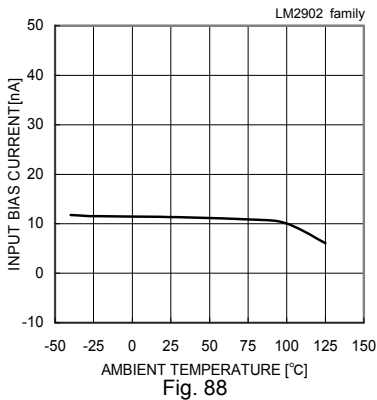

Fig. 88
Input Bias Current – Ambient Temperature
(VCC=30[V], Vicm=28[V], VOUT=1.4[V])

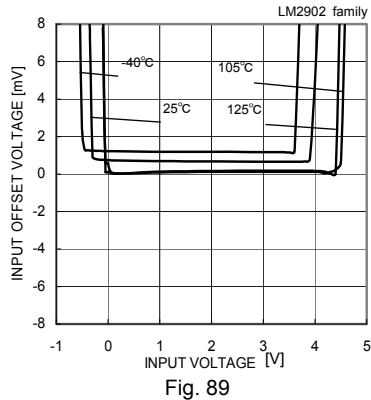

Fig. 89
Input Offset Voltage – Common Mode Input Voltage
(VCC=5[V])

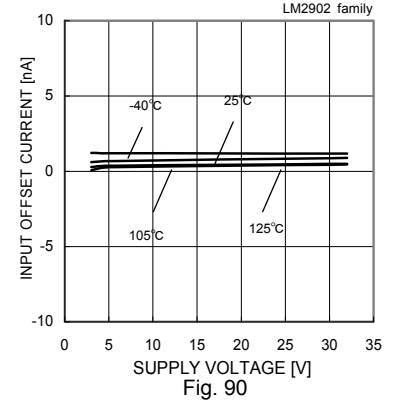

Fig. 90
Input Offset Current – Supply Voltage
(Vicm=0[V], VOUT=1.4[V])

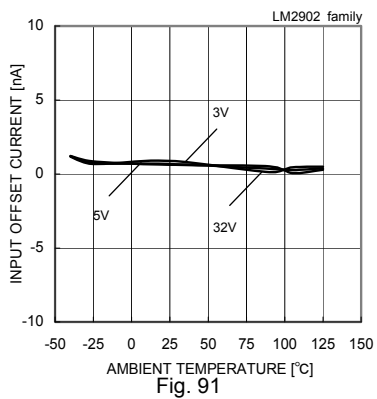

Fig. 91
Input Offset Current – Ambient Temperature
(Vicm=0[V], VOUT=1.4[V])

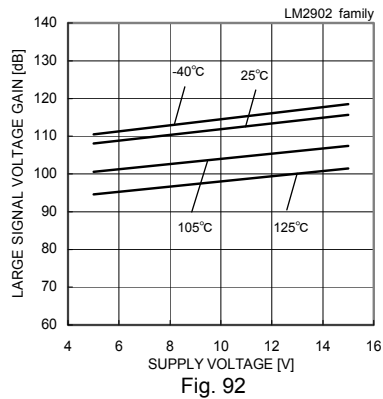

Fig. 92
Large Signal Voltage Gain – Supply Voltage
(RL=2[kΩ])

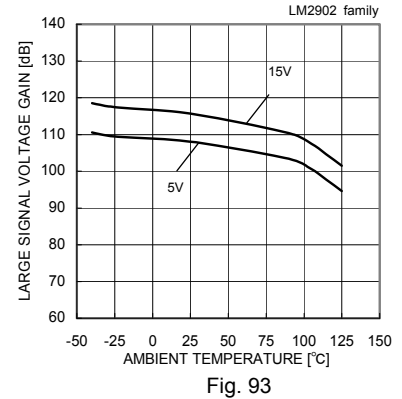

Fig. 93
Large Signal Voltage Gain – Ambient Temperature
(RL=2[kΩ])

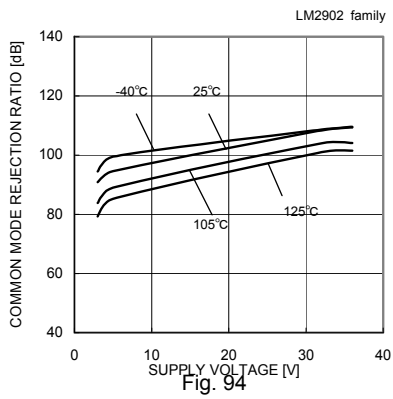

Fig. 94
Common Mode Rejection Ratio – Supply Voltage

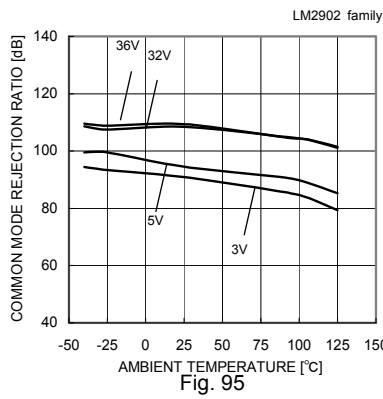

Fig. 95
Common Mode Rejection Ratio – Ambient Temperature

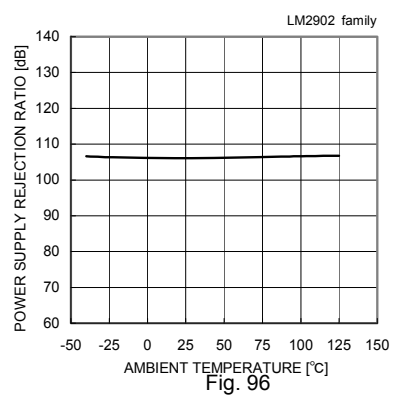

Fig. 96
Power Supply Rejection Ratio – Ambient Temperature

(*)The data above is ability value of sample, it is not guaranteed.

● Circuit Diagram

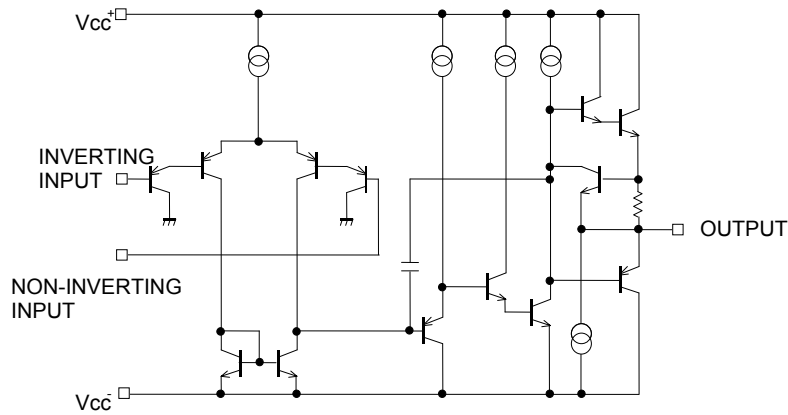

Fig.97 Circuit Diagram (each Op-Amp)

● Measurement Circuit 1 NULL Method Measurement Condition

Vcc+, Vcc-, EK, Vicm Unit: [V]

Parameter	VF	S1	S2	S3	LM358/LM324 family				LM2904/LM2902 family				Calculation
					Vcc+	Vcc-	EK	Vicm	Vcc+	Vcc-	EK	Vicm	
Input Offset Voltage	VF1	ON	ON	OFF	5 to 30	0	-1.4	0	5 to 30	0	-1.4	0	1
Input Offset Current	VF2	OFF	OFF	OFF	5	0	-1.4	0	5	0	-1.4	0	2
Input Bias Current	VF3	OFF	ON	OFF	5	0	-1.4	0	5	0	-1.4	0	3
	VF4	ON	OFF		5	0	-1.4	0	5	0	-1.4	0	
Large Signal Voltage Gain	VF5	ON	ON	ON	15	0	-1.4	0	15	0	-1.4	0	4
	VF6				15	0	-11.4	0	15	0	-11.4	0	
Common-mode Rejection Ratio	VF7	ON	ON	OFF	5	0	-1.4	0	5	0	-1.4	0	5
	VF8				5	0	-1.4	3.5	5	0	-1.4	3.5	
Supply Voltage Rejection Ratio	VF9	ON	ON	OFF	5	0	-1.4	0	5	0	-1.4	0	6
	VF10				30	0	-1.4	0	30	0	-1.4	0	

— Calculation —

1. Input Offset Voltage (VIO)

$$V_{io} = \frac{1}{1 + R_f/R_s} [V]$$

2. Input Offset Current (IIO)

$$I_{io} = \frac{1}{R_i} \frac{V_{F2} - V_{F4}}{1 + R_f/R_s} [A]$$

3. Input Bias Current (IIB)

$$I_b = \frac{|V_{F4} - V_{F3}|}{2 \times R_i (1 + R_f/R_s)} [A]$$

4. Large Signal Voltage Gain (AVD)

$$AV = 20 \times \log \frac{10 \times (1 + R_f/R_s)}{|V_{F6} - V_{F5}|} [dB]$$

5. Common-mode Rejection Ratio (CMRR)

$$CMRR = 20 \times \log \frac{3.5 \times (1 + R_f/R_s)}{|V_{F8} - V_{F7}|} [dB]$$

6. Supply Voltage Rejection Ratio (SVR)

$$PSRR = 20 \times \log \frac{\Delta V_{cc+} \times (1 + R_f/R_s)}{V_{F10} - V_{F9}} [dB]$$

$\Delta V_{cc+} = 25V$

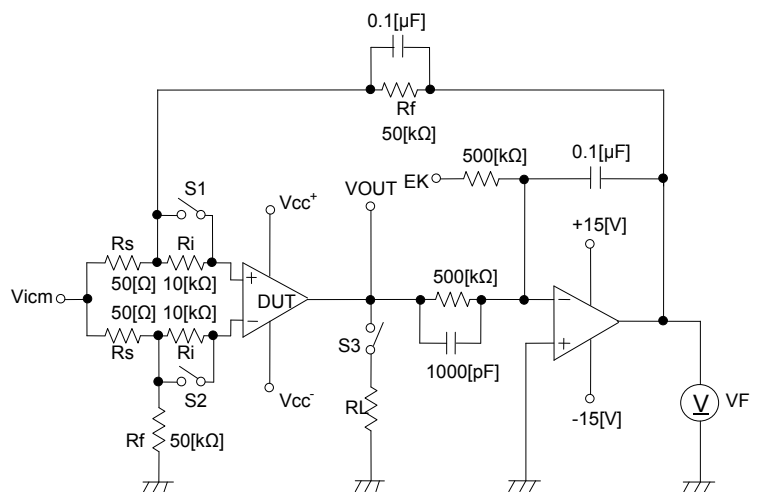

Fig.98 Measurement circuit1 (Each Op-Amps)

● Measurement circuit2 Switch condition

SW No.	SW 1	SW 2	SW 3	SW 4	SW 5	SW 6	SW 7	SW 8	SW 9	SW 10	SW 11	SW 12	SW 13	SW 14	SW 15
Supply Current	OFF	OFF	OFF	ON	OFF	OFF	ON	OFF	OFF	OFF	OFF	OFF	OFF	OFF	OFF
High level Output Voltage	OFF	OFF	ON	OFF	OFF	OFF	ON	OFF	OFF	ON	OFF	OFF	OFF	ON	OFF
Low level Output Voltage	OFF	OFF	ON	OFF	OFF	OFF	ON	OFF	OFF	OFF	OFF	OFF	OFF	ON	OFF
Output source current	OFF	OFF	ON	OFF	OFF	OFF	ON	OFF	OFF	OFF	OFF	OFF	OFF	OFF	ON
Output sink current	OFF	OFF	ON	OFF	OFF	OFF	ON	OFF	OFF	OFF	OFF	OFF	OFF	OFF	ON
Slew Rate	OFF	OFF	OFF	ON	OFF	OFF	OFF	OFF	ON	ON	ON	OFF	OFF	OFF	OFF
Gain band width product	OFF	ON	OFF	OFF	OFF	ON	ON	OFF	OFF	ON	ON	OFF	OFF	OFF	OFF
Equivalent input noise voltage	ON	OFF	OFF	OFF	ON	OFF	ON	OFF	OFF	OFF	OFF	ON	OFF	OFF	OFF

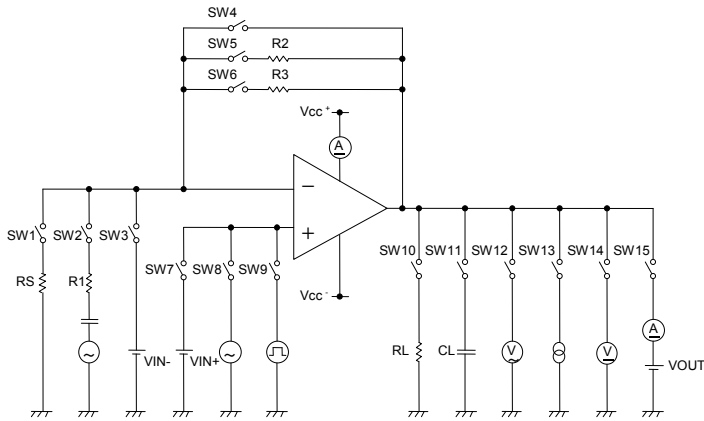

Fig.99 Measurement circuit2 (Each Op-Amps)

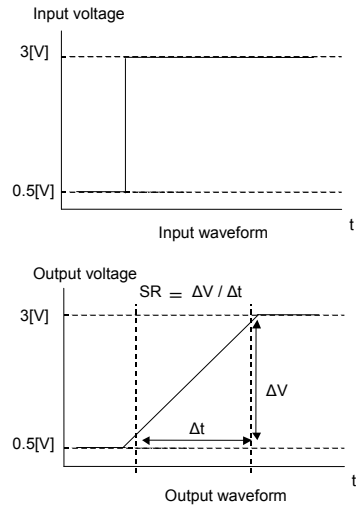

Fig.100 Slew Rate Input Waveform

● Measurement Circuit3 Channel Separation

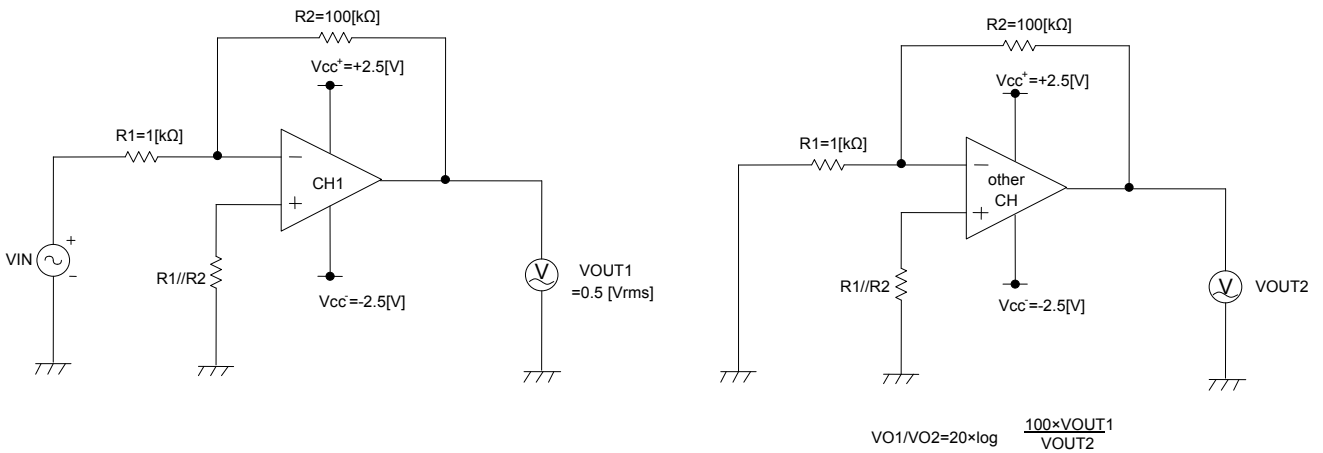

Fig.101 Measurement Circuit3

● Description of Electrical Characteristics

Described below are descriptions of the relevant electrical terms

Please note that item names, symbols and their meanings may differ from those on another manufacturer's documents.

1. Absolute maximum ratings

The absolute maximum ratings are values that should never be exceeded, since doing so may result in deterioration of electrical characteristics or damage to the part itself as well as peripheral components.

1.1 Power supply voltage (V_{CC}^+ / V_{CC}^-)

Expresses the maximum voltage that can be supplied between the positive and negative supply terminals without causing deterioration of the electrical characteristics or destruction of the internal circuitry.

1.2 Differential input voltage (VID)

Indicates the maximum voltage that can be supplied between the non-inverting and inverting terminals without damaging the IC.

1.3 Input common-mode voltage range (VICM)

Signifies the maximum voltage that can be supplied to non-inverting and inverting terminals without causing deterioration of the characteristics or damage to the IC itself. Normal operation is not guaranteed within the common-mode voltage range of the maximum ratings – use within the input common-mode voltage range of the electric characteristics instead.

1.4 Operating and storage temperature ranges (T_{opr} , T_{stg})

The operating temperature range indicates the temperature range within which the IC can operate. The higher the ambient temperature, the lower the power consumption of the IC. The storage temperature range denotes the range of temperatures the IC can be stored under without causing excessive deterioration of the electrical characteristics.

1.5 Power dissipation (Pd)

Indicates the power that can be consumed by a particular mounted board at ambient temperature (25°C). For packaged products, Pd is determined by the maximum junction temperature and the thermal resistance.

2. Electrical characteristics

2.1 Input offset voltage (VIO)

Signifies the voltage difference between the non-inverting and inverting terminals. It can be thought of as the input voltage difference required for setting the output voltage to 0 V.

2.2 Input offset voltage drift (DVIO)

Denotes the ratio of the input offset voltage fluctuation to the ambient temperature fluctuation.

2.3 Input offset current (IIO)

Indicates the difference of input bias current between the non-inverting and inverting terminals.

2.4 Input offset current drift (DIIO)

Signifies the ratio of the input offset current fluctuation to the ambient temperature fluctuation.

2.5 Input bias current (IIB)

Denotes the current that flows into or out of the input terminal, it is defined by the average of the input bias current at the non-inverting terminal and the input bias current at the inverting terminal.

2.6 Circuit current (ICC)

Indicates the current of the IC itself that flows under specified conditions and during no-load steady state.

2.7 High level output voltage/low level output voltage (VOH/VOL)

Signifying the voltage range that can be output under specified load conditions, it is in general divided into high level output voltage and low level output voltage. High level output voltage indicates the upper limit of the output voltage, while low level output voltage the lower limit.

2.8 Large signal voltage gain (AVD)

The amplifying rate (gain) of the output voltage against the voltage difference between non-inverting and inverting terminals, it is (normally) the amplifying rate (gain) with respect to DC voltage.

$AVD = (\text{output voltage fluctuation}) / (\text{input offset fluctuation})$

2.9 Input common-mode voltage range (VICM)

Indicates the input voltage range under which the IC operates normally.

2.10 Common-mode rejection ratio (CMRR)

Signifies the ratio of fluctuation of the input offset voltage when the in-phase input voltage is changed (DC fluctuation).

$CMRR = (\text{change in input common-mode voltage}) / (\text{input offset fluctuation})$

2.11 Power supply rejection ratio (SVR)

Denotes the ratio of fluctuation of the input offset voltage when supply voltage is changed (DC fluctuation).

$SVR = (\text{change in power supply voltage}) / (\text{input offset fluctuation})$

2.12 Output source current/ output sink current (IOH/IOL)

The maximum current that can be output under specific output conditions, it is divided into output source current and output sink current. The output source current indicates the current flowing out of the IC, and the output sink current the current flowing into the IC.

2.13 Channel separation (VO1/VO2)

Expresses the amount of fluctuation of the input offset voltage or output voltage with respect to the change in the output voltage of a driven channel.

2.14 Slew rate (SR)

Indicates the time fluctuation ratio of the output voltage when an input step signal is supplied.

2.15 Gain bandwidth product (GBP)

The product of the specified signal frequency and the gain of the op-amp at such frequency, it gives the approximate value of the frequency where the gain of the op-amp is 1 (maximum frequency, and unity gain frequency).

● Derating curves

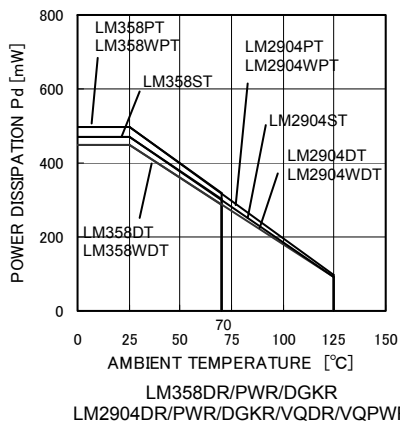

Power Dissipation		
Package	Pd[W]	θ_{ja} [°C/W]
SO package8 (*8)	450	3.6
TSSOP8 (*6)	500	4.0
Mini SO8 (*7)	470	3.76

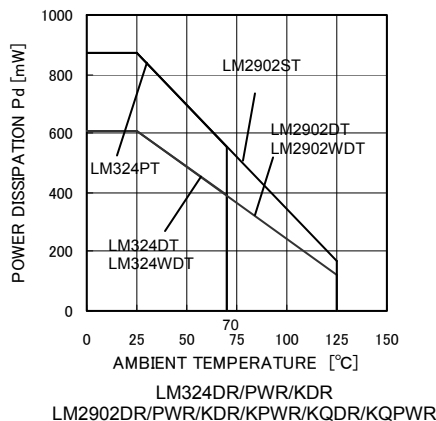

Power Dissipation		
Package	Pd[W]	θ_{ja} [°C/W]
SO package14	610	4.9
TSSOP14	870	7.0

Fig.102 Derating Curves

● Precautions

- 1) Unused circuits
When there are unused circuits, it is recommended that they be connected as in Fig.103, setting the non-inverting input terminal to a potential within the in-phase input voltage range (VICM).
- 2) Input terminal voltage
Applying $V_{cc} + 32V$ to the input terminal is possible without causing deterioration of the electrical characteristics or destruction, irrespective of the supply voltage. However, this does not ensure normal circuit operation. Please note that the circuit operates normally only when the input voltage is within the common mode input voltage range of the electric characteristics.
- 3) Power supply (single / dual)
The op-amp operates when the voltage supplied is between V_{cc}^+ and V_{cc}^- . Therefore, the single supply op-mp can be used as a dual supply op-amp as well.
- 4) Power dissipation (Pd)
Using the unit in excess of the rated power dissipation may cause deterioration in electrical characteristics due to the rise in chip temperature, including reduced current capability. Therefore, please take into consideration the power dissipation (Pd) under actual operating conditions and apply a sufficient margin in thermal design. Refer to the thermal derating curves for more information.
- 5) Short-circuit between pins and erroneous mounting
Incorrect mounting may damage the IC. In addition, the presence of foreign substances between the outputs, the output and the power supply, or the output and V_{cc}^- may result in IC destruction.
- 6) Operation in a strong electromagnetic field
Operation in a strong electromagnetic field may cause malfunctions.
- 7) Radiation
This IC is not designed to withstand radiation.
- 8) IC handling
Applying mechanical stress to the IC by deflecting or bending the board may cause fluctuation of the electrical characteristics due to piezoelectric (piezo) effects.
- 9) IC operation
The output stage of the IC is configured using Class C push-pull circuits. Therefore, when the load resistor is connected to the middle potential of V_{cc}^+ and V_{cc}^- , crossover distortion occurs at the changeover between discharging and charging of the output current. Connecting a resistor between the output terminal and V_{cc}^- , and increasing the bias current for Class A operation will suppress crossover distortion.
- 10) Board inspection
Connecting a capacitor to a pin with low impedance may stress the IC. Therefore, discharging the capacitor after every process is recommended. In addition, when attaching and detaching the jig during the inspection phase, ensure that the power is turned OFF before inspection and removal. Furthermore, please take measures against ESD in the assembly process as well as during transportation and storage.
- 11) Output capacitor
Discharge of the external output capacitor to V_{cc}^+ is possible via internal parasitic elements when V_{cc}^+ is shorted to V_{cc}^- , causing damage to the internal circuitry due to thermal stress. Therefore, when using this IC in circuits where oscillation due to output capacitive load does not occur, such as in voltage comparators, use an output capacitor with a capacitance less than 0.1 μ F.

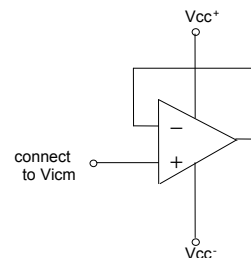

Fig.103 Disable circuit example

●Ordering part number

L	M	2	9	0	2
---	---	---	---	---	---

W

D

T

Family name

LM358
LM324
LM2902
LM2904

ESD Tolerance applicable

W : 2kV
None : Normal

Package type

D : S.O package
P : TSSOP
S : Mini SO

Packaging and forming specification

R: Embossed tape and reel

S.O package8

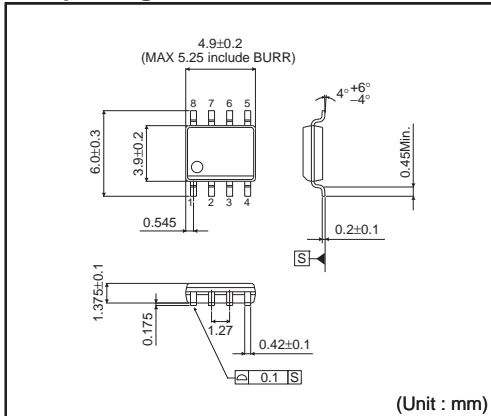

(Unit : mm)

<Tape and Reel information>

Tape	Embossed carrier tape
Quantity	2500pcs
Direction of feed	(The direction is the 1pin of product is at the upper left when you hold reel on the left hand and you pull out the tape on the right hand)

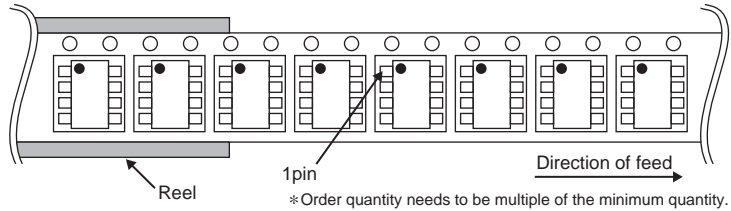

S.O package14

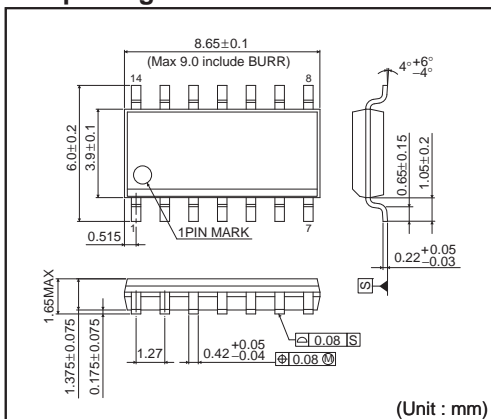

(Unit : mm)

<Tape and Reel information>

Tape	Embossed carrier tape
Quantity	2500pcs
Direction of feed	(The direction is the 1pin of product is at the upper left when you hold reel on the left hand and you pull out the tape on the right hand)

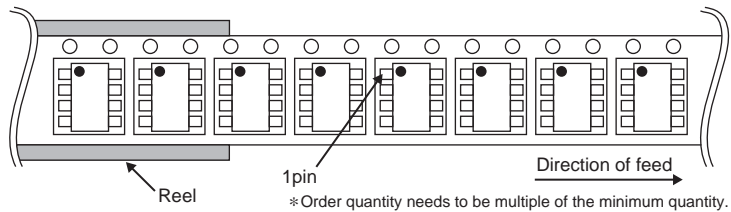

TSSOP8

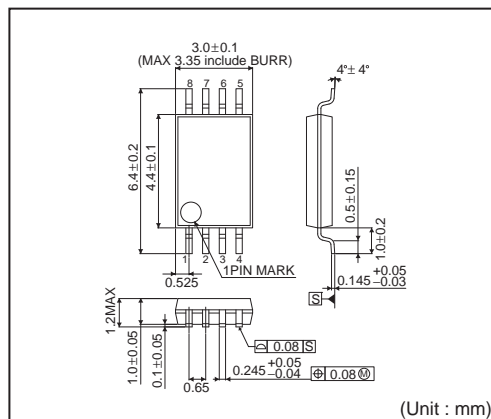

(Unit : mm)

<Tape and Reel information>

Tape	Embossed carrier tape
Quantity	2500pcs
Direction of feed	(The direction is the 1pin of product is at the upper left when you hold reel on the left hand and you pull out the tape on the right hand)

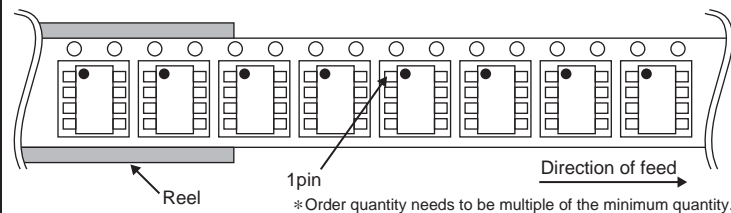

TSSOP14

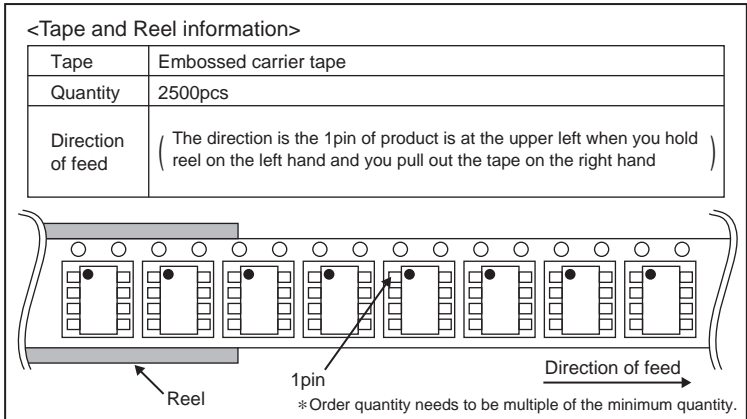
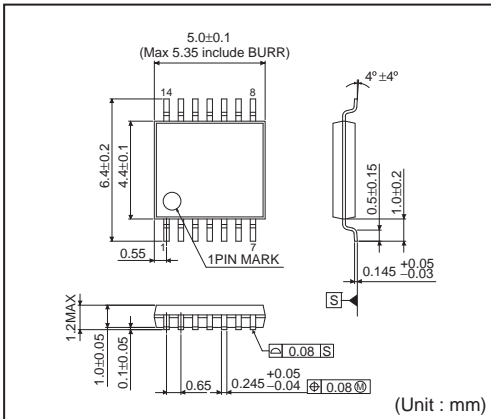

Mini SO8

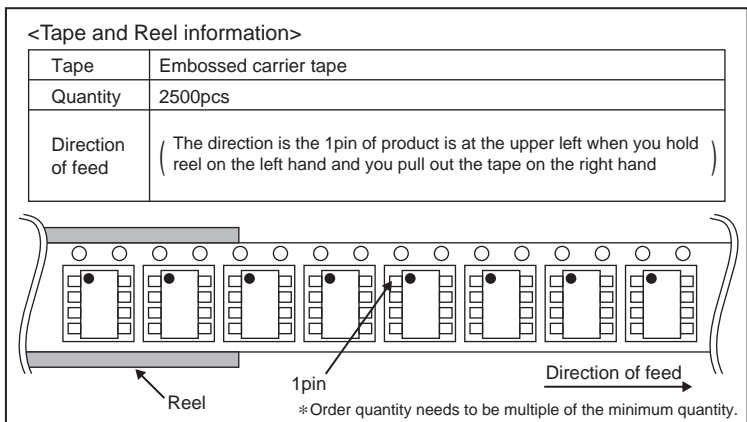
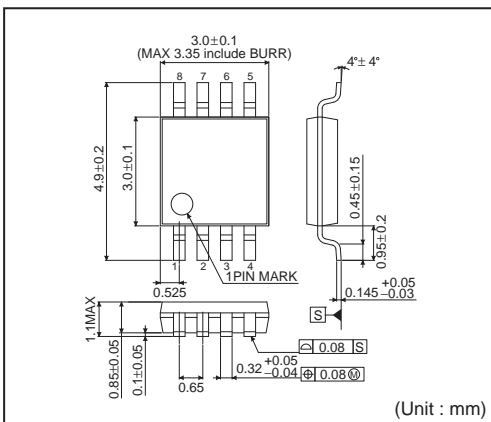

Notes

No copying or reproduction of this document, in part or in whole, is permitted without the consent of ROHM Co.,Ltd.

The content specified herein is subject to change for improvement without notice.

The content specified herein is for the purpose of introducing ROHM's products (hereinafter "Products"). If you wish to use any such Product, please be sure to refer to the specifications, which can be obtained from ROHM upon request.

Examples of application circuits, circuit constants and any other information contained herein illustrate the standard usage and operations of the Products. The peripheral conditions must be taken into account when designing circuits for mass production.

Great care was taken in ensuring the accuracy of the information specified in this document. However, should you incur any damage arising from any inaccuracy or misprint of such information, ROHM shall bear no responsibility for such damage.

The technical information specified herein is intended only to show the typical functions of and examples of application circuits for the Products. ROHM does not grant you, explicitly or implicitly, any license to use or exercise intellectual property or other rights held by ROHM and other parties. ROHM shall bear no responsibility whatsoever for any dispute arising from the use of such technical information.

The Products specified in this document are intended to be used with general-use electronic equipment or devices (such as audio visual equipment, office-automation equipment, communication devices, electronic appliances and amusement devices).

The Products specified in this document are not designed to be radiation tolerant.

While ROHM always makes efforts to enhance the quality and reliability of its Products, a Product may fail or malfunction for a variety of reasons.

Please be sure to implement in your equipment using the Products safety measures to guard against the possibility of physical injury, fire or any other damage caused in the event of the failure of any Product, such as derating, redundancy, fire control and fail-safe designs. ROHM shall bear no responsibility whatsoever for your use of any Product outside of the prescribed scope or not in accordance with the instruction manual.

The Products are not designed or manufactured to be used with any equipment, device or system which requires an extremely high level of reliability the failure or malfunction of which may result in a direct threat to human life or create a risk of human injury (such as a medical instrument, transportation equipment, aerospace machinery, nuclear-reactor controller, fuel-controller or other safety device). ROHM shall bear no responsibility in any way for use of any of the Products for the above special purposes. If a Product is intended to be used for any such special purpose, please contact a ROHM sales representative before purchasing.

If you intend to export or ship overseas any Product or technology specified herein that may be controlled under the Foreign Exchange and the Foreign Trade Law, you will be required to obtain a license or permit under the Law.



Thank you for your accessing to ROHM product informations.
More detail product informations and catalogs are available, please contact us.

ROHM Customer Support System

<http://www.rohm.com/contact/>