

1 AMP HIGH RELIABILITY SILICON DIODES

FEATURES

- PROPRIETARY **SOFT GLASS®** JUNCTION PASSIVATION FOR SUPERIOR RELIABILITY AND PERFORMANCE
- VOID FREE VACUUM DIE SOLDERING FOR MAXIMUM MECHANICAL STRENGTH AND HEAT DISSIPATION (Solder Voids: Typical $\leq 2\%$, Max. $\leq 10\%$ of Die Area)
- EXTREMELY LOW LEAKAGE AT HIGH TEMPERATURES
- LOW FORWARD VOLTAGE DROP
- 1A at $T_A = 75^\circ\text{C}$ WITH NO THERMAL RUNAWAY

MECHANICAL DATA

- Case: JEDEC DO-41, molded epoxy (U/L Flammability Rating 94V-0)
- Terminals: Plated axial leads
- Soldering: Per MIL-STD 202 Method 208 guaranteed
- Polarity: Color band denotes cathode
- Mounting Position: Any
- Weight: 0.012 Ounces (0.34 Grams)

RoHS COMPLIANT

MECHANICAL SPECIFICATION

ACTUAL SIZE OF DO-41 PACKAGE

SERIES GP100 - GP110

DO - 41

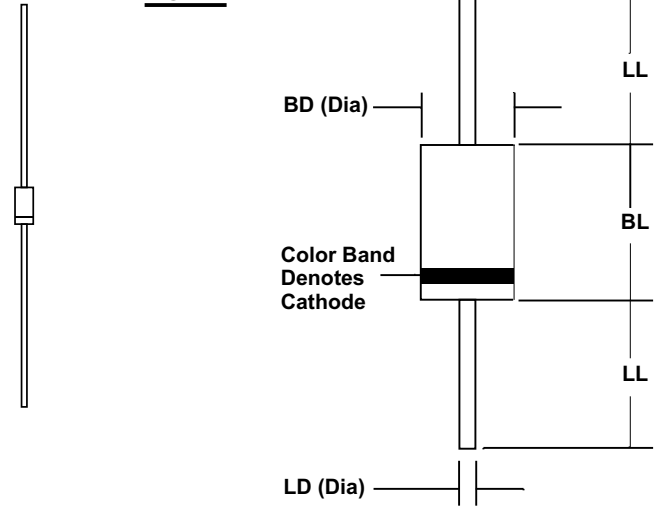

Sym	Minimum		Maximum	
	In	mm	In	mm
BL	0.160	4.1	0.205	5.2
BD	0.103	2.6	0.107	2.7
LL	1.00	25.4		
LD	0.028	0.71	0.034	0.86

MAXIMUM RATINGS & ELECTRICAL CHARACTERISTICS

Ratings at 25 °C ambient temperature unless otherwise specified.
 Single phase, half wave, 60Hz, resistive or inductive load.
 For capacitive loads, derate current by 20%.

PARAMETER (TEST CONDITIONS)	SYMBOL	RATINGS							UNITS
		GP100	GP101	GP102	GP104	GP106	GP108	GP110	
Series Number									
Maximum DC Blocking Voltage	V_{RM}	50	100	200	400	600	800	1000	VOLTS
Maximum RMS Voltage	V_{RMS}	35	70	140	280	420	560	700	
Maximum Peak Recurrent Reverse Voltage	V_{RRM}	50	100	200	400	600	800	1000	
Average Forward Rectified Current @ $T_A = 75^\circ\text{C}$, Lead length = 0.375 in. (9.5 mm)	I_o	1							AMPS
Peak Forward Surge Current (8.3 mSec single half sine wave superimposed on rated load)	I_{FSM}	50							
Maximum Forward Voltage at 1 Amp DC	V_{FM}	1							VOLTS
Maximum Full Cycle Reverse Current @ $T_L = 75^\circ\text{C}$ (Note 1)	$I_{RM(AV)}$	5							μA
Maximum Average DC Reverse Current @ $T_A = 25^\circ\text{C}$ At Rated DC Blocking Voltage @ $T_A = 125^\circ\text{C}$	I_{RM}	0.5 30.0							
Typical Thermal Resistance, Junction to Ambient (Note 1)	$R_{\theta JA}$	30							
Typical Junction Capacitance (Note 2)	C_J	10							pF
Operating and Storage Temperature Range	T_J, T_{STG}	-65 to +175							$^\circ\text{C}$

NOTES: (1) Lead length = 0.375 in. (9.5 mm)
 (2) Measured at 1MHz & applied reverse voltage of 4 volts

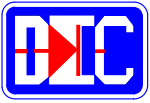

1 AMP HIGH RELIABILITY SILICON DIODES

RATING & CHARACTERISTIC CURVES FOR SERIES GP100 - GP110

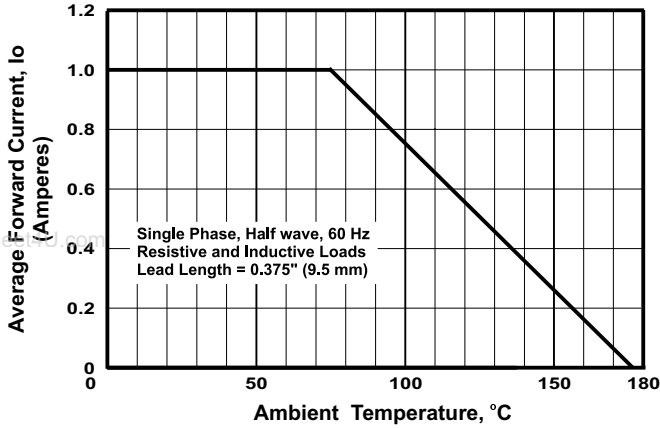

FIGURE 1. FORWARD CURRENT DERATING CURVE

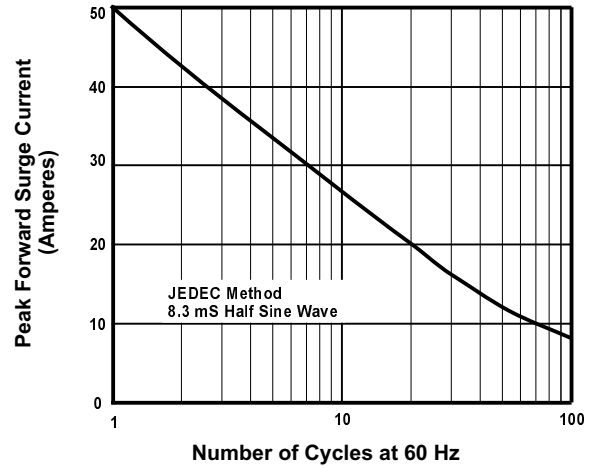

FIGURE 2. MAXIMUM NON-REPETITIVE SURGE CURRENT

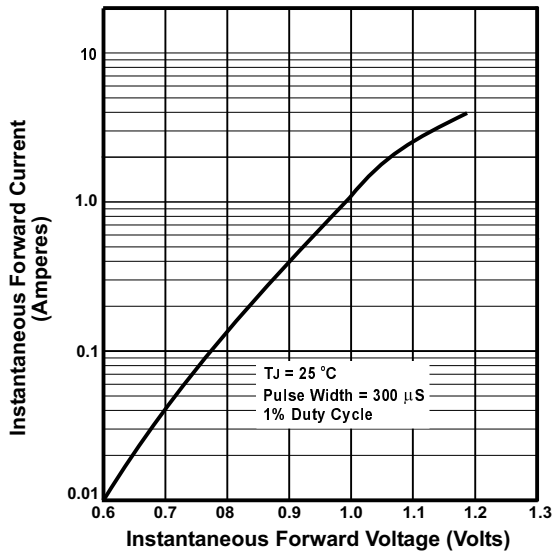

FIGURE 3. TYPICAL FORWARD CHARACTERISTIC PER DIODE

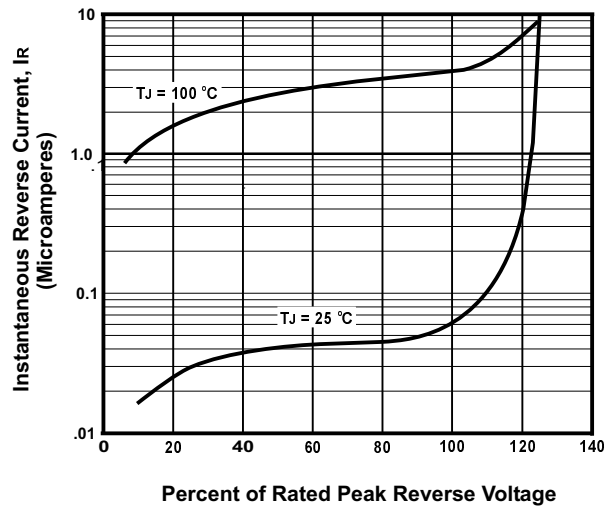

FIGURE 4. TYPICAL REVERSE CHARACTERISTICS

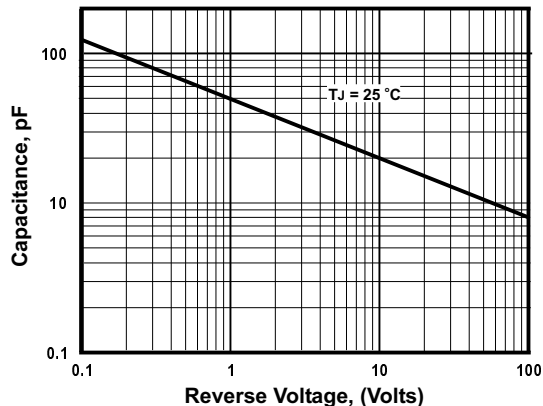

FIGURE 5. TYPICAL JUNCTION CAPACITANCE PER DIODE

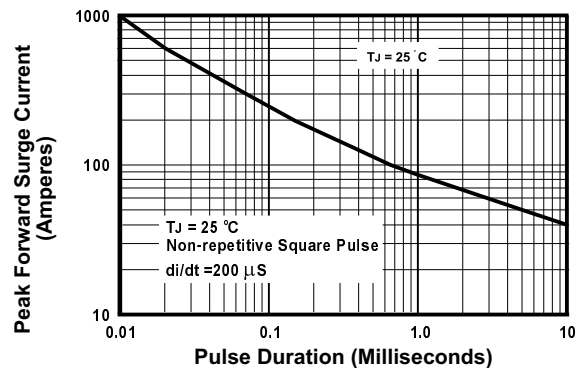

FIGURE 6. PEAK FORWARD SURGE CURRENT