

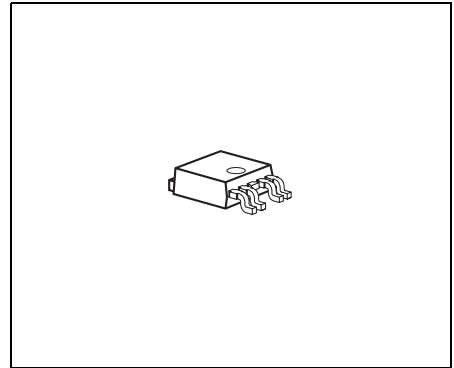

## Features

- Output tracking tolerance to reference  $\leq \pm 0.2\%$
- Output voltage adjust down to 1.5 V
- 250 mA output current capability
- Enable function
- Very low current consumption in OFF mode
- Wide operation range: up to 40 V
- Wide temperature range:  $-40\text{ °C} \leq T_j \leq 150\text{ °C}$
- Output protected against short circuit to GND and Battery
- Overtemperature protection
- Reverse polarity proof
- Green Product (RoHS compliant)
- AEC Qualified



## Short Functional Description

The **TLE 4252** is a monolithic integrated low-drop voltage tracking regulator in a very small SMD package PG-TO252-5-11. It is designed to supply off-board systems, e.g. sensors in engine management systems under the severe conditions of automotive applications. Therefore the device is equipped with additional protection functions against reverse polarity and short circuit to GND and battery.

With supply voltages up to 40 V the output voltage follows a reference voltage applied at the adjust input with high accuracy. The reference voltage applied directly to the adjust input or by an e.g. external resistor divider can be 1.5 V at minimum.

The output is able to drive loads up to 250 mA at minimum while they follow e.g. the 5 V output of a main voltage regulator as reference with high accuracy.

The **TLE 4252** tracker can be switched into stand-by mode to reduce the current consumption to very low values. This feature makes the IC suitable for low power battery applications.

Type	Package
TLE 4252 D	PG-TO252-5-11

**Block Diagram**

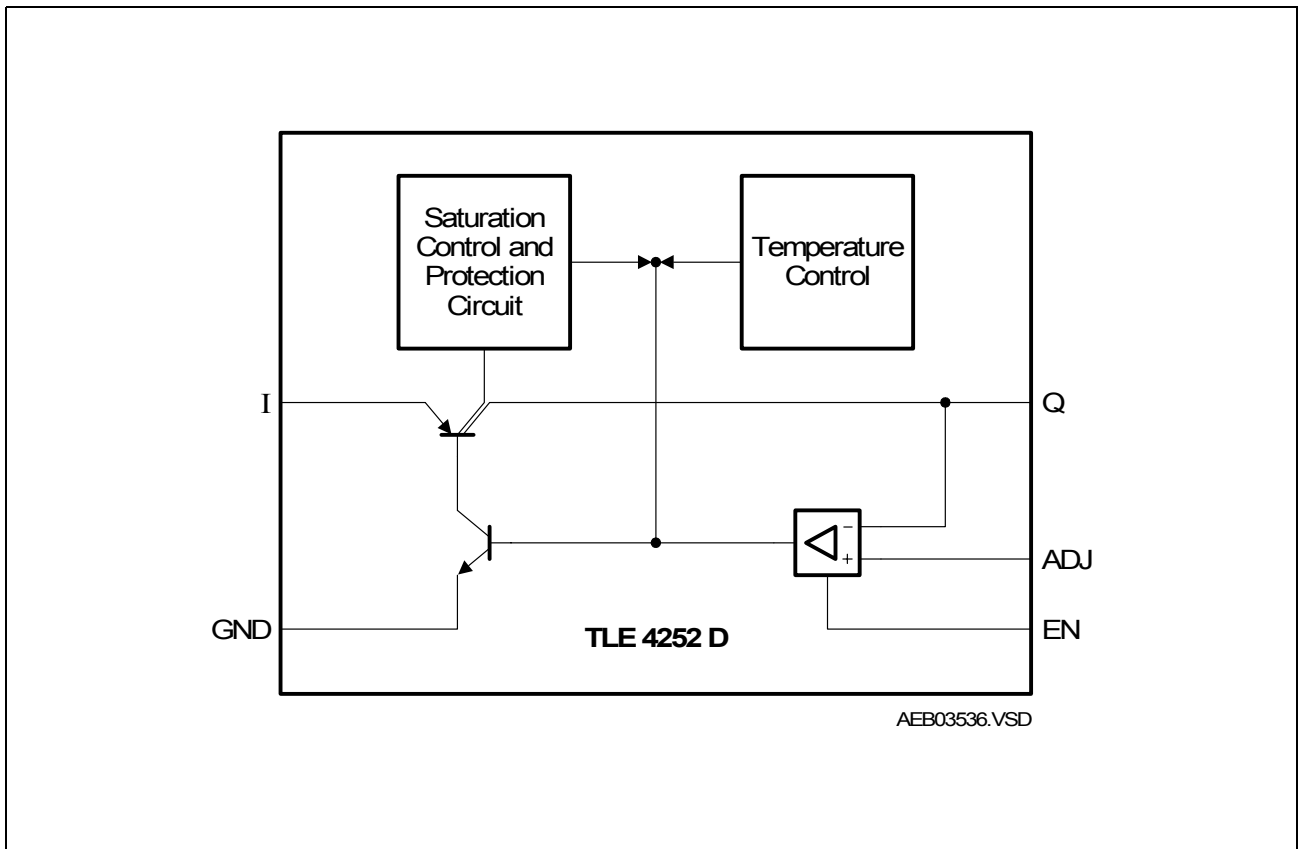

**Figure 1 Internal Circuit Blocks**

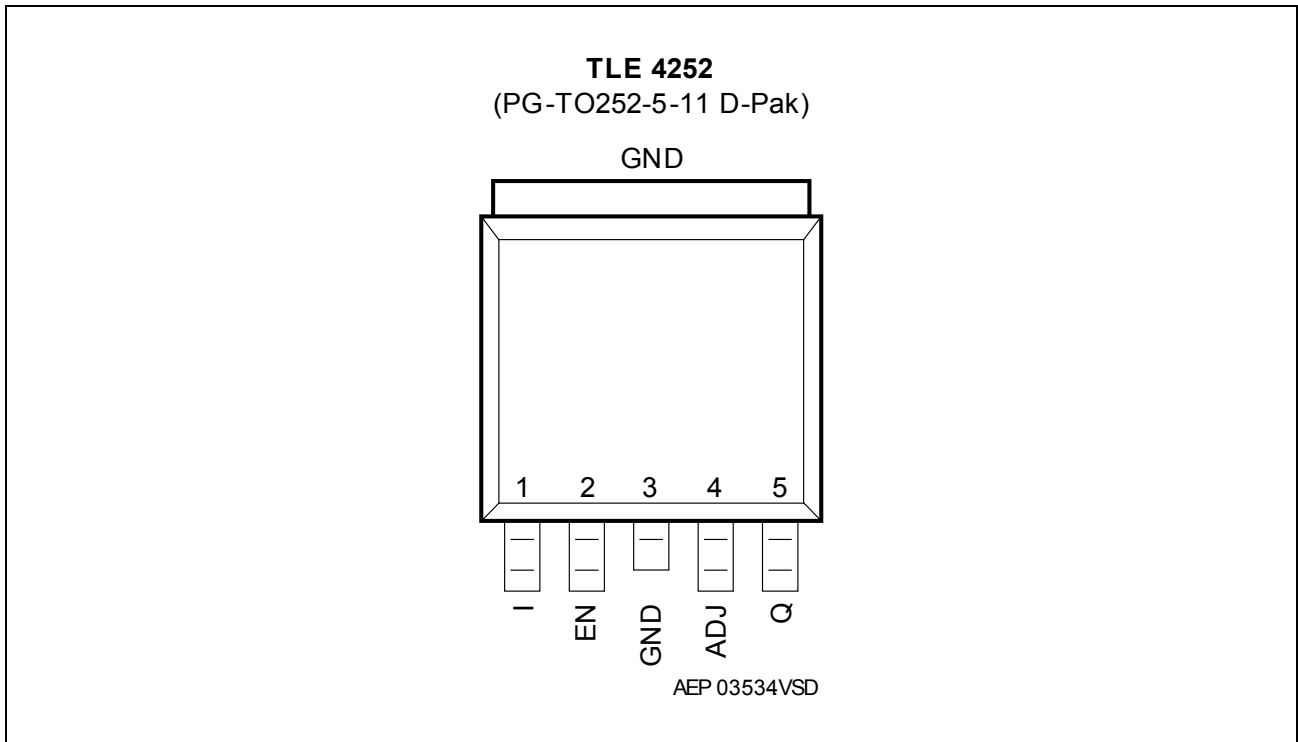

**Figure 2 Pin Configuration** (Draft, subject to alternation!)

**Table 1 Pin Definitions and Functions** (draft, subject to alternation)

Pin No.	Symbol	Function
1	I	<b>Supply voltage input;</b> Input for battery or a pre-regulated voltage of a e.g. DC to DC converter.
2	EN	<b>Enable input for tracker;</b> An active high signal turns on the device, with active low the tracker is turned off.
3	GND	<b>Ground;</b> Connected to the heatsink of the package.
4	ADJ	<b>Adjust input for tracker;</b> Input for the reference voltage which can be connected directly or by voltage divider to the reference (see <a href="#">Application Information</a> ).
5	Q	<b>Output voltage of tracker;</b> For a stable operation to avoid ringing at the output connect a capacitor of $C_Q \geq 10 \mu\text{F}$ and $0 \leq \text{ESR} \leq 5 \Omega$ to GND.

**Table 2 Absolute Maximum Ratings**

Parameter	Symbol	Limit Values		Unit	Remarks
		Min.	Max.		
<b>Supply Voltage Input I</b>					
Voltage	$V_I$	-42	45	V	–
Current	$I_I$	–	–	A	Limited internally
<b>Enable Input EN</b>					
Voltage	$V_{EN}$	-42	45	V	–
Current	$I_{EN}$	–	–	A	Limited internally
<b>Adjust Input ADJ</b>					
Voltage	$V_{ADJ}$	-42	45	V	–
Current	$I_{ADJ}$	–	–	A	Limited internally
<b>Output Q</b>					
Voltage	$V_Q$	-2	45	V	–
Current	$I_Q$	–	–	A	Limited internally
<b>Temperature</b>					
Junction temperature	$T_j$	-40	150	°C	–
Storage temperature	$T_{stg}$	-50	150	°C	–
<b>ESD-Protection</b>					
Voltage	$V_{ESD}$	-2	2	kV	Human Body Model (HBM)

*Note: Maximum ratings are absolute ratings, exceeding one of these values may cause irreversible damage to the integrated circuit!*

**Table 3 Operating Range**

Parameter	Symbol	Limit Values			Unit	Remarks
		Min.	Typ.	Max.		
<b>In- and Output Voltage</b>						
Supply voltage	$V_I$	3.5	–	40	V	$V_I > V_{ADJ} + V_{dr}$
Enable input voltage	$V_{EN}$	0	–	40	V	–
Adjust input voltage	$V_{ADJ}$	1.5	–	40	V	–
Adjust input voltage	$V_{ADJ}$	0	–	1.5	V	$V_Q \leq V_{ADJ} + \Delta V_Q$
Error amplifier common mode range	$CMR$	1.5	–	$V_I - 0.5$	V	$V_Q \leq V_{ADJ} + \Delta V_Q$ with $V_{FB} = V_Q$
<b>Temperature</b>						
Junction temperature	$T_j$	-40	–	150	°C	–
<b>Thermal Resistance PG-T0252-5-11</b>						
Junction to ambient	$R_{thj-a}$	–	–	144	K/W	Footprint only <sup>1)</sup>
Junction to ambient	$R_{thj-a}$	–	–	78	K/W	Heat sink area 300 mm <sup>2</sup> <sup>1)</sup>
Junction to ambient	$R_{thj-a}$	–	–	55	K/W	Heat sink area 600 mm <sup>2</sup> <sup>1)</sup>
Junction to case	$R_{thj-c}$	–	–	2	K/W	–

1) Worst case regarding peak temperature; zero airflow; mounted on FR4; 80 × 80 × 1.5 mm<sup>3</sup>; 35 μ Cu; 5 μ Sn

*Note: Within this operating range the IC is functional. The electrical characteristics, however, are not guaranteed over this full range given above.*

**Table 4 Electrical Characteristics**
 $V_I = 13.5 \text{ V}; 1.5 \text{ V} \leq V_{\text{ADJ}} \leq V_I - 0.6 \text{ V}; -40 \text{ }^\circ\text{C} < T_j < 150 \text{ }^\circ\text{C};$  unless otherwise specified

Parameter	Symbol	Limit Values			Unit	Test Condition
		Min.	Typ.	Max.		
<b>Regulator Performance, Tracker Output Q</b>						
Output voltage tracking accuracy $\Delta V_Q = V_{\text{ADJ}} - V_Q$	$\Delta V_Q$	-10	–	10	mV	$4.5 \text{ V} < V_I < 26 \text{ V};$ $1 \text{ mA} < I_Q < 200 \text{ mA};$
Output voltage tracking accuracy $\Delta V_Q = V_{\text{ADJ}} - V_Q$	$\Delta V_Q$	-10	–	10	mV	$3.5 \text{ V} < V_I < 32 \text{ V};$ $10 \text{ mA} < I_Q < 100 \text{ mA};$
		-25	–	25	mV	$3.5 \text{ V} < V_I < 4.5 \text{ V};$ $1 \text{ mA} < I_Q < 200 \text{ mA};$
Drop voltage	$V_{\text{dr}}$	–	280	600	mV	$I_Q = 200 \text{ mA};$ $V_{\text{ADJ}} > 3.5 \text{ V};$ $V_{\text{EN}} = V_{\text{EN, on}}^{1)}$
Output current	$I_Q$	250	350	500	mA	$V_Q = 5.0 \text{ V}^{2)}$
Output capacitor	$C_Q$	10	–	–	$\mu\text{F}$	$0 \leq \text{ESR} \leq 5 \Omega$ at 10 kHz
Current consumption $I_q = I_I - I_Q$	$I_q$	–	10	25	mA	$I_Q = 200 \text{ mA};$ $V_Q = 5 \text{ V}$
Current consumption $I_q = I_I - I_Q$	$I_q$	–	100	150	$\mu\text{A}$	$I_Q < 100 \mu\text{A};$ $T_j < 85 \text{ }^\circ\text{C}; V_{\text{EN}} = 5 \text{ V}$
Quiescent current (stand-by) $I_q = I_I - I_Q$	$I_q$	–	0	2	$\mu\text{A}$	$V_{\text{EN}} = 0 \text{ V};$ $V_{\text{EN/ADJ}} = 0 \text{ V};$ $T_j < 85 \text{ }^\circ\text{C}$
Reverse current	$I_r$	–	0.5	5	mA	$V_Q = 16 \text{ V}; V_I = 0 \text{ V}$
Load regulation	$\Delta V_Q$	–	–	10	mV	$1 \text{ mA} < I_Q < 200 \text{ mA}$
Line regulation	$\Delta V_Q$	–	–	10	mV	$5 \text{ V} < V_I < 32 \text{ V};$ $I_Q = 5 \text{ mA}$
Power supply ripple rejection	$PSSR$	–	60	–	dB	$f_{\text{I, ripple}} = 100 \text{ Hz};$ $V_{\text{I, ripple}} = 0.5 \text{ Vpp}^{3)}$

**Table 4 Electrical Characteristics (cont'd)**

$V_I = 13.5\text{ V}$ ;  $1.5\text{ V} \leq V_{ADJ} \leq V_I - 0.6\text{ V}$ ;  $-40\text{ }^\circ\text{C} < T_j < 150\text{ }^\circ\text{C}$ ; unless otherwise specified

Parameter	Symbol	Limit Values			Unit	Test Condition
		Min.	Typ.	Max.		
<b>Adjust Input ADJ</b>						
Input biasing current	$I_{ADJ}$	–	0.1	0.5	$\mu\text{A}$	$V_{ADJ} = 5\text{ V}$
<b>Enable Input EN</b>						
Device on voltage range	$V_{EN, on}$	2.0	–	40	V	$V_Q$ settled
Device off voltage range	$V_{EN, off}$	0	–	0.8	V	$V_Q < 0.1\text{ V}$
Input current	$I_{EN}$	-1	2	5	$\mu\text{A}$	$V_{EN} = 5\text{ V}$
EN pull-down resistor	$R_{EN}$	–	1.5	–	$\text{M}\Omega$	–

- 1) Measured when the output voltage  $V_Q$  has dropped 100 mV from the nominal value.
- 2) The current limit depends also on the input voltage, see graph output current vs. input voltage in the diagrams section.
- 3) Specified by design. Not subject to production test.

Application Information

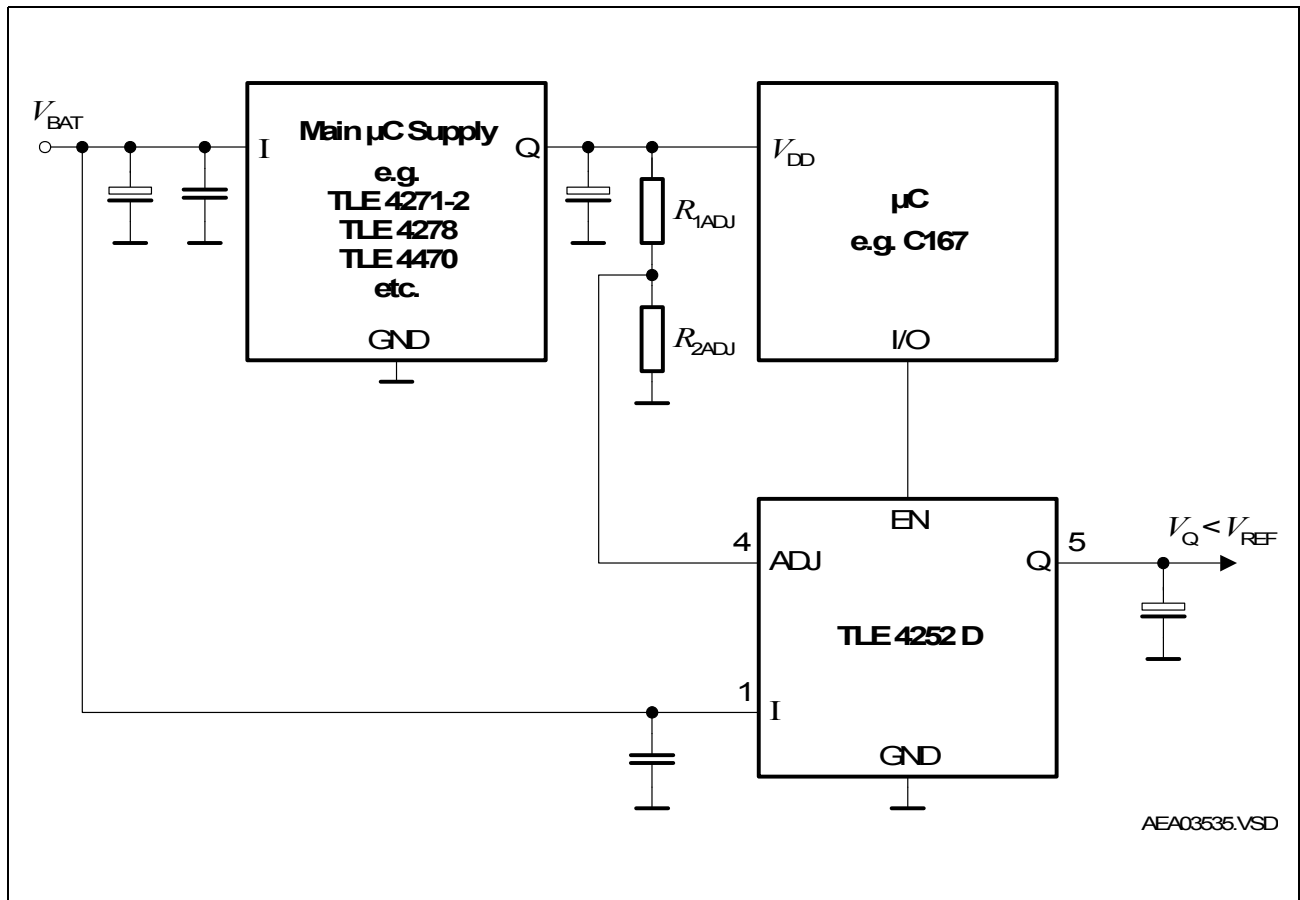

**Figure 3 Application Circuit: Output Voltage < Reference Voltage**

**Figure 3** shows a typical application circuit with  $V_Q < V_{REF}$ . Of course, also  $V_Q = V_{REF}$  is feasible by directly connecting the reference pin of the TLE 4252 D to the appropriate voltage level without voltage divider.

The output voltage calculates to:

$$V_Q = V_{REF} \times \left( \frac{R_{2ADJ}}{R_{1ADJ} + R_{2ADJ}} \right) \tag{1}$$



Diagrams

Output Current Limit  $I_Q$  versus Input Voltage  $V_I$

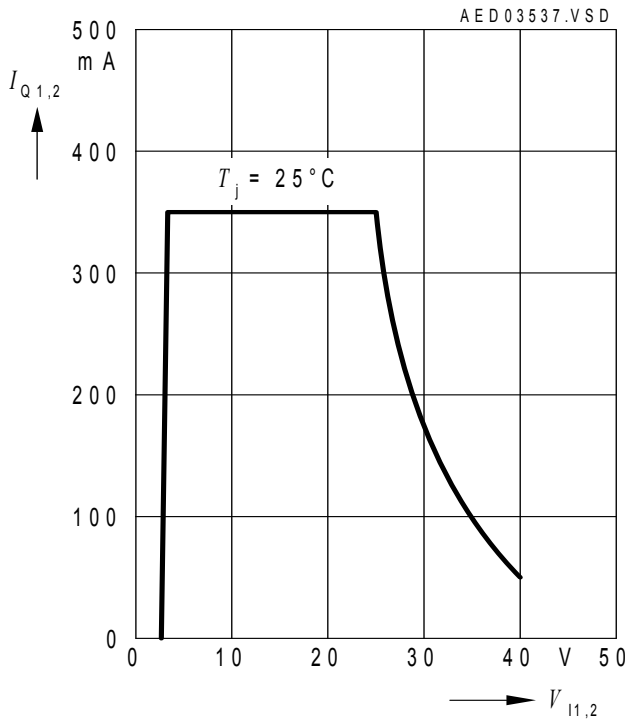

Drop Voltage  $V_{DR}$  versus Output Current  $I_Q$

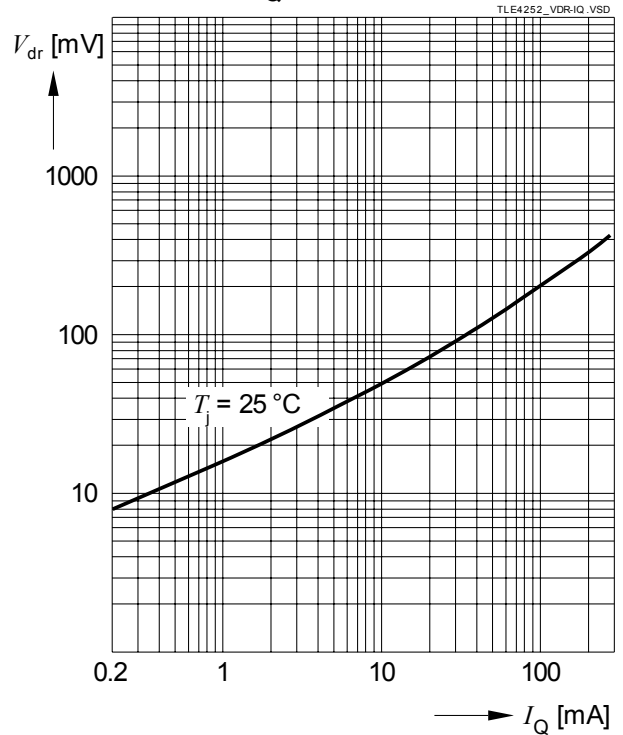

Current Consumption  $I_q$  versus Output Current  $I_Q$

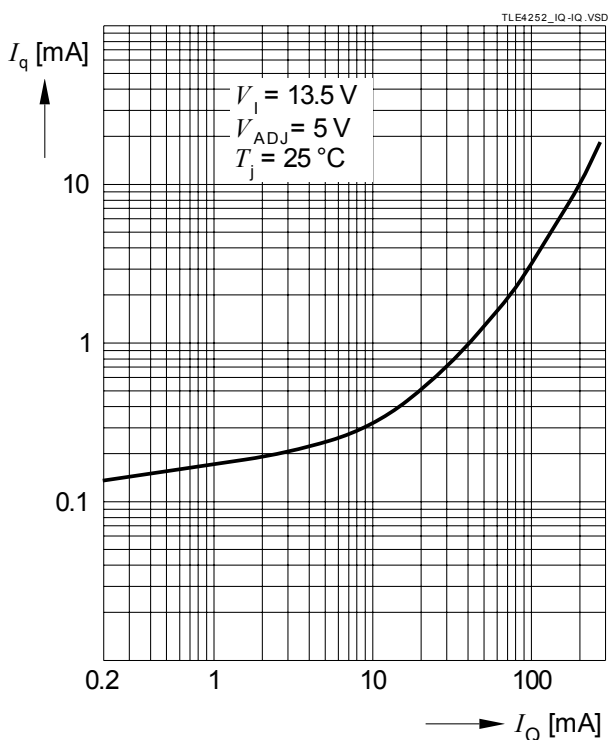

Drop Voltage  $V_{DR}$  versus Junction Temperature  $T_j$

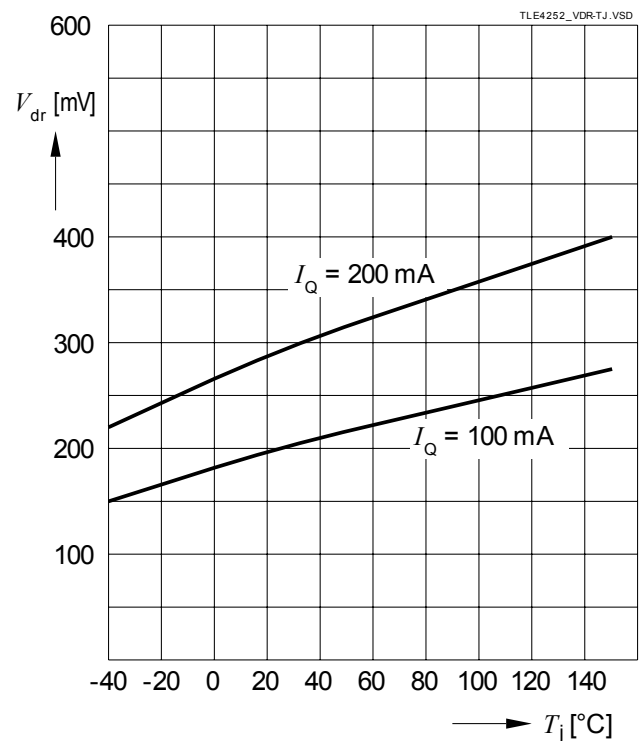

Package Outlines

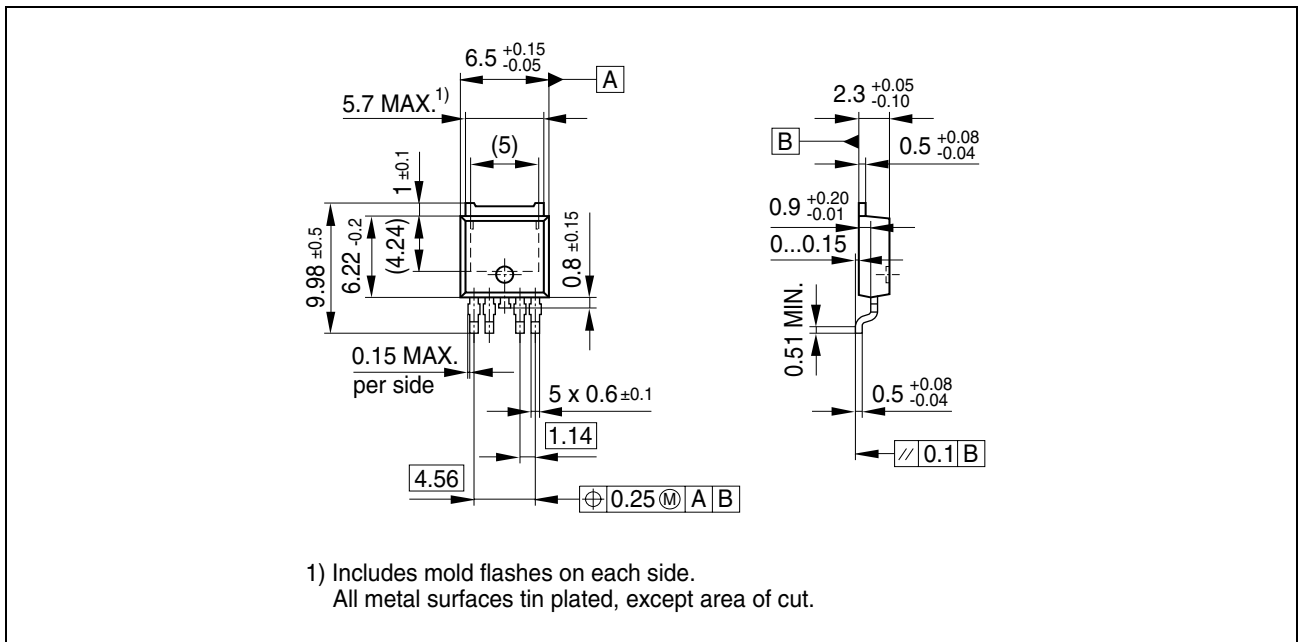

Figure 4 PG-TO252-5-11 (Plastic Transistor Single Outline)

Green Product (RoHS compliant)

To meet the world-wide customer requirements for environmentally friendly products and to be compliant with government regulations the device is available as a green product. Green products are RoHS-Compliant (i.e Pb-free finish on leads and suitable for Pb-free soldering according to IPC/JEDEC J-STD-020).

You can find all of our packages, sorts of packing and others in our Infineon Internet Page “Products”: <http://www.infineon.com/products>.

SMD = Surface Mounted Device

Dimensions in mm

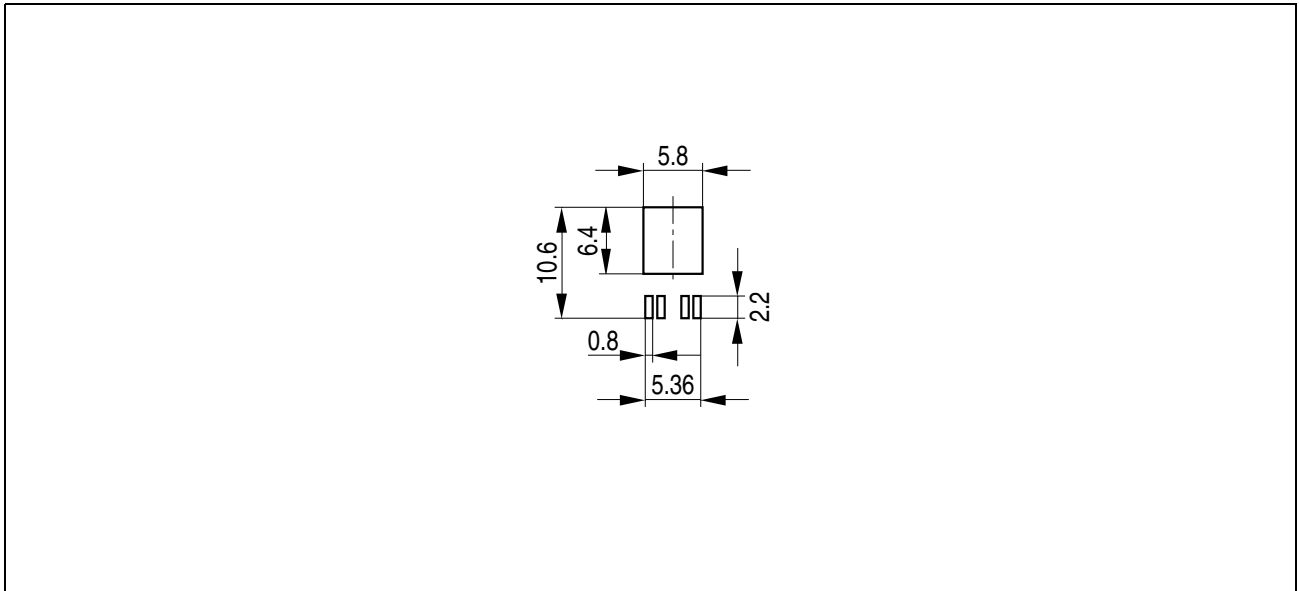

**Figure 5** Foot Print for PG-TO-252-5-11 (Plastic Transistor Single Outline)

## Revision History

Version	Date	Changes
Rev. 1.4	2007-03-20	Initial version of RoHS-compliant derivate of TLE 4252 <b>Page 1</b> : AEC certified statement added <b>Page 1</b> and <b>Page 10</b> : RoHS compliance statement and Green product feature added <b>Page 1</b> and <b>Page 10</b> : Package changed to RoHS compliant version Legal Disclaimer updated

**Edition 2007-03-20**

**Published by  
Infineon Technologies AG  
81726 Munich, Germany**

**© 2007 Infineon Technologies AG  
All Rights Reserved.**

#### **Legal Disclaimer**

The information given in this document shall in no event be regarded as a guarantee of conditions or characteristics. With respect to any examples or hints given herein, any typical values stated herein and/or any information regarding the application of the device, Infineon Technologies hereby disclaims any and all warranties and liabilities of any kind, including without limitation, warranties of non-infringement of intellectual property rights of any third party.

#### **Information**

For further information on technology, delivery terms and conditions and prices, please contact the nearest Infineon Technologies Office ([www.infineon.com](http://www.infineon.com)).

#### **Warnings**

Due to technical requirements, components may contain dangerous substances. For information on the types in question, please contact the nearest Infineon Technologies Office.

Infineon Technologies components may be used in life-support devices or systems only with the express written approval of Infineon Technologies, if a failure of such components can reasonably be expected to cause the failure of that life-support device or system or to affect the safety or effectiveness of that device or system. Life support devices or systems are intended to be implanted in the human body or to support and/or maintain and sustain and/or protect human life. If they fail, it is reasonable to assume that the health of the user or other persons may be endangered.