

P-Channel 20-V (D-S) MOSFET

PRODUCT SUMMARY		
V _{DS} (V)	R _{DS(on)} (Ω)	I _D (A) ^{a, e}
- 20	0.041 at V _{GS} = - 4.5 V	- 7.1
	0.055 at V _{GS} = - 2.5 V	- 6.1

FEATURES

- Halogen-free According to IEC 61249-2-21 Definition
- TrenchFET[®] Power MOSFET
- Typical ESD Protection: 3000 V
- Gate-Source OVP
- Compliant to RoHS Directive 2002/95/EC



RoHS
COMPLIANT
HALOGEN
FREE

APPLICATIONS

- Load Switch
- Battery Switch
- Charger Switch
- Gate-Source Over Voltage Protection (see page 3)

MICRO FOOT[®]

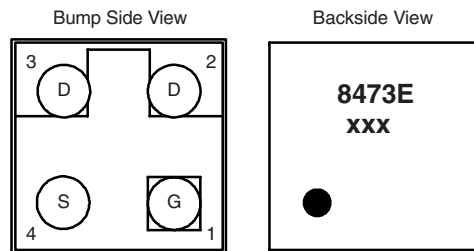

Device Marking: 8473E
xxx = Date/Lot Traceability Code

Ordering Information: Si8473EDB-T1-E1 (Lead (Pb)-free and Halogen-free)

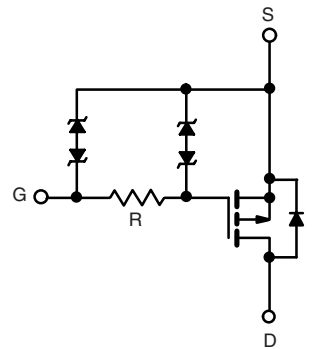

P-Channel MOSFET

ABSOLUTE MAXIMUM RATINGS T _A = 25 °C, unless otherwise noted			
Parameter	Symbol	Limit	Unit
Drain-Source Voltage	V _{DS}	- 20	V
Gate-Source Voltage	V _{GS}	± 12	
Continuous Drain Current (T _J = 150 °C)	I _D	T _A = 25 °C	- 7.1 ^a
		T _A = 70 °C	- 5.7 ^a
		T _A = 25 °C	- 4.5 ^b
		T _A = 70 °C	- 3.6 ^b
Pulsed Drain Current	I _{DM}	- 25	A
Continuous Source-Drain Diode Current	I _S	T _A = 25 °C	
		T _A = 25 °C	- 0.92 ^b
Maximum Power Dissipation	P _D	T _A = 25 °C	2.7 ^a
		T _A = 70 °C	1.8 ^a
		T _A = 25 °C	1.1 ^b
		T _A = 70 °C	0.73 ^b
Operating Junction and Storage Temperature Range	T _J , T _{stg}	- 55 to 150	°C
Package Reflow Conditions ^c	VPR	260	
	IR/Convection	260	

Notes:

- Surface mounted on 1" x 1" FR4 board with full copper, t = 5 s.
- Surface mounted on 1" x 1" FR4 board with minimum copper, t = 5 s.
- Refer to IPC/JEDEC (J-STD-020C), no manual or hand soldering.
- In this document, any reference to case represents the body of the MICRO FOOT device and foot is the bump.
- Based on T_A = 25 °C.

THERMAL RESISTANCE RATINGS

Parameter		Symbol	Typical	Maximum	Unit
Maximum Junction-to-Ambient ^{a, b}	t = 5 s	R _{thJA}	35	45	°C/W
Maximum Junction-to-Ambient ^{c, d}	t = 5 s	R _{thJA}	85	110	

Notes:

- a. Surface mounted on 1" x 1" FR4 board with full copper, t = 5 s.
 b. Maximum under steady state conditions is 85 °C/W.
 c. Surface mounted on 1" x 1" FR4 board with minimum copper, t = 5 s.
 d. Maximum under steady state conditions is 175 °C/W.

SPECIFICATIONS T_J = 25 °C, unless otherwise noted

Parameter	Symbol	Test Conditions	Min.	Typ.	Max.	Unit
Static						
Drain-Source Breakdown Voltage	V _{DS}	V _{GS} = 0 V, I _D = - 250 μA	- 20			V
V _{DS} Temperature Coefficient	ΔV _{DS} /T _J	I _D = - 250 μA		- 14		mV/°C
V _{GS(th)} Temperature Coefficient	ΔV _{GS(th)} /T _J		3.4			
Gate-Source Threshold Voltage	V _{GS(th)}	V _{DS} = V _{GS} , I _D = - 250 μA	- 0.6		- 1.5	V
Gate-Source Leakage	I _{GSS}	V _{DS} = 0 V, V _{GS} = ± 4.5 V			± 5	μA
		V _{DS} = 0 V, V _{GS} = ± 12 V			± 1	mA
Zero Gate Voltage Drain Current	I _{DSS}	V _{DS} = - 20 V, V _{GS} = 0 V			- 1	μA
		V _{DS} = - 20 V, V _{GS} = 0 V, T _J = 70 °C			- 10	
On-State Drain Current ^a	I _{D(on)}	V _{DS} ≤ - 5 V, V _{GS} = - 4.5 V	- 5			A
Drain-Source On-State Resistance ^a	R _{DS(on)}	V _{GS} = - 4.5 V, I _D = - 1 A		0.034	0.041	Ω
		V _{GS} = - 2.5 V, I _D = - 1 A		0.046	0.055	
Forward Transconductance ^a	g _{fs}	V _{DS} = - 10 V, I _D = - 1 A		11		S
Dynamic^b						
Gate Resistance	R _g	V _{GS} = - 0.1 V, f = 1 MHz		3.6		kΩ
Turn-On Delay Time	t _{d(on)}	V _{DD} = - 10 V, R _L = 10 Ω I _D ≅ - 1 A, V _{GEN} = - 4.5 V, R _g = 1 Ω		15	25	μs
Rise Time	t _r		50	75		
Turn-Off Delay Time	t _{d(off)}		55	85		
Fall Time	t _f		100	150		
Turn-On Delay Time	t _{d(on)}		7	15		
Rise Time	t _r	V _{DD} = - 10 V, R _L = 10 Ω I _D ≅ - 1 A, V _{GEN} = - 10 V, R _g = 1 Ω		18	30	μs
Turn-Off Delay Time	t _{d(off)}		155	235		
Fall Time	t _f		110	165		
Drain-Source Body Diode Characteristics						
Continuous Source-Drain Diode Current	I _S	T _A = 25 °C			- 2.3 ^c	A
Pulse Diode Forward Current	I _{SM}				- 25	
Body Diode Voltage	V _{SD}	I _S = - 1 A, V _{GS} = 0 V		- 0.85	- 1.2	V
Body Diode Reverse Recovery Time	t _{rr}	I _F = - 1 A, di/dt = 100 A/μs, T _J = 25 °C		30	60	ns
Body Diode Reverse Recovery Charge	Q _{rr}		17	35	nC	
Reverse Recovery Fall Time	t _a		13		ns	
Reverse Recovery Rise Time	t _b		17			

Notes:

- a. Pulse test; pulse width ≤ 300 μs, duty cycle ≤ 2 %.
 b. Guaranteed by design, not subject to production testing.
 c. Surface mounted on 1" x 1" FR4 board with full copper, t = 5 s.

Stresses beyond those listed under "Absolute Maximum Ratings" may cause permanent damage to the device. These are stress ratings only, and functional operation of the device at these or any other conditions beyond those indicated in the operational sections of the specifications is not implied. Exposure to absolute maximum rating conditions for extended periods may affect device reliability.

APPLICATION CIRCUIT EXAMPLE

Gate-Source protection from Over-Voltage in Reverse Polarity Protection Circuit

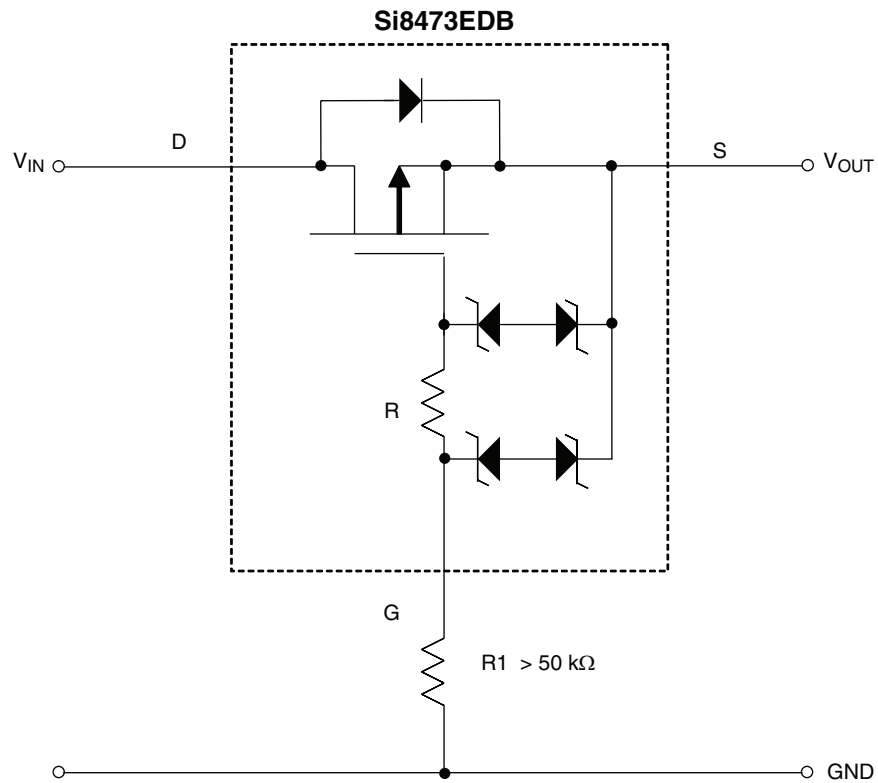

TYPICAL CHARACTERISTICS 25 °C, unless otherwise noted

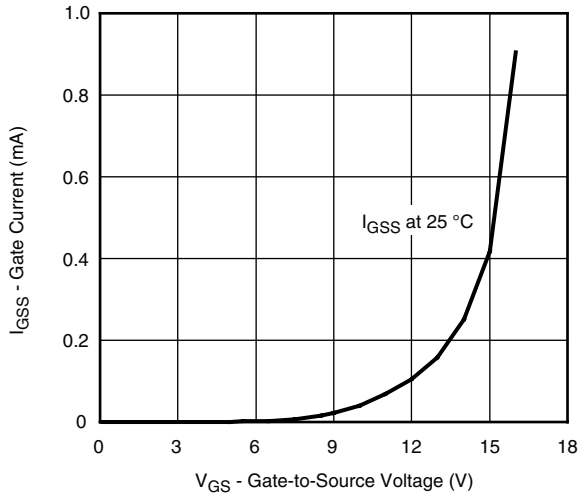

Gate Current vs. Gate-Source Voltage

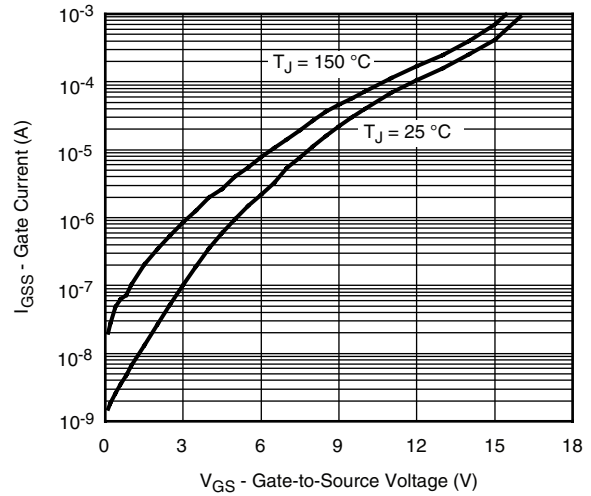

Gate Current vs. Gate-Source Voltage

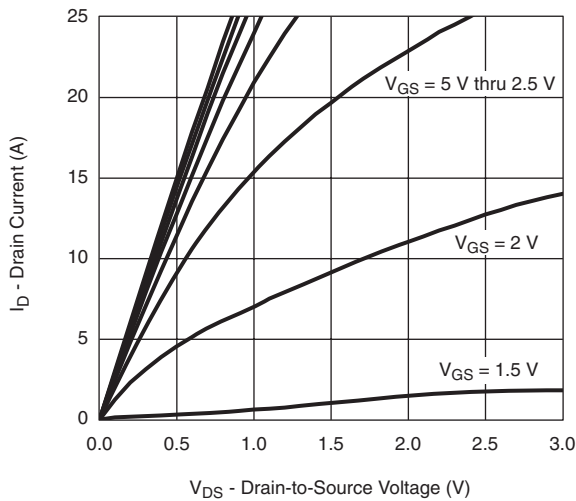

Output Characteristics

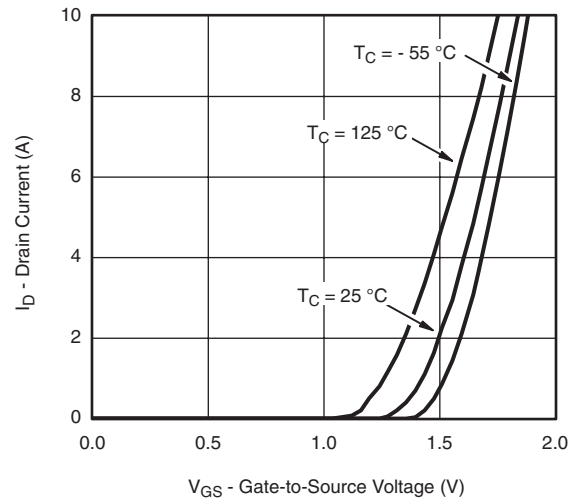

Transfer Characteristics

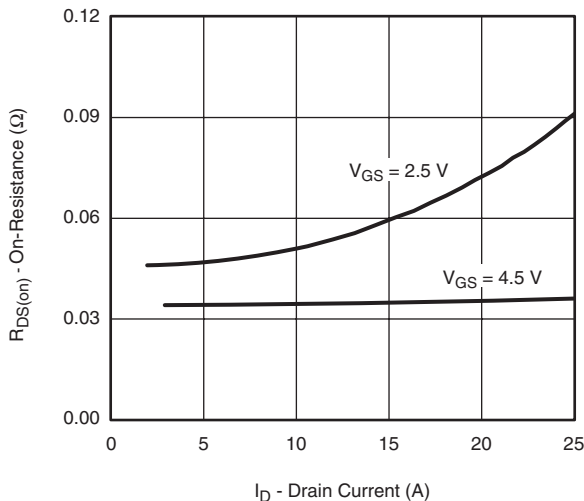

On-Resistance vs. Drain Current

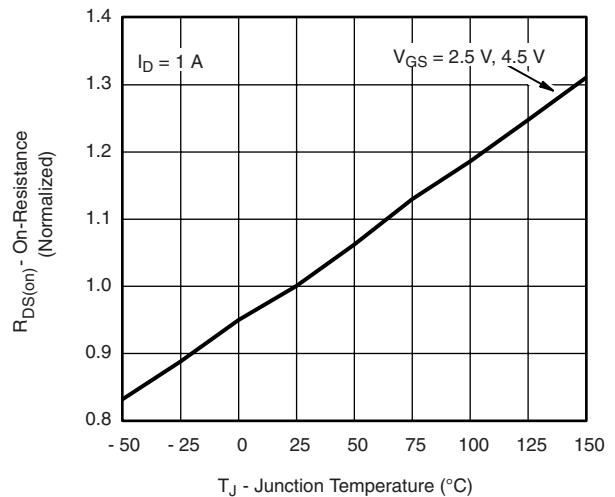

On-Resistance vs. Junction Temperature

TYPICAL CHARACTERISTICS 25 °C, unless otherwise noted

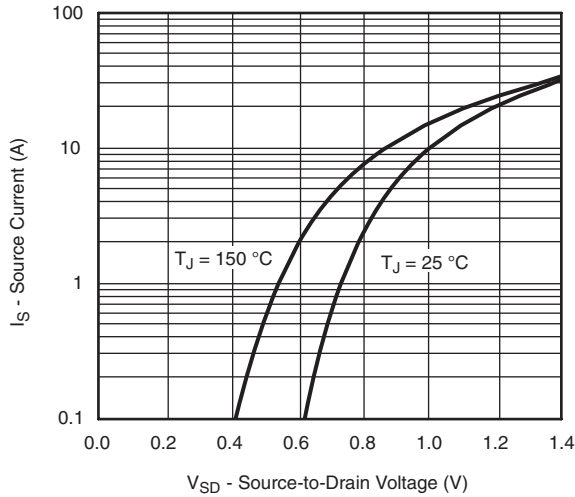

Source-Drain Diode Forward Voltage

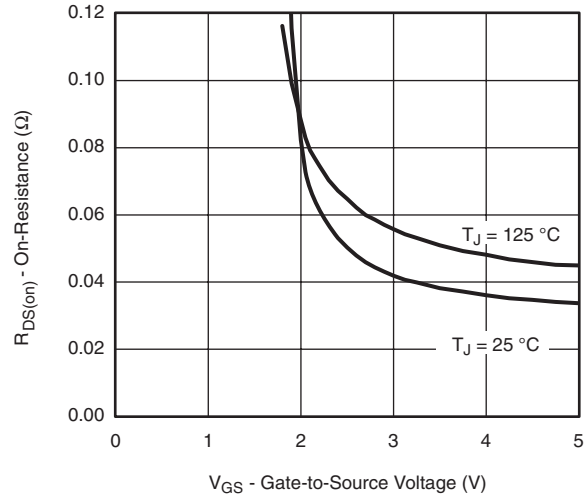

On-Resistance vs. Gate-to-Source Voltage

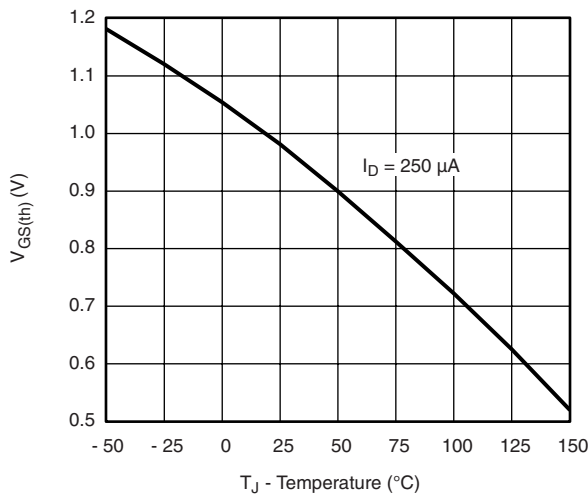

Threshold Voltage

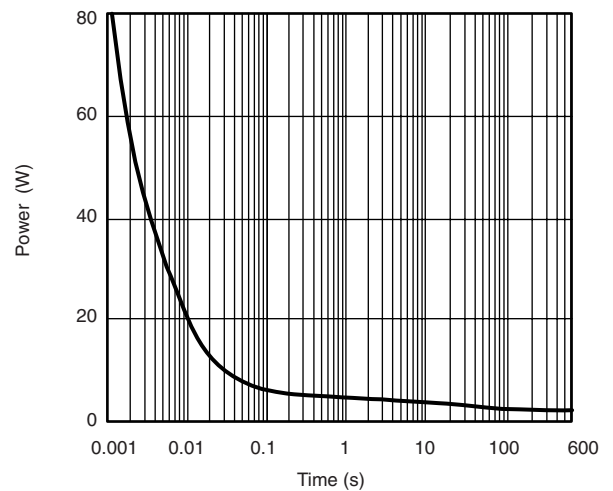

Single Pulse Power, Junction-to-Ambient

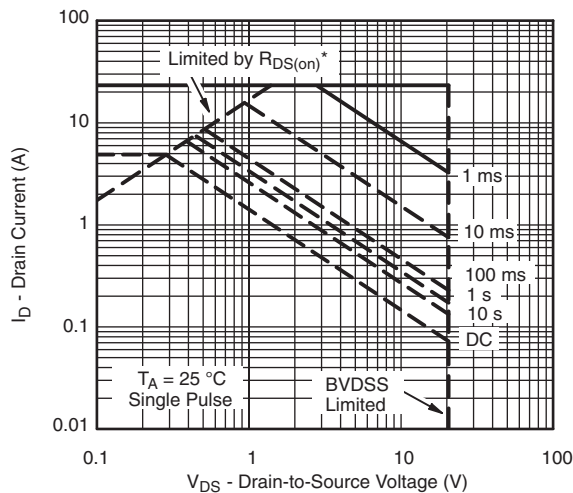

* $V_{GS} >$ minimum V_{GS} at which $R_{DS(on)}$ is specified

Safe Operating Area, Junction-to-Ambient

TYPICAL CHARACTERISTICS 25 °C, unless otherwise noted

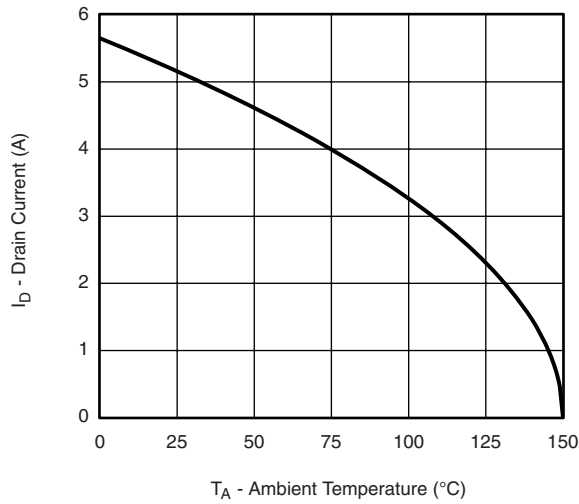

Current Derating*

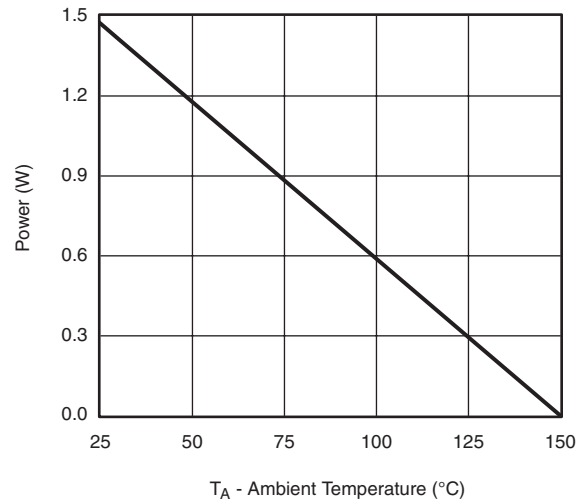

Power Derating

Notes:
When Mounted on 1" x 1" FR4 with full Copper.

* The power dissipation P_D is based on T_{J(max)} = 150 °C, using junction-to-case thermal resistance, and is more useful in settling the upper dissipation limit for cases where additional heatsinking is used. It is used to determine the current rating, when this rating falls below the package limit.

TYPICAL CHARACTERISTICS 25 °C, unless otherwise noted

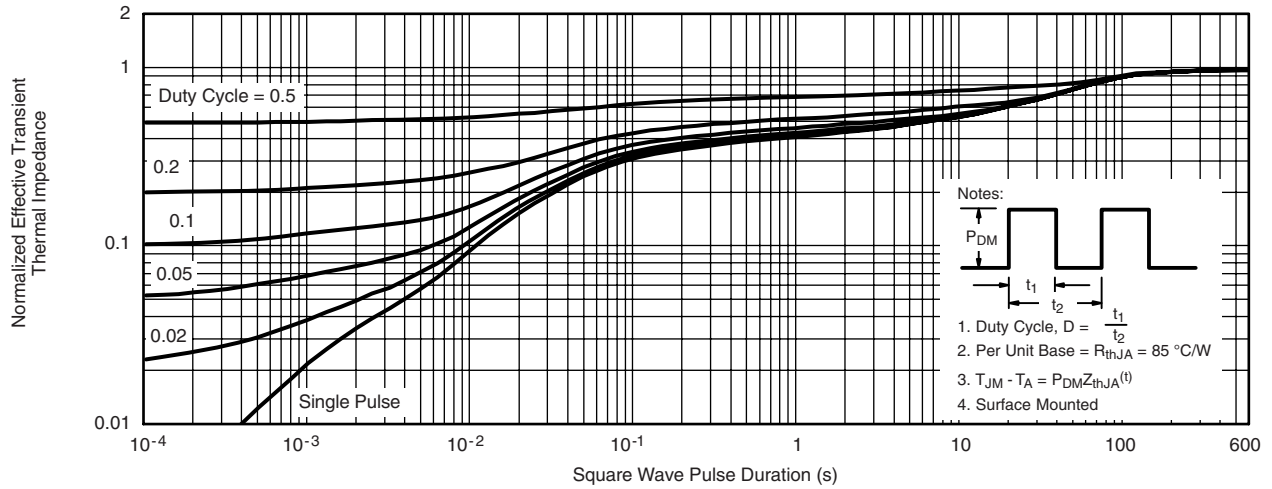

Normalized Thermal Transient Impedance, Junction-to-Ambient (1" x 1" FR4 Board with Full Copper)

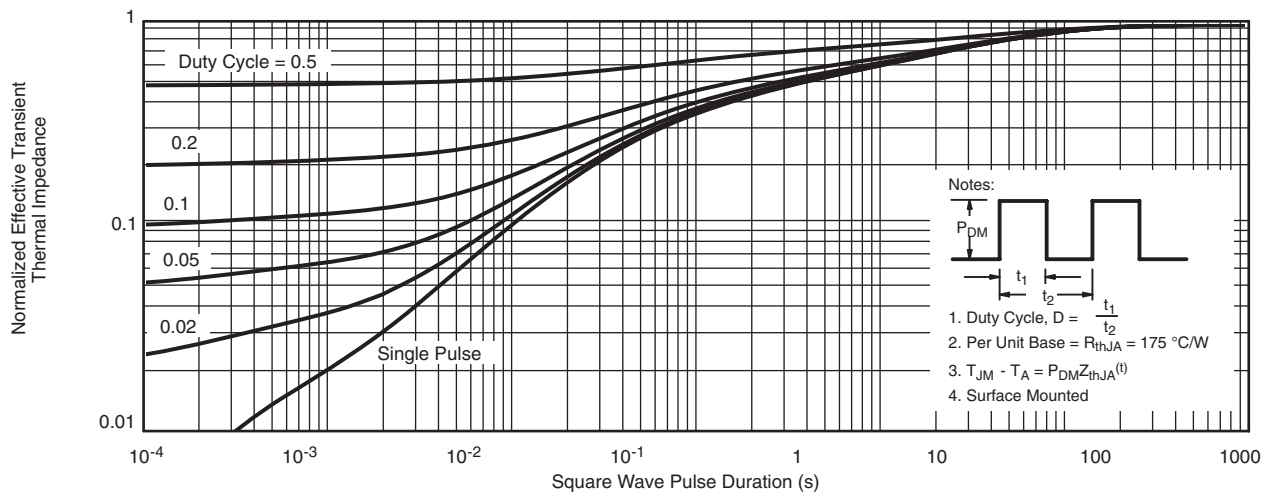

Normalized Thermal Transient Impedance, Junction-to-Ambient (1" x 1" FR4 Board with Minimum Copper)

PACKAGE OUTLINE

MICRO FOOT: 4-BUMP (2 x 2, 0.8 mm PITCH)

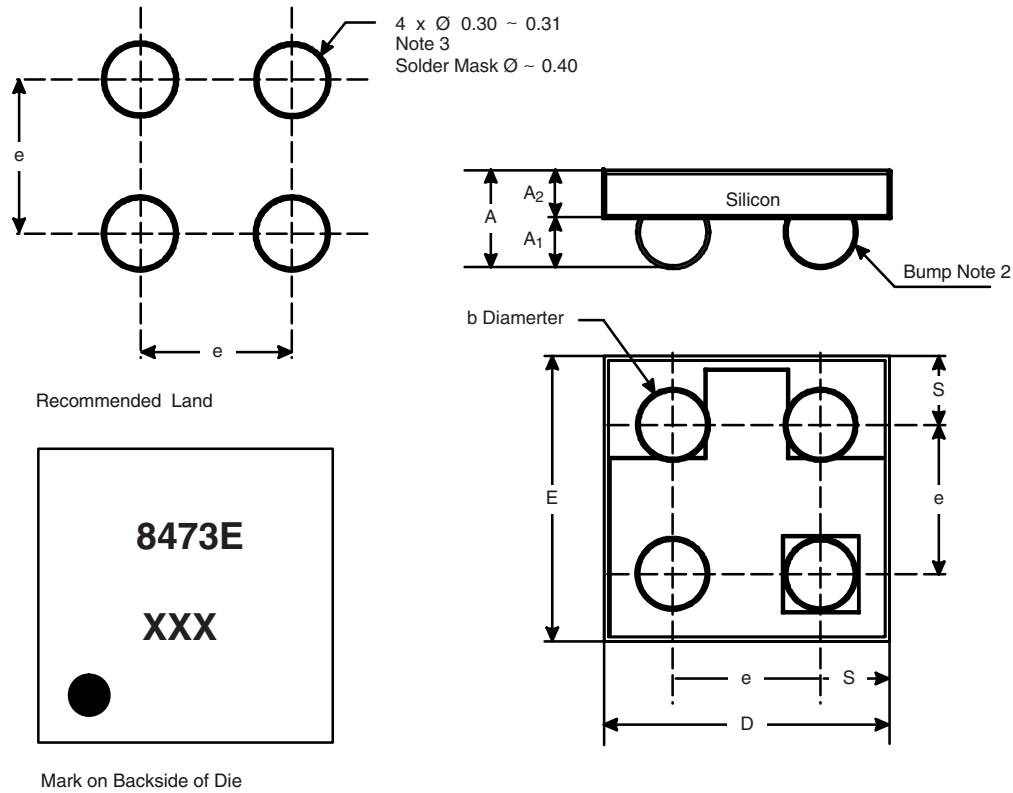

Notes (Unless otherwise specified):

1. Laser mark on the silicon die back, coated with a thin metal.
2. Bumps are Eutectic solder 63/57 Sn/Pb.
3. Non-solder mask defined copper landing pad.
4. The flat side of wafers is oriented at the bottom.

Dim.	Millimeters ^a		Inches	
	Min.	Max.	Min.	Max.
A	0.600	0.650	0.0236	0.0256
A ₁	0.260	0.290	0.0102	0.0114
A ₂	0.340	0.360	0.0134	0.0142
b	0.370	0.410	0.0146	0.0161
D	1.520	1.600	0.0598	0.0630
E	1.520	1.600	0.0598	0.0630
e	0.750	0.850	0.0295	0.0335
S	0.370	0.380	0.0146	0.0150

Notes:

- a. Use millimeters as the primary measurement.

Vishay Siliconix maintains worldwide manufacturing capability. Products may be manufactured at one of several qualified locations. Reliability data for Silicon Technology and Package Reliability represent a composite of all qualified locations. For related documents such as package/tape drawings, part marking, and reliability data, see www.vishay.com/ppg?65037.



Disclaimer

All product specifications and data are subject to change without notice.

Vishay Intertechnology, Inc., its affiliates, agents, and employees, and all persons acting on its or their behalf (collectively, "Vishay"), disclaim any and all liability for any errors, inaccuracies or incompleteness contained herein or in any other disclosure relating to any product.

Vishay disclaims any and all liability arising out of the use or application of any product described herein or of any information provided herein to the maximum extent permitted by law. The product specifications do not expand or otherwise modify Vishay's terms and conditions of purchase, including but not limited to the warranty expressed therein, which apply to these products.

No license, express or implied, by estoppel or otherwise, to any intellectual property rights is granted by this document or by any conduct of Vishay.

The products shown herein are not designed for use in medical, life-saving, or life-sustaining applications unless otherwise expressly indicated. Customers using or selling Vishay products not expressly indicated for use in such applications do so entirely at their own risk and agree to fully indemnify Vishay for any damages arising or resulting from such use or sale. Please contact authorized Vishay personnel to obtain written terms and conditions regarding products designed for such applications.

Product names and markings noted herein may be trademarks of their respective owners.