

Q-band Power Amplifier

TGA4043-EPU

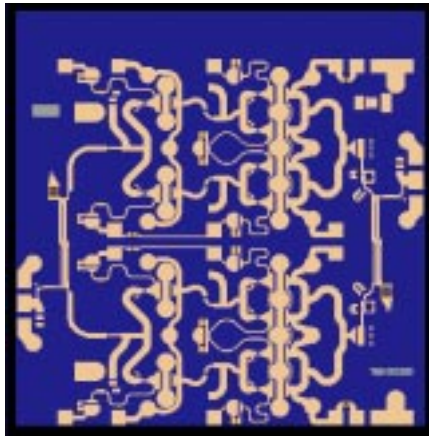

Key Features

- Frequency Range: 40-45 GHz
- 29 dBm Nominal Pout @ P1dB
- 10 dB Nominal Gain
- 0.25 um pHEMT Technology
- Bias 7V @ 500 mA
- Chip Dimensions 3.08 mm x 3.14 x 0.10 mm (0.121 x 0.124 x 0.004 in)

Primary Applications

- Point to Point Radio
- Point to Multipoint Radio
- Military Communications

Product Description

The TriQuint TGA4043-EPU is a compact High Power Amplifier MMIC for Q-band applications. The part is designed using TriQuint's proven standard 0.25 um gate power pHEMT production process.

The TGA4043-EPU provides a nominal 28 dBm of output power at 1 dB gain compression from 40-45 GHz with a small signal gain of 10 dB.

The part is ideally suited for low cost emerging markets such as Point-to-Point Radio and Point-to-Multi Point Communications.

The TGA4043-EPU is 100% DC and RF tested on-wafer to ensure performance compliance.

Measured Fixtured Data

Bias Conditions: Vd = 7V, Id = 500mA

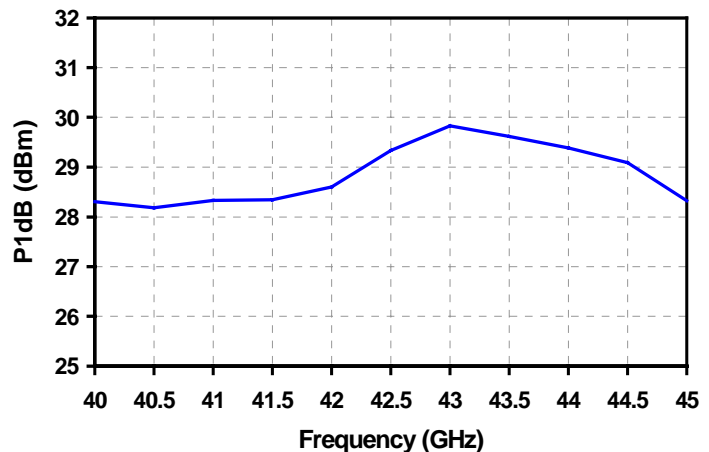
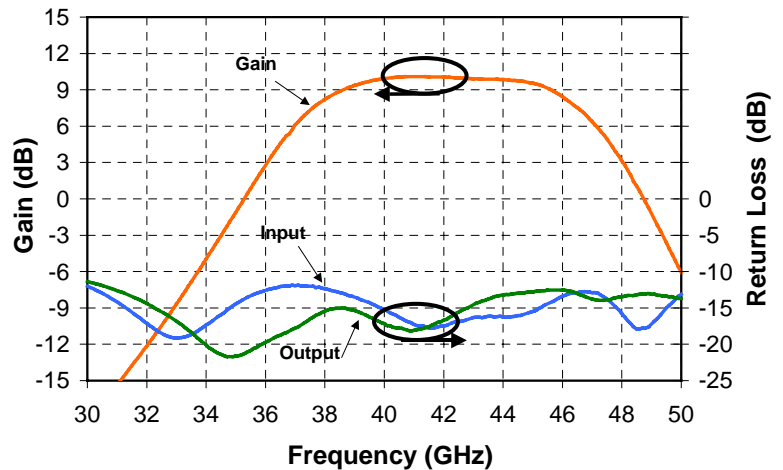

Note: Devices designated as EPU are typically early in their characterization process prior to finalizing all electrical and process specifications. Specifications are subject to change without notice

TABLE I
MAXIMUM RATINGS 1/

SYMBOL	PARAMETER	VALUE	NOTES
V ⁺	Positive Supply Voltage	8 V	2/
V ⁻	Negative Supply Voltage Range	-5V TO 0V	
I ⁺	Positive Supply Current	960 mA	2/
I _G	Gate Supply Current	56 mA	
P _{IN}	Input Continuous Wave Power	27 dBm	2/
P _D	Power Dissipation	4.6 W	2/, 3/
T _{CH}	Operating Channel Temperature	150 °C	4/, 5/
T _M	Mounting Temperature (30 Seconds)	320 °C	
T _{STG}	Storage Temperature	-65 to 150 °C	

- 1/ These ratings represent the maximum operable values for this device.
- 2/ Current is defined under no RF drive conditions. Combinations of supply voltage, supply current, input power, and output power shall not exceed P_D.
- 3/ When operated at this power dissipation with a base plate temperature of 70 °C, the median life is 1 E+6 hours.
- 4/ Junction operating temperature will directly affect the device median time to failure (T_M). For maximum life, it is recommended that junction temperatures be maintained at the lowest possible levels.
- 5/ These ratings apply to each individual FET.

TABLE II
DC PROBE TEST
(T_A = 25 °C, Nominal)

SYMBOL	PARAMETER	MINIMUM	MAXIMUM	UNIT
I _{dss, Q1}	Saturated Drain Current	40	188	mA
G _{m, Q1}	Transconductance	88	212	mS
V _{p, Q1,2, 3-6, 7, 8, 9-12}	Pinch-off Voltage	-1.5	-0.5	V
V _{BVGD, Q1,2}	Breakdown Voltage Gate-Drain	-30	-8	V
V _{BVGS, Q1}	Breakdown Voltage Gate-Source	-30	-8	V

Note: Devices designated as EPU are typically early in their characterization process prior to finalizing all electrical and process specifications. Specifications are subject to change without notice

TABLE III
RF CHARACTERIZATION TABLE

(T_A = 25 °C, Nominal)
V_d = 7V, I_d = 500 mA

SYMBOL	PARAMETER	TEST CONDITION	TYPICAL LIMITS	UNITS
Gain	Small Signal Gain	F = 40-45 GHz	10	dB
IRL	Input Return Loss	F = 40-45 GHz	14.5	dB
ORL	Output Return Loss	F = 40-45 GHz	12.5	dB
P _{1dB}	Output Power @ 1dB Gain Compression	F = 40-45 GHz	29	dBm

TABLE IV
THERMAL INFORMATION*

Parameter	Test Conditions	T _{CH} (°C)	R _{θJC} (°C/W)	T _M (HRS)
R _{θJC} Thermal Resistance (channel to backside of carrier)	V _d = 7 V I _D = 500 mA P _{diss} = 3.5 W	130	17.3	5.9 E+6

Note: Assumes eutectic attach using 1.5 mil 80/20 AuSn mounted to a 20 mil CuMo Carrier at 70°C baseplate temperature. Worst case condition with no RF applied, 100% of DC power is dissipated.

Note: Devices designated as EPU are typically early in their characterization process prior to finalizing all electrical and process specifications. Specifications are subject to change without notice

Measured Fixtured Data

Bias Conditions: $V_d = 7V$, $I_d = 500mA$

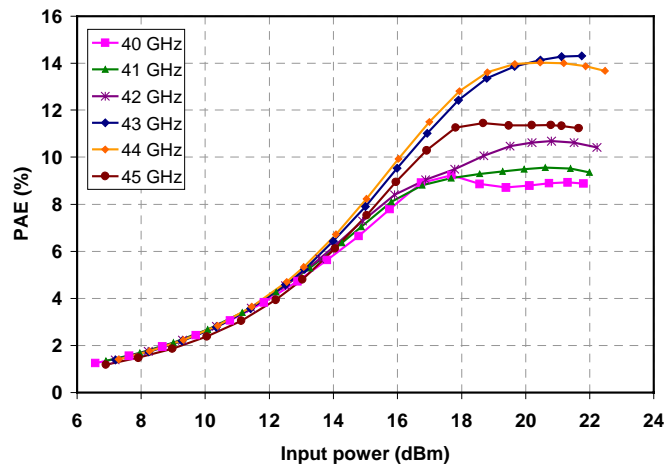
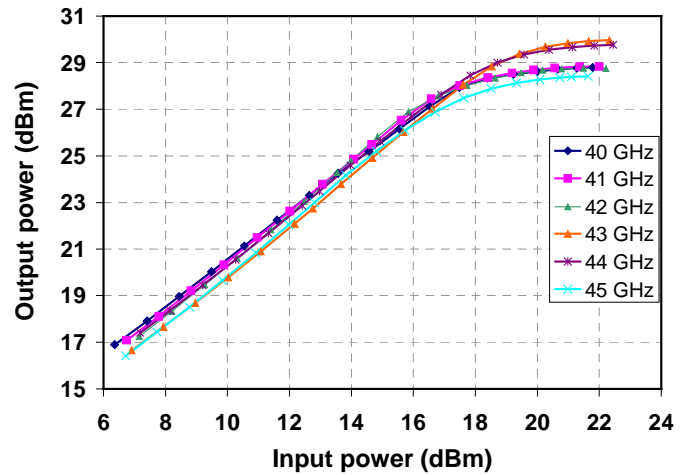
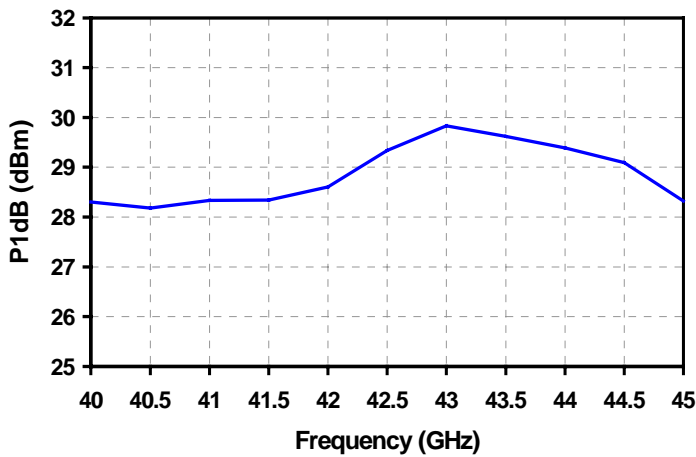
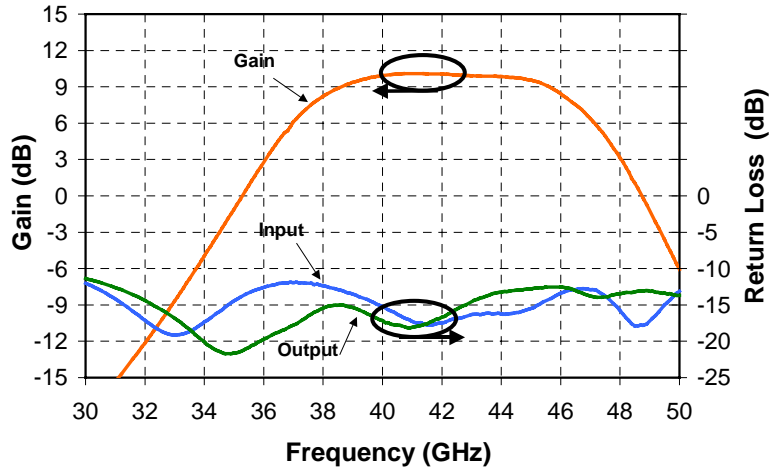

Note: Devices designated as EPU are typically early in their characterization process prior to finalizing all electrical and process specifications. Specifications are subject to change without notice

Mechanical Characteristics

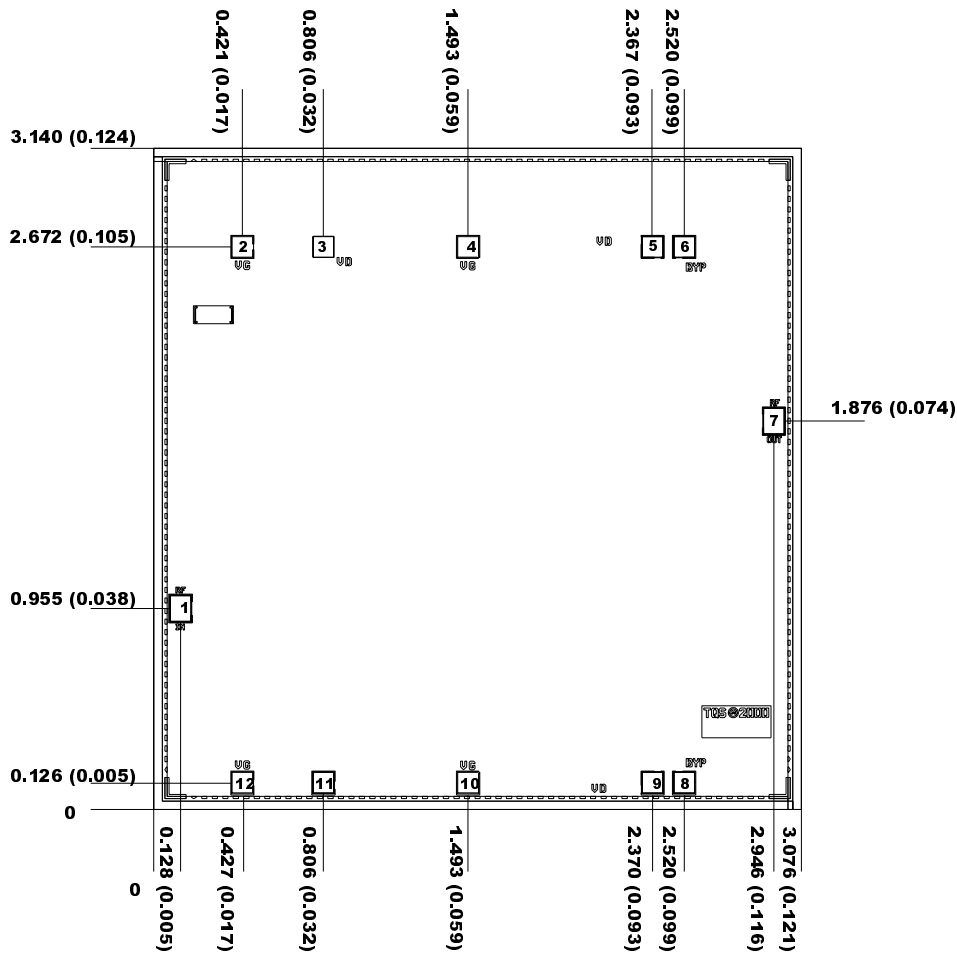

Units: millimeters (inches)

Thickness: 0.100 (0.004) (reference only)

Chip edge to bond pad dimensions are shown to center of bond pad

Chip size tolerance: +/- 0.051 (0.002)

GND IS BACKSIDE OF MMIC

Bond Pad #1 (RF Input)	0.105 x 0.130 (0.004 x 0.005)
Bond Pad #2 (Vg 1)	0.105 x 0.105 (0.004 x 0.004)
Bond Pad #3 (Vd 1)	0.105 x 0.105 (0.004 x 0.004)
Bond Pad #4 (Vg 1)	0.105 x 0.105 (0.004 x 0.004)
Bond Pad #5 (Vd 1)	0.105 x 0.105 (0.004 x 0.004)
Bond Pad #6 (Bypass)	0.105 x 0.105 (0.004 x 0.004)
Bond Pad #7 (RF Output)	0.105 x 0.130 (0.004 x 0.005)
Bond Pad #8 (Bypass)	0.105 x 0.130 (0.004 x 0.005)
Bond Pad #9 (Vd 2)	0.105 x 0.105 (0.004 x 0.004)
Bond Pad #10 (Vg 2)	0.105 x 0.105 (0.004 x 0.004)
Bond Pad #11 (Vd #2)	0.105 x 0.105 (0.004 x 0.004)
Bond Pad #12 (Vg #2)	0.105 x 0.105 (0.004 x 0.004)

GaAs MMIC devices are susceptible to damage from Electrostatic Discharge. Proper precautions should be observed during handling, assembly and test.

Note: Devices designated as EPU are typically early in their characterization process prior to finalizing all electrical and process specifications. Specifications are subject to change without notice

Recommended Assembly Diagram

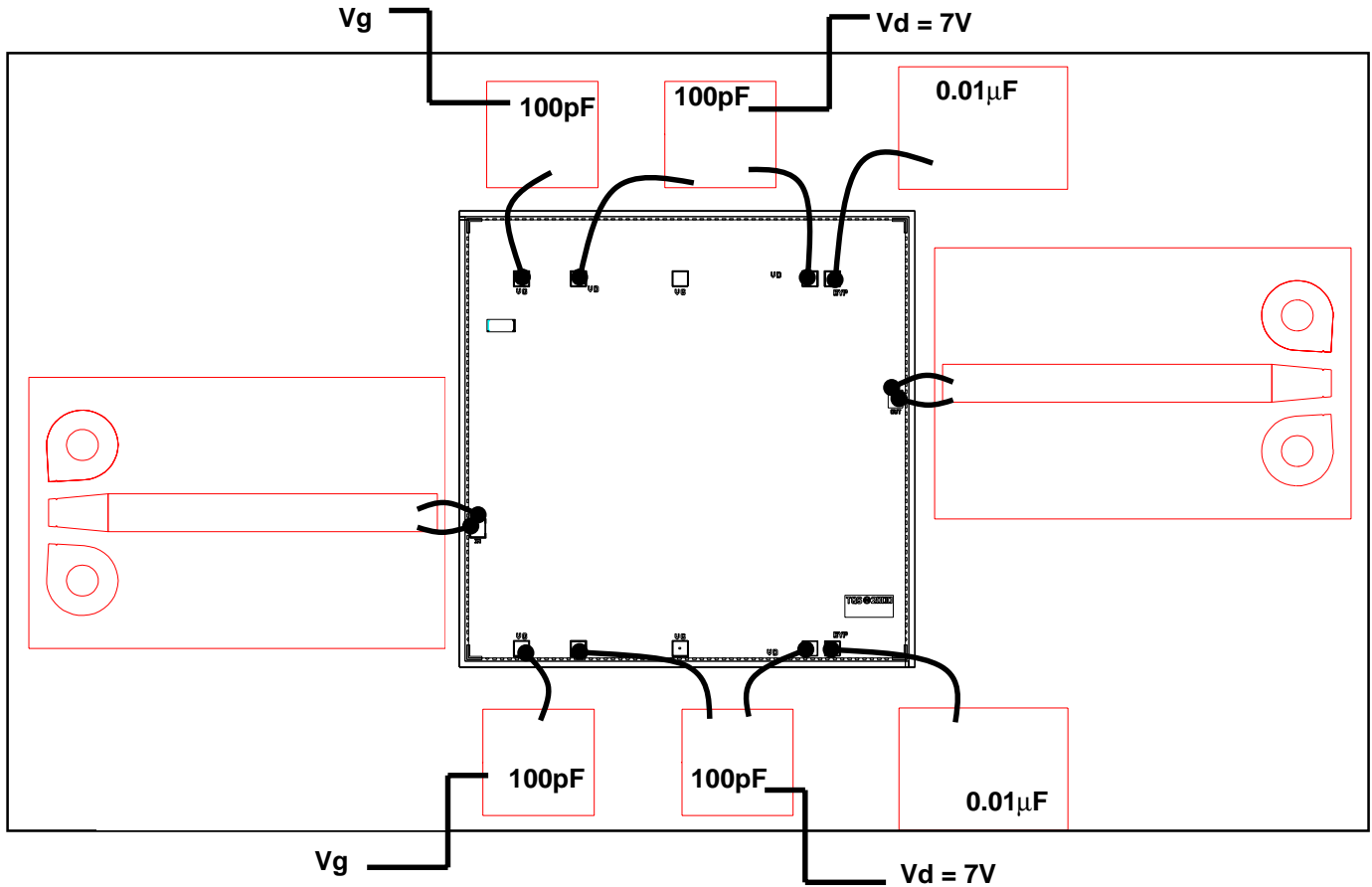

Note:

We recommend 1µF caps on the bias lines to suppress possible low frequency oscillations.

GaAs MMIC devices are susceptible to damage from Electrostatic Discharge. Proper precautions should be observed during handling, assembly and test.

Note: Devices designated as EPU are typically early in their characterization process prior to finalizing all electrical and process specifications. Specifications are subject to change without notice

Assembly Process Notes

Reflow process assembly notes:

- Use AuSn (80/20) solder with limited exposure to temperatures at or above 300 °C for 30 sec
- An alloy station or conveyor furnace with reducing atmosphere should be used.
- No fluxes should be utilized.
- Coefficient of thermal expansion matching is critical for long-term reliability.
- Devices must be stored in a dry nitrogen atmosphere.

Component placement and adhesive attachment assembly notes:

- Vacuum pencils and/or vacuum collets are the preferred method of pick up.
- Air bridges must be avoided during placement.
- The force impact is critical during auto placement.
- Organic attachment can be used in low-power applications.
- Curing should be done in a convection oven; proper exhaust is a safety concern.
- Microwave or radiant curing should not be used because of differential heating.
- Coefficient of thermal expansion matching is critical.

Interconnect process assembly notes:

- Thermosonic ball bonding is the preferred interconnect technique.
- Force, time, and ultrasonics are critical parameters.
- Aluminum wire should not be used.
- Devices with small pad sizes should be bonded with 0.0007-inch wire.
- Maximum stage temperature is 200 °C.

GaAs MMIC devices are susceptible to damage from Electrostatic Discharge. Proper precautions should be observed during handling, assembly and test.

Note: Devices designated as EPU are typically early in their characterization process prior to finalizing all electrical and process specifications. Specifications are subject to change without notice