

July 18, 2000

TEL:805-498-2111 FAX:805-498-3804 WEB:http://www.semtech.com

DESCRIPTION

USB power distribution switches are high-side N-channel MOSFET switches with built-in overcurrent protection and low on-state resistance. The SC2041 switch is designed to meet the USB requirements for power switching and maintenance-free fault protection for self-powered & bus-powered hub applications. The SC2041 features low on-state resistance to meet the USB requirement for voltage drop and regulation. The switch is controlled by a shutdown input that is compatible with 3V and 5V logic. The device is active when the shutdown input is low. See SC2051 for an active high version. The device provides short circuit current limiting at a value of less than 1.0A, well below the USB limit of 5A. During an overcurrent condition the device provides a fault notification to signal the USB controller. An integrated thermal protection circuit automatically shuts the switch off when the junction temperature reaches its thermal limit. The switch remains off until the junction temperature drops approximately 20°C. The switch will continue to cycle on and off until the fault is removed. Inrush current limiting prevents voltage drop on an upstream port when the switch is enabled. An undervoltage lockout circuit guarantees the switch is initially off during start-up.

FEATURES

- Designed to meet USB specification revisions 1.1 and 2.0 power management requirements
- 500mA continuous load current
- High-side MOSFET switch with low $R_{DS(ON)}$
- Short-circuit current protection
- Internal thermal shutdown
- Undervoltage lockout
- Open drain fault output
- Soft start circuit with slow turn-on time
- Wide supply voltage range: 2.8V to 5.5V
- 2.5kV ESD rating (Human Body Model)
- Full industrial temperature range

APPLICATIONS

- Universal Serial Bus (USB) power management
- Self-powered or bus-powered USB hubs
- Root hubs in desktop PCs & servers
- Notebook PCs
- Peripherals

ORDERING INFORMATION

DEVICE ⁽¹⁾	PACKAGE
SC2041IS.TR	SO-8

Note:

(1) Only available in tape and reel packaging. A reel contains 2500 devices.

TYPICAL APPLICATION CIRCUIT

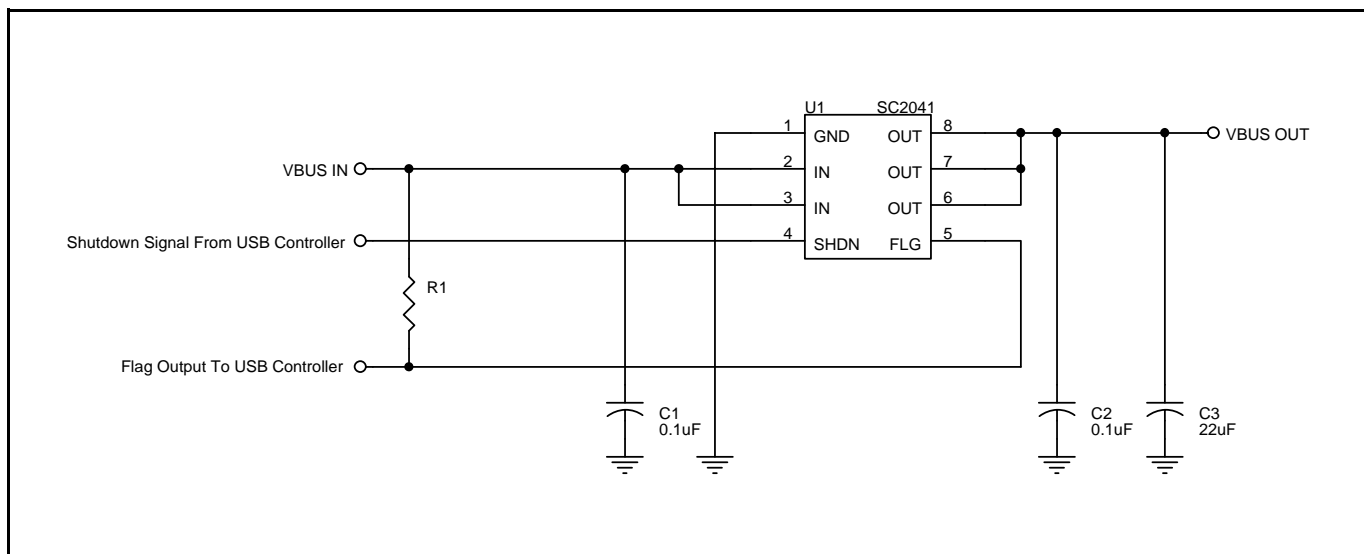

July 18, 2000

ABSOLUTE MAXIMUM RATINGS

Parameter	Symbol	Maximum	Units
Input Voltage Range	V_{IN}	-0.3 to +7	V
Output Voltage Range	V_{OUT}	-0.3 to +7	V
Shutdown Input	V_{EN}	-0.3 to +7	V
Flag Output	V_{FLG}	-0.3 to ($V_{IN} + 0.3$)	V
Continuous Output Current	I_O	Internally Limited	mA
Thermal Impedance Junction to Ambient	θ_{JA}	130	°C/W
Thermal Impedance Junction to Case	θ_{JC}	47	°C/W
Operating Ambient Temperature Range	T_A	-40 to +85	°C
Operating Junction Temperature Range	T_J	-40 to +125	°C
Storage Temperature Range	T_{STG}	-65 to +150	°C
Lead Temperature (Soldering, 10 seconds)	T_L	300	°C
ESD Rating (Human Body Model)	ESD	2.5	kV

ELECTRICAL CHARACTERISTICS

 Unless specified: $T_A = 25^\circ\text{C}$, $V_{IN} = 5\text{V}$, $V_{SHDN} = \text{GND}$, $I_{OUT} = 500\text{mA}$. Values in **bold** apply over the full operating temperature range.

Parameter	Symbol	Conditions	Min	Typ	Max	Units
IN						
Supply Voltage Range	V_{IN}		2.8		5.5	V
Supply Current	I_Q	$V_{IN} = 3.3\text{V}$		85	130	μA
				200		
		$V_{IN} = 5.0\text{V}$		100	130	μA
				200		
		$V_{SHDN} = V_{IN} = 5.5\text{V (OFF)}$		0.1	1	μA
Power Switch						
On Resistance	r_{ON}	$V_{IN} = 3.3\text{V}$		85	105	m Ω
					150	
		$V_{IN} = 5.0\text{V}$		80	100	
					135	
OUT						
Output Leakage Current	$I_{L(OFF)}$	$V_{IN} = V_{SHDN} = 5.5\text{V}$, $V_{OUT} = \text{GND}$		0.01	1	μA
Output Turn On Delay	$t_{d(ON)}$	$R_{OUT} = 10\Omega$, $C_{OUT} = 1\mu\text{F}$		0.9		ms
Output Turn On Rise Time	t_r	$R_{OUT} = 10\Omega$, $C_{OUT} = 1\mu\text{F}$		1.7		ms
Output Turn Off Delay	$t_{d(OFF)}$	$R_{OUT} = 10\Omega$, $C_{OUT} = 1\mu\text{F}$		20		μs
Output Turn Off Fall Time	t_f	$R_{OUT} = 10\Omega$, $C_{OUT} = 1\mu\text{F}$		25		μs

July 18, 2000

ELECTRICAL CHARACTERISTICS (Cont.)

 Unless specified: $T_A = 25^\circ\text{C}$, $V_{IN} = 5\text{V}$, $V_{SHDN} = \text{GND}$, $I_{OUT} = 500\text{mA}$. Values in **bold** apply over the full operating temperature range.

Parameter	Symbol	Conditions	Min	Typ	Max	Units
Current Limit						
Short Circuit Current Limit	I_{CL}	$V_{OUT} = \text{GND}$	0.60	0.85	1.10	A
Current Limit Trip Threshold	$I_{TH(CL)}$			1.5		A
SHDN						
High Level Input Voltage	V_{IH}	$2.8\text{V} \leq V_{IN} \leq 5.50\text{V}$	2.4			V
Low Level Input Voltage	V_{IL}	$2.8\text{V} \leq V_{IN} \leq 5.50\text{V}$			0.8	V
Input Current	I_{SHDN}	$V_{SHDN} = V_{IN} = 5.5\text{V}$, $V_{OUT} = \text{OPEN}$			1	μA
		$V_{SHDN} = \text{GND}$, $I_{OUT} = 0\text{mA}$, $V_{OUT} = \text{OPEN}$			1	
Undervoltage Lockout						
UVLO Threshold	V_{UVLO}	V_{IN} rising		2.7		V
		V_{IN} falling		2.4		V
FLG						
Output Resistance	r_{FLG}	$I_{FLG} = 10\text{mA}$, $V_O = \text{GND}$, Switch ON			50	Ω
Leakage Current (OFF)	I_{FLG}	$V_{FLG} = 5.0\text{V}$, Switch OFF			1	μA
Over Temperature Protection						
High Trip Level	T_{HI}			150		$^\circ\text{C}$
Hysteresis	T_{HYST}			20		$^\circ\text{C}$

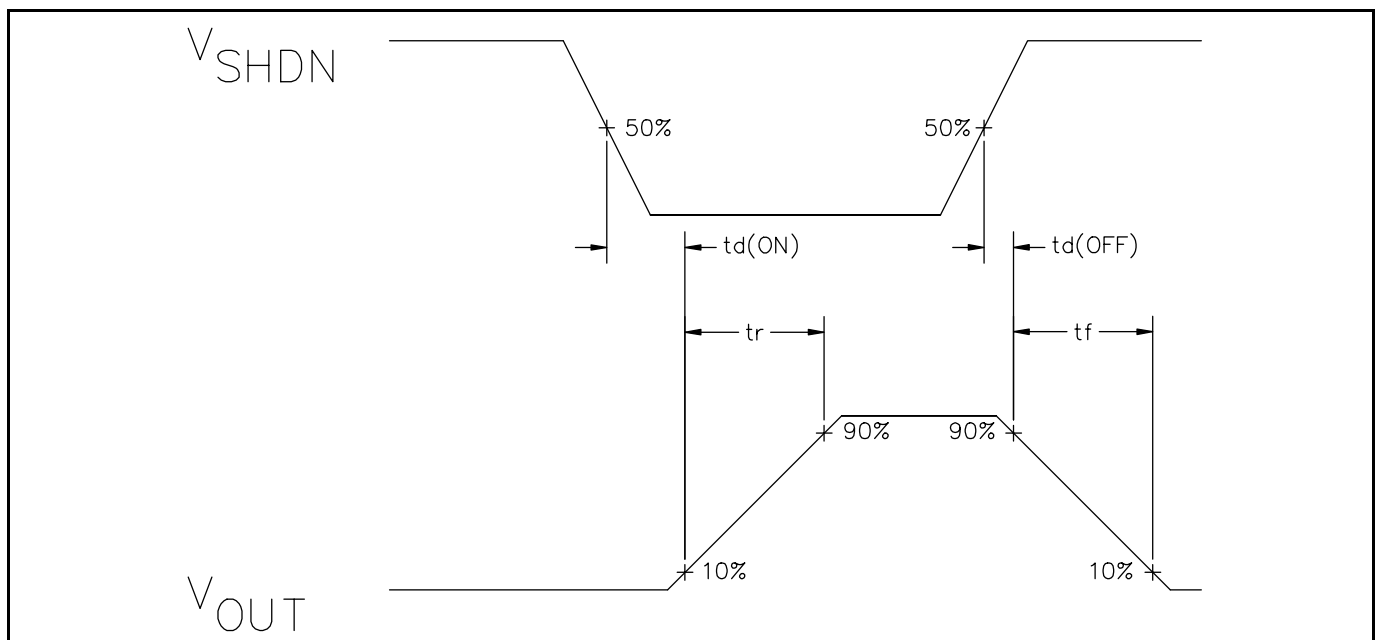
TIMING DIAGRAM: OUTPUT TURN ON/OFF DELAY TIMES AND RISE/FALL TIMES

July 18, 2000

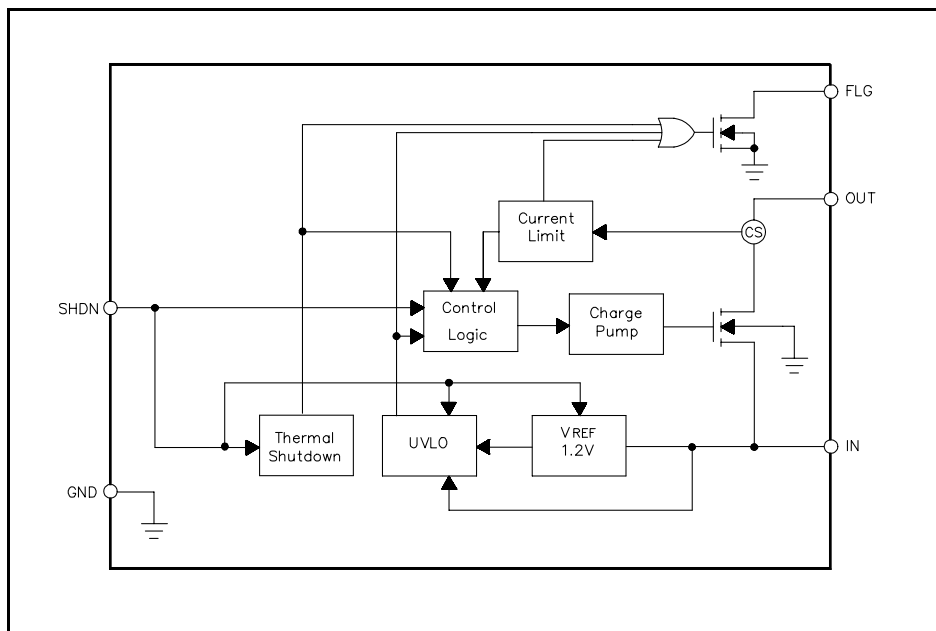
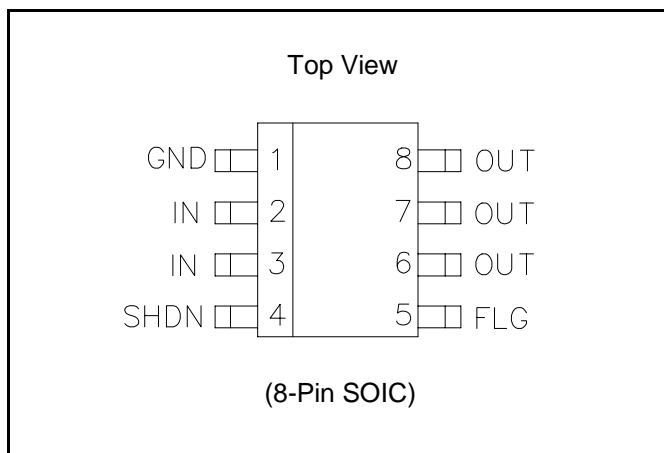
BLOCK DIAGRAM

PIN CONFIGURATION

PIN DESCRIPTION

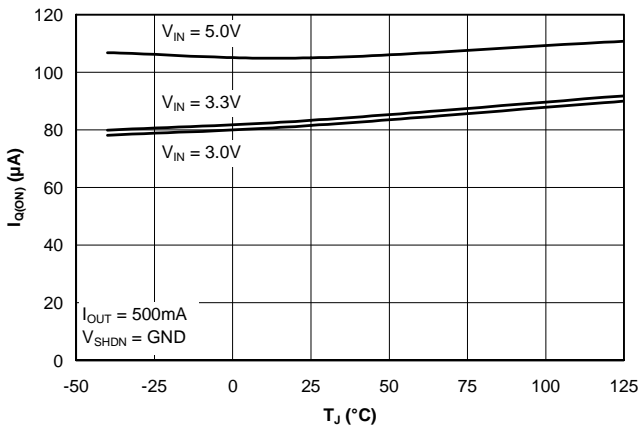
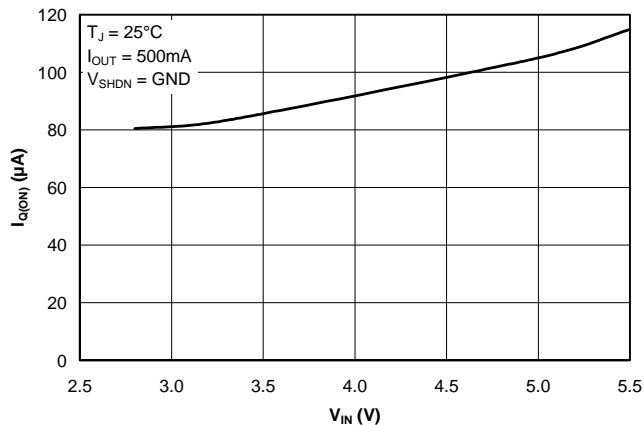
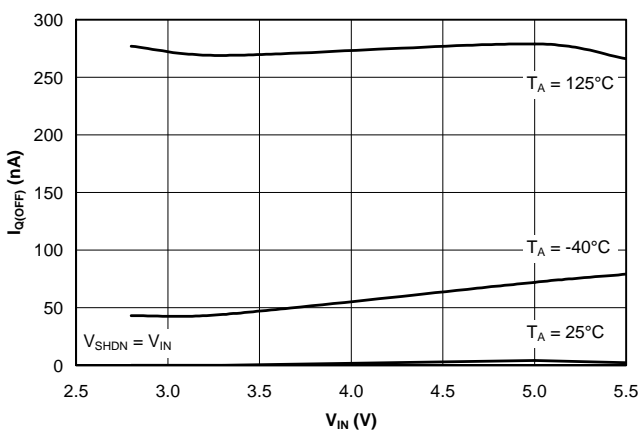
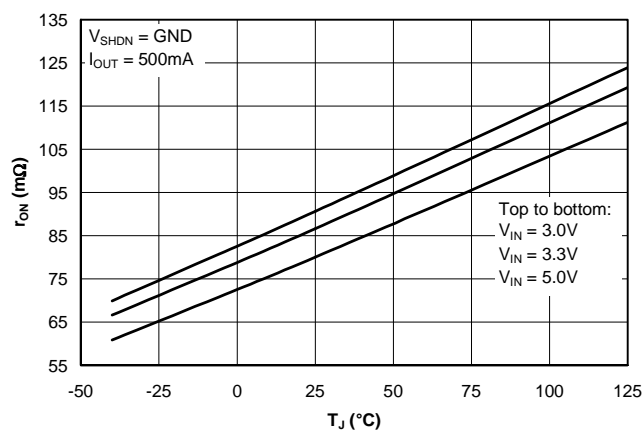
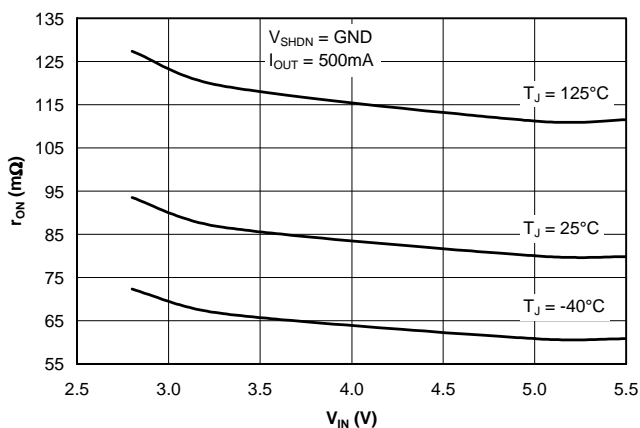
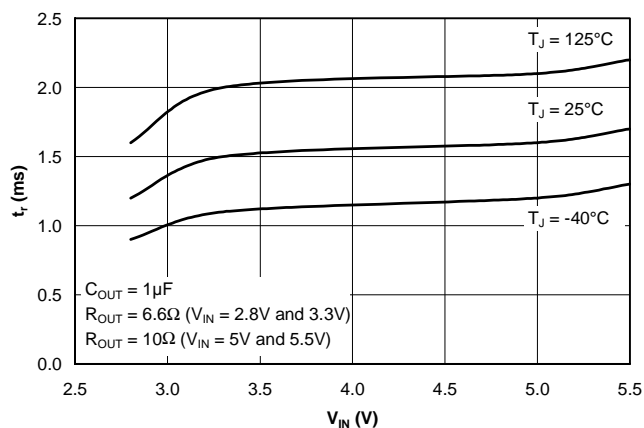
Pin #	Pin Name	Pin Function
1	GND	Ground.
2, 3	IN	Input voltage: drain of N-channel power MOSFET. Connect to supply voltage.
4	SHDN	Shutdown input: TTL compatible. N-channel power MOSFET is turned on when this pin is pulled low.
5	FLG	Error flag output: FLG is asserted active low during a fault condition (overcurrent, input undervoltage or thermal shutdown).
6, 7, 8	OUT	Power switch output: source of N-channel power MOSFET. Connect to load.

July 18, 2000

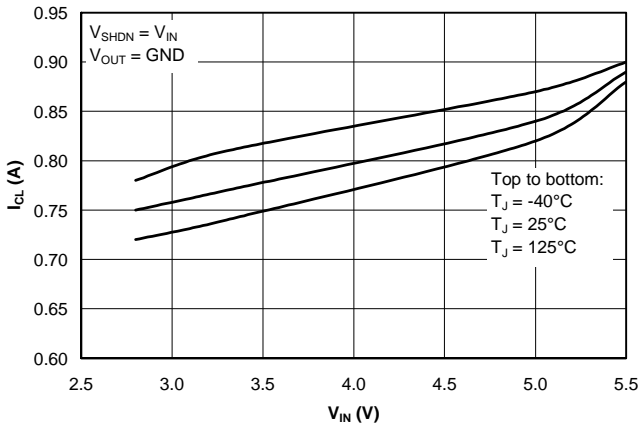
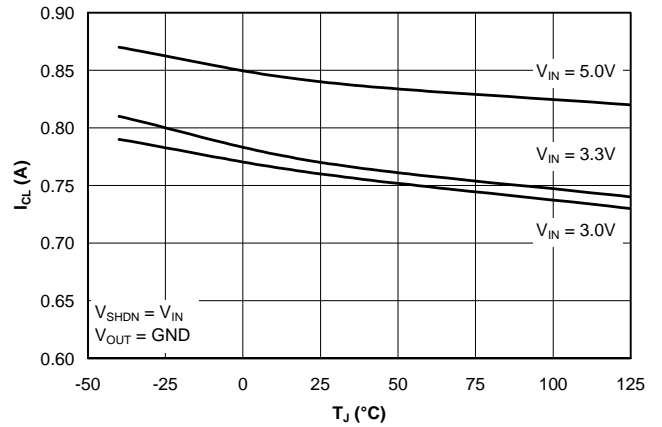
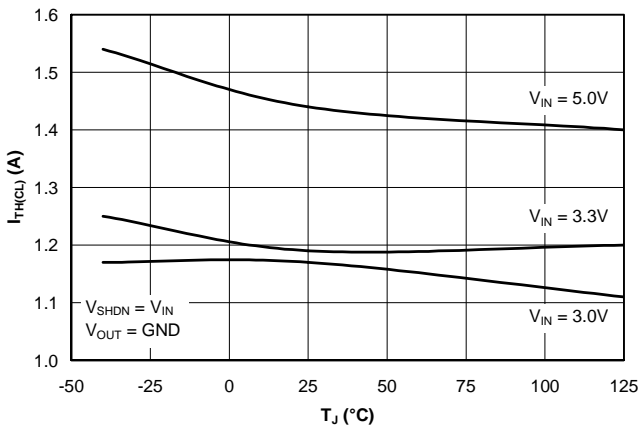
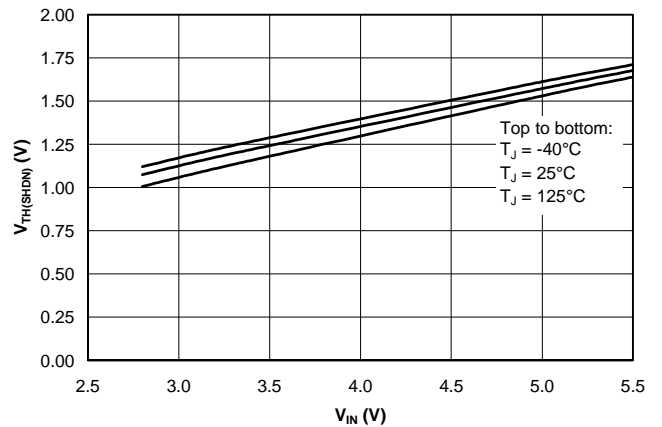
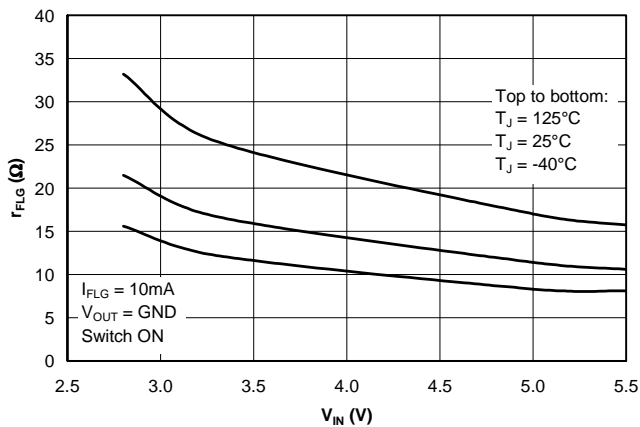
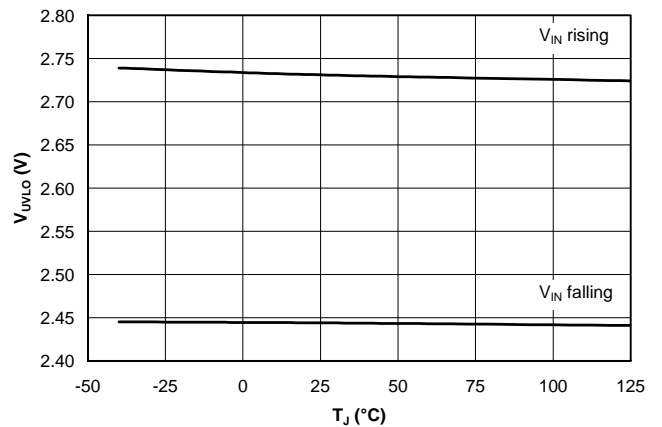
TYPICAL CHARACTERISTICS
On-State Quiescent Current vs. Junction Temperature vs. Input Voltage

On-State Quiescent Current vs. Input Voltage

Off-State Quiescent Current vs. Input Voltage vs. Junction Temperature

Power Switch On Resistance vs. Junction Temperature vs. Input Voltage

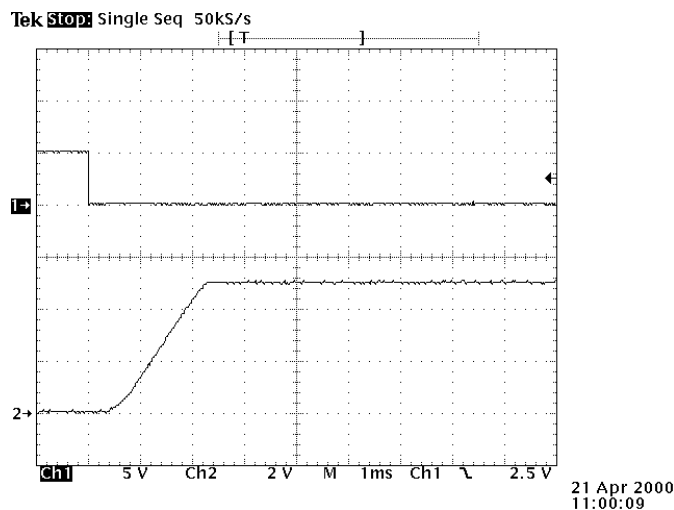
Power Switch On Resistance vs. Input Voltage vs. Junction Temperature

Output Turn-On Rise Time vs. Input Voltage vs. Junction Temperature

July 18, 2000

TYPICAL CHARACTERISTICS (Cont.)
Short Circuit Current Limit vs. Input Voltage vs. Junction Temperature

Short Circuit Current Limit vs. Junction Temperature vs. Input Voltage

Current Limit Trip Threshold vs. Junction Temperature vs. Input Voltage

Shutdown Threshold vs. Input Voltage vs. Junction Temperature

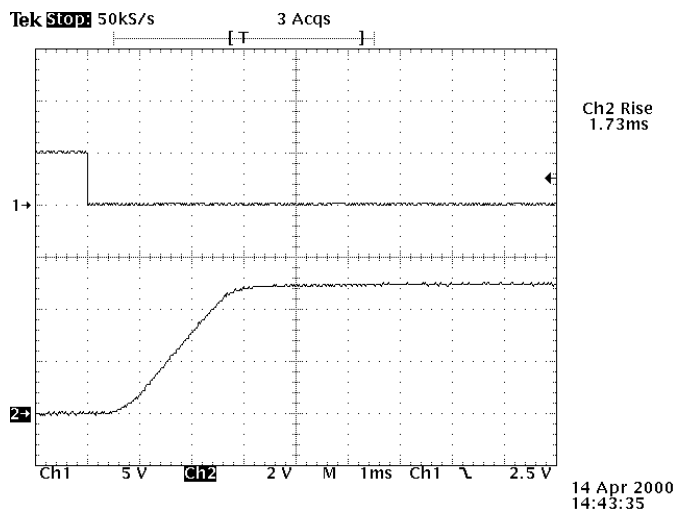
Error Flag Output Resistance vs. Input Voltage vs. Junction Temperature

Undervoltage Lockout vs. Junction Temperature

July 18, 2000

TYPICAL CHARACTERISTICS (Cont.)
Figure 1: Output Turn On Delay and Rise Time with 0.1 μ F Output Capacitor and No Load

Top Trace: V_{SHDN} , 5V/div.
 Bottom Trace: V_{OUT} , 2V/div.
 Timebase: 1ms/div.
 $V_{IN} = 5V$, $R_{OUT} = \text{open}$, $C_{OUT} = 0.1\mu F$

Figure 2: Output Turn On Delay and Rise Time with 1 μ F Output Capacitor and 10 Ω Load

Top Trace: V_{SHDN} , 5V/div.
 Bottom Trace: V_{OUT} , 2V/div.
 Timebase: 1ms/div.
 $V_{IN} = 5V$, $R_{OUT} = 10\Omega$, $C_{OUT} = 1\mu F$

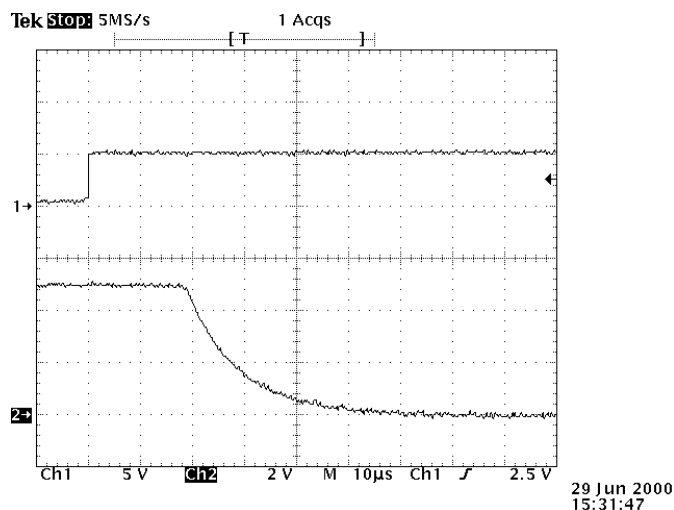
Figure 3: Output Turn Off Delay and Fall Time with 1 μ F Output Capacitor and 10 Ω Load

Top Trace: V_{OUT} , 5V/div.
 Bottom Trace: I_{OUT} , 0.5A/div.
 Timebase: 100ms/div.
 $V_{IN} = 5V$, R_{OUT} ramping from open to 1.1 Ω , $C_{OUT} = 22\mu F$

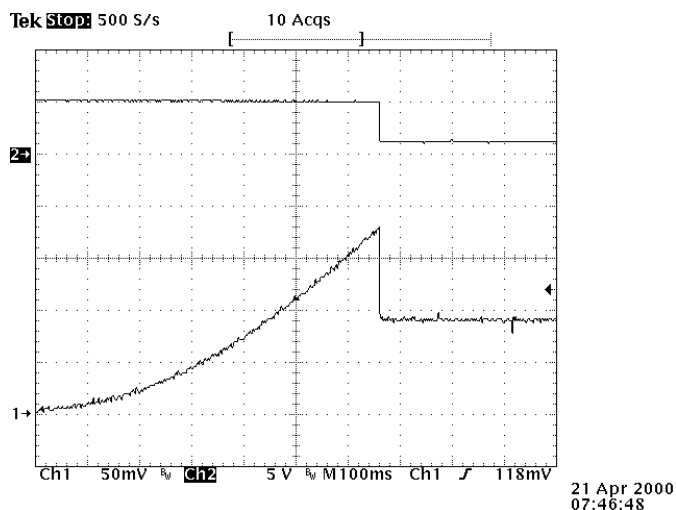
Figure 4: Current Limit and Trip Threshold With Ramped Load on Enabled Device

Top Trace: V_{OUT} , 5V/div.
 Bottom Trace: I_{OUT} , 0.5A/div.
 Timebase: 100ms/div.
 $V_{IN} = 5V$, R_{OUT} ramping from open to 1.1 Ω , $C_{OUT} = 22\mu F$

July 18, 2000

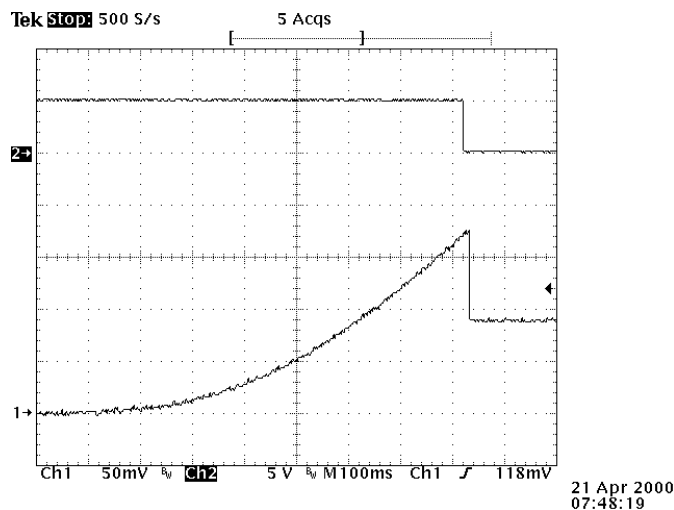
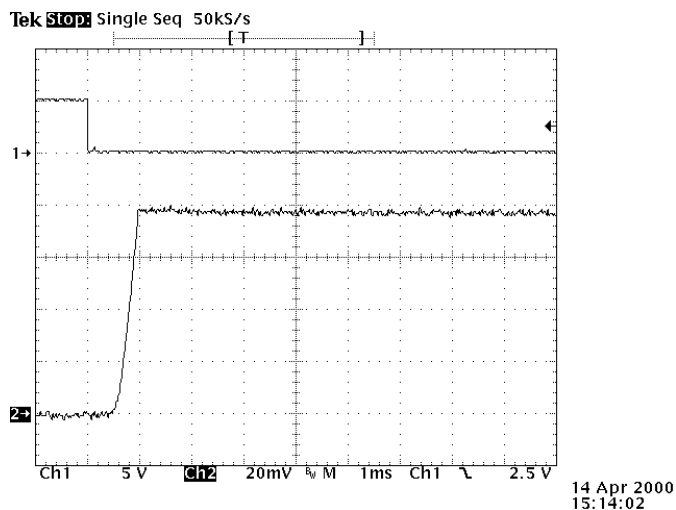
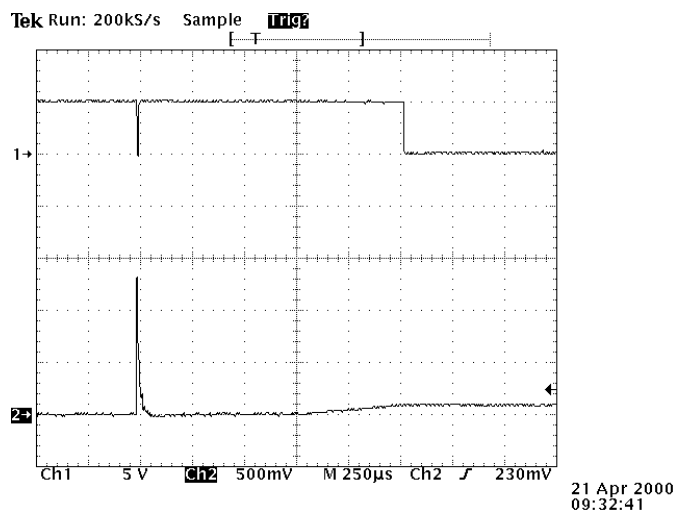
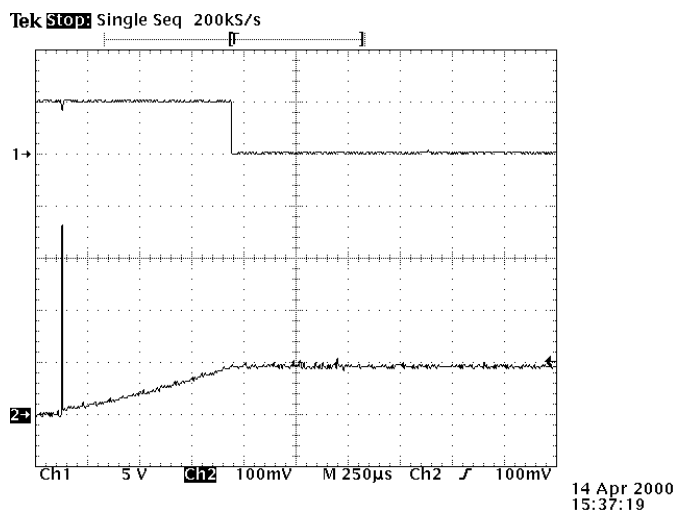
TYPICAL CHARACTERISTICS (Cont.)
Figure 5: Current Limit and Trip Threshold With Ramped Load on Enabled Device

Figure 6: Short Circuit Current, Device Enabled Into Short

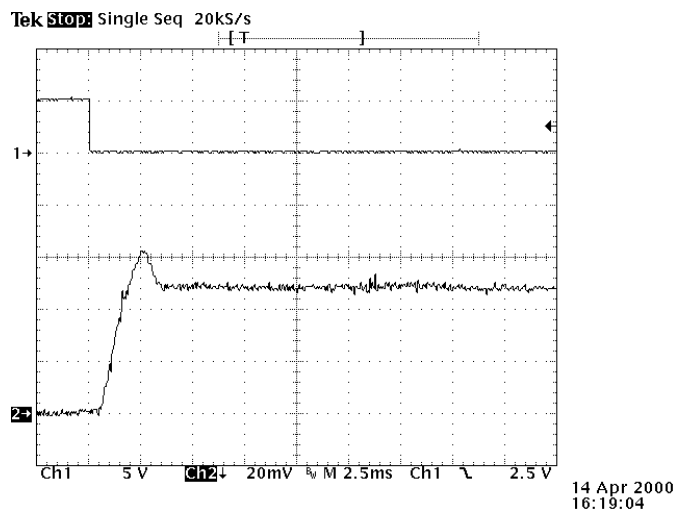
Figure 7: Short Circuit Current, Short Applied to Enabled Device

Figure 8: Current Limit, 1.1Ω Load Applied to Enabled Device

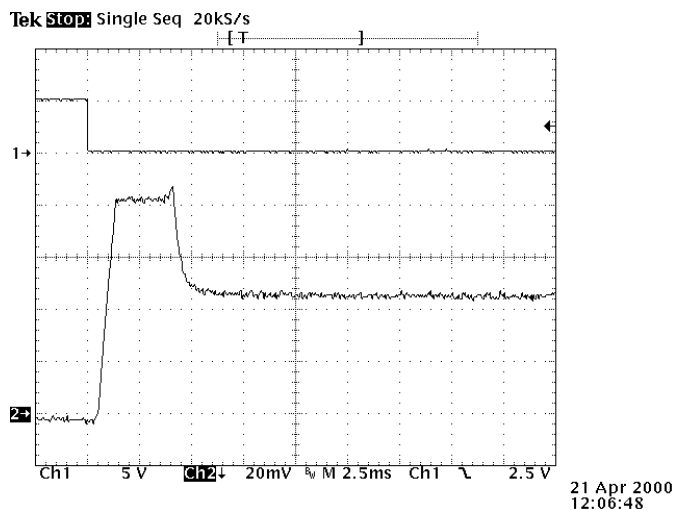
July 18, 2000

TYPICAL CHARACTERISTICS (Cont.)
Figure 9: Inrush Current, Device Enabled Into 100 μ F and 10 Ω

Top Trace: V_{SHDN} , 5V/div.
 Bottom Trace: I_{OUT} , 0.2A/div.
 Timebase: 2.5ms/div.
 $V_{IN} = 5V$, $R_{OUT} = 10\Omega$, $C_{OUT} = 100\mu F$

Figure 10: Inrush Current, Device Enabled Into 470 μ F and 10 Ω

Top Trace: V_{SHDN} , 5V/div.
 Bottom Trace: I_{OUT} , 0.2A/div.
 Timebase: 2.5ms/div.
 $V_{IN} = 5V$, $R_{OUT} = 10\Omega$, $C_{OUT} = 470\mu F$

APPLICATIONS INFORMATION
Theory Of Operation

The SC2041 is a current limited 80m Ω power switch with error reporting and enable features. The power switch is an N-channel MOSFET with its gate driven by an internal charge pump. The switch has been designed to turn on slowly (1.7ms typical) to minimize inrush currents at turn-on.

The Shutdown pin (SHDN) is compatible with 3V or 5V logic, and when pulled high, shuts off the power switch, causing the device to enter a very low power shutdown mode, where it will draw less than 1 μ A from the supply. While enabled, the SC2041 draws only 100 μ A from the supply.

The power switch has current limit detection circuitry which will limit the current through the switch to 0.85A (typical) and reduce the output voltage accordingly. When current limit is entered, the open drain Flag pin (FLG) is asserted low, indicating a fault condition. If an overcurrent or short condition is continuous, the power dissipation in the switch will cause the junction temperature to rise, triggering the thermal protection circuitry

to shut the switch down (at $T_J = 150^\circ C$ typical). This will shut off the output current altogether, and also cause the Flag pin to be asserted low. Once the junction temperature has dropped by 20 $^\circ C$ (typical), the device will start up once more in a controlled manner.

The SC2041 will operate from supply voltages as low as 2.8V, and internal undervoltage lockout circuitry ensures that the power switch will be turned off at power-up, even if the device is enabled. Once the UVLO threshold voltage (2.7V typical) is reached, the switch will turn on (if enabled) and slowly ramp up the output.

The SC2041 has been designed for use in USB applications such as:

- 1) hosts or self-powered hubs that need to current limit downstream ports and report overcurrent conditions;
- 2) bus-powered hubs that need to be able to switch power to downstream ports, limit inrush currents at power-up (to less than a 44 Ω resistor in parallel with a 10 μ F capacitor) and power-up and draw less than 100mA;
- 3) bus-powered functions that need to limit inrush currents at power-up (to less than a 44 Ω resistor in parallel with a 10 μ F capacitor) and power-up and draw less than 100mA.

July 18, 2000

APPLICATIONS INFORMATION (Cont.)

Component Selection - General

A 0.1μF or greater ceramic bypass capacitor is recommended at the device input. This should be placed

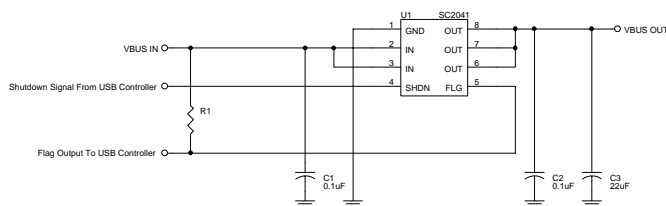

close to the input pin (IN) and routed directly to ground. A low ESR electrolytic capacitor is recommended at the output, higher values should be used for heavy loads to reduce ringing at the output (and hence input). Bypass the output with a 0.1μF to 1μF ceramic capacitor to improve immunity to short circuit transients.

Shutdown

The shutdown pin (SHDN) input is a 3V or 5V compatible enable/disable. Pulling this pin high shuts down the power switch and the SC2041 will draw < 1μA from the supply. Pulling this pin low will enable the device.

Error Flag

The error flag (FLG) output is an open drain N-channel MOSFET. Its output is pulled low during overcurrent, input undervoltage and thermal shutdown conditions. Connection of high capacitance loads to the output can cause momentary overcurrent conditions due to inrush current and trigger false error flag assertion. This can be reduced by using low ESR output capacitors to provide a low impedance source for hot-plug events. The addition of an RC filter between FLG and the USB controller can resolve this easily. This pin also requires a pull-up resistor for a high signal when not asserted.

Overcurrent

There are three overcurrent situations to be considered:

1) the output is already short before the device is enabled or power is applied. In this case, the SC2041 immediately detects the short, and the output current will slowly ramp up to the current limit value, and FLG will assert low. Refer to Figure 6 on page 8.

2) a short occurs while the device is enabled. In this case, very high current may flow initially while the

overcurrent circuitry reacts. Once the current limit circuitry trips, the current is limited to 0.85A and FLG is asserted low. Refer to Figure 7 on page 8.

3) the load gradually increases beyond 500mA. In this case, the current will be allowed to rise until it reaches the Current Limit Trip Threshold, at which point the current will drop back to 0.85A and FLG will assert low. Refer to figures 4 and 5 on page 7 and 8.

Thermal Sensing

An internal thermal shutdown circuit turns off the power switch when the die temperature exceeds 150°C (typical). The FLG pin asserts low signaling a fault condition. Built-in hysteresis prevents the switch from turning back on until the die temperature has cooled approximately 20°C. The switch will continue to cycle on and off until the fault condition is removed. The thermal sense circuit functions only when the switch is enabled.

Undervoltage Lockout

An undervoltage lockout circuit monitors the input voltage and prevents the power switch from turning on until the input voltage (IN) exceeds 2.7V (typical). If the input voltage falls and drops below 2.4V (typical), the undervoltage circuitry turns off the power switch and the FLG pin asserts low. The undervoltage lockout functions only when the switch is enabled.

Thermal Considerations

Since the on-resistance of the power switch is so low, the SC2041 can pass large currents without requiring a large package to dissipate the heat. The worst-case power dissipation (under normal operating conditions) is given by:

$$P_{D(MAX)} = (I_{OUT})^2 \cdot r_{ON(MAX)}$$

So for $I_{OUT} = 500\text{mA}$ and $r_{ON(MAX)} = 150\text{m}\Omega$ (at $V_{IN} = 3.3\text{V}$), the maximum power dissipation is:

$$P_{D(MAX)} = (0.5)^2 \cdot 0.150 = 37.5\text{mW}$$

The junction temperature can be calculated using the following equation:

$$T_J = T_A + \theta_{JA} \cdot P_{D(MAX)}$$

Inserting $T_A = 85^\circ\text{C}$, $\theta_{JA} = 130^\circ\text{C/W}$ (package thermal impedance for minimum line widths and no internal

July 18, 2000

TYPICAL APPLICATIONS CIRCUITS (Cont.)
High-Power or Low-Power Bus-Powered Function:

Both low-power and high-power bus-powered functions must draw less than 100mA at startup. At this time, they must also present a load of less than the parallel combination of a 44Ω resistor and a 10μF capacitor. After startup, high powered functions may then draw up to 500mA. The circuit below utilizes the SC2041 to provide inrush current limiting and power switching for the internal function.

Since USB is a hot insertion and removal system, USB ports are subject to electrostatic discharge (ESD). The SR05 provides ESD protection on the upstream data and power lines. With proper layout the port is hardened to greater than 15kV, meeting the requirements of IEC 1000-4-2. The SC5205 LDO regulator is used to power the hub controller from the upstream bus. The SC2041 is used to power the hub controller from the upstream bus.

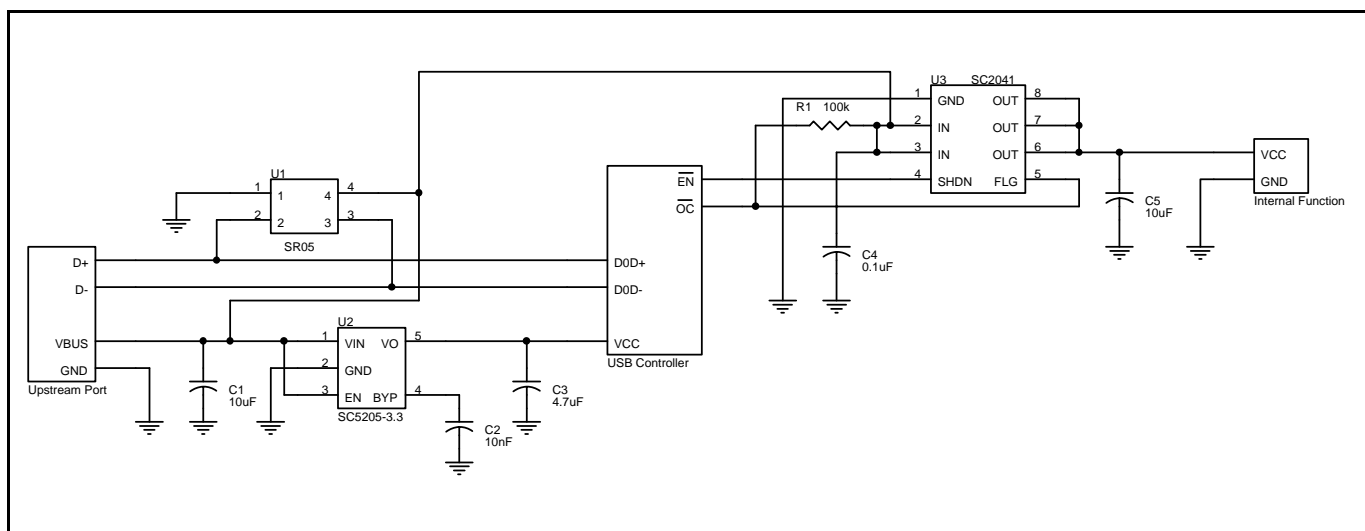
Note:

(1) 33μF output capacitor per port meets the USB specification minimum capacitance of 120μF per hub.

July 18, 2000

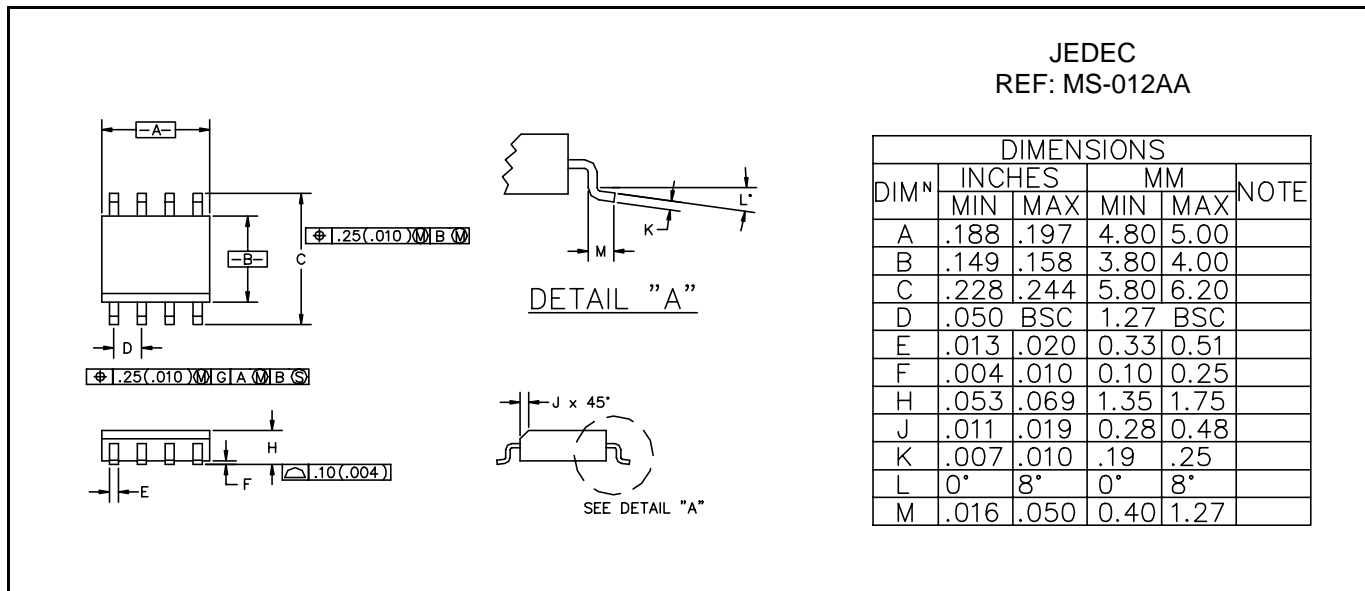
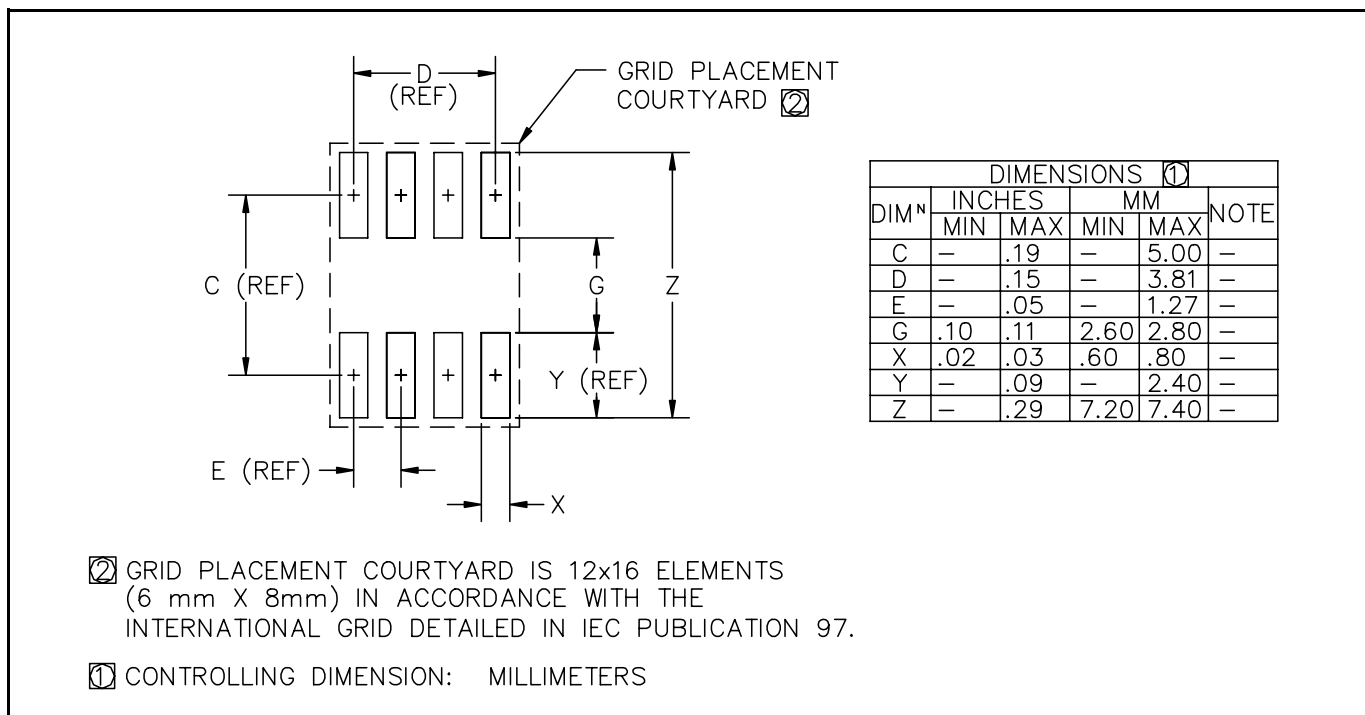
OUTLINE DRAWING - SO-8

LAND PATTERN - SO-8

ECN00-1199