

Model EN12
 12mm Rotary Encoder
 2 Bits Gray Code
 Incremental/Contacting Type
 Metal Bushing/Plastic Shaft
 Push-on Switch Option
 RoHS Compliant

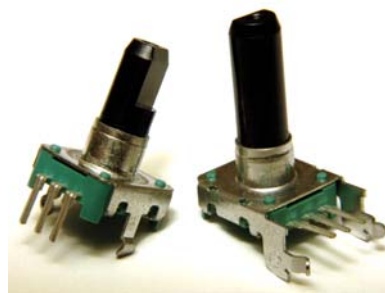

MODEL STYLES

Top Adjust, with Switch	EN12-HS
Top Adjust, without Switch	EN12-HN
Side Adjust, with Switch	EN12-VS
Side Adjust, without Switch	EN12-VN

ELECTRICAL¹

Pulses (Per Revolution)	12 & 24
Closed Circuit Resistance, Ohms	3 Ohms, max.
Contact Rating	1mA/ 5Vdc
Operating Current, Maximum	1mA
Dielectric Strength	300Vac/ 1mA, 1 minute
Insulation Resistance, Minimum	100M ohms at 250Vdc/ 1mA
Sliding Noise (at 60 RPM)	2.0ms max.
Contact Bounce (at 15 RPM)	5.0ms max.
Operating Speed (RPM)	100 RPM max.
Switch Power Rating	10mA/ 5Vdc
Switch Contact Resistance	100 milliohms
Actual Electrical Travel, Nominal	Continuous

MECHANICAL

Total Mechanical Travel	Continuous
Detents (per Revolution)	0, 12, 24
Rotational Torque of Detent, Maximum	1.4 oz-in
Switch Operating Force	550 gf
Switch Travel	0.5mm

¹ Specifications subject to change without notice.

Model EN12

ENVIRONMENTAL

Operating Temperature Range

-30°C to +85°C

Rotational Life

30,000 cycles

ORDERING INFORMATION²

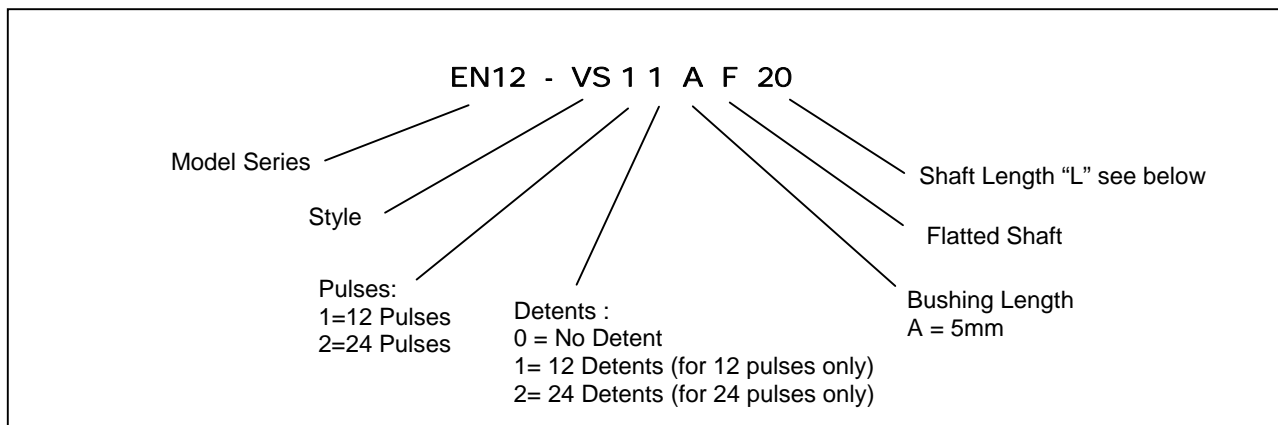

Shaft Length Options

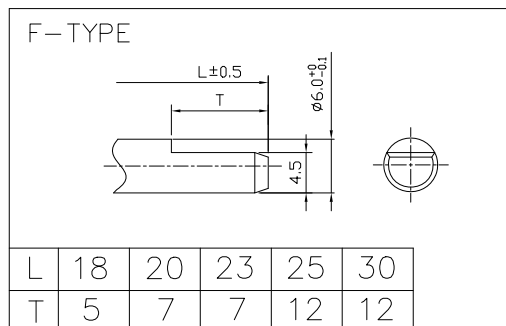

18 Length = 17.5mm

23 Length = 22.5mm

CIRCUIT DIAGRAM

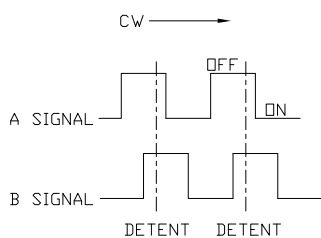

² Contact our customer service for custom designs and features.

Model EN12

OUTLINE DRAWING

EN12-HS (Top Adjust, with Switch)

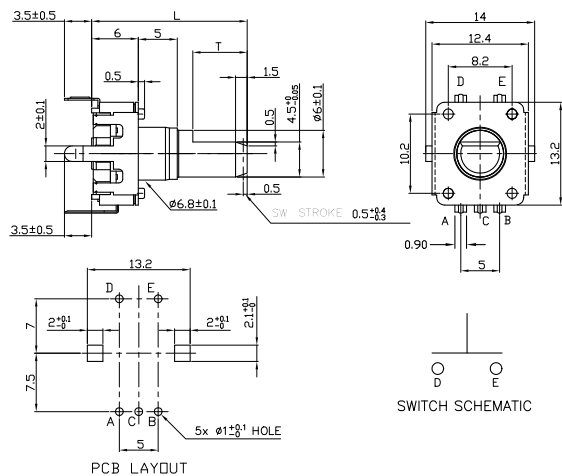

EN12-HN (Top Adjust, without Switch)

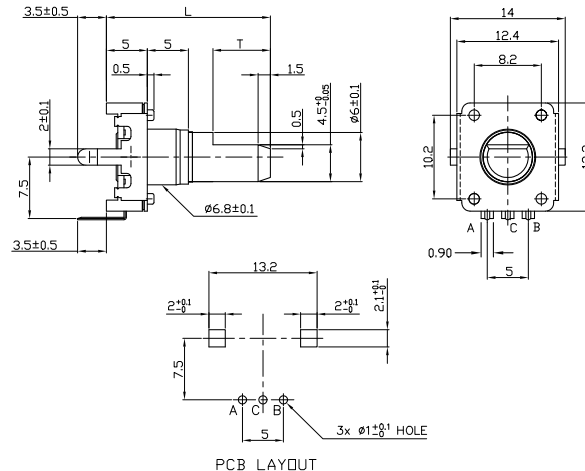

EN12-VS (Side Adjust, with Switch)

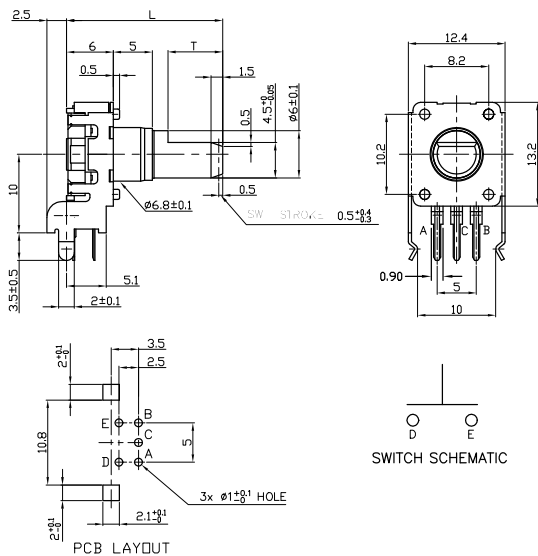

EN12-VN (Side Adjust, without Switch)

