

## STANDARD TRIACS

### FEATURES

- $I_{T(RMS)} = 25A$
- $V_{DRM} = 400V$  to  $800V$
- High surge current capability

### DESCRIPTION

The T25xxxH series of triacs uses a high performance MESA GLASS technology. These parts are intended for general purpose switching and phase control applications.

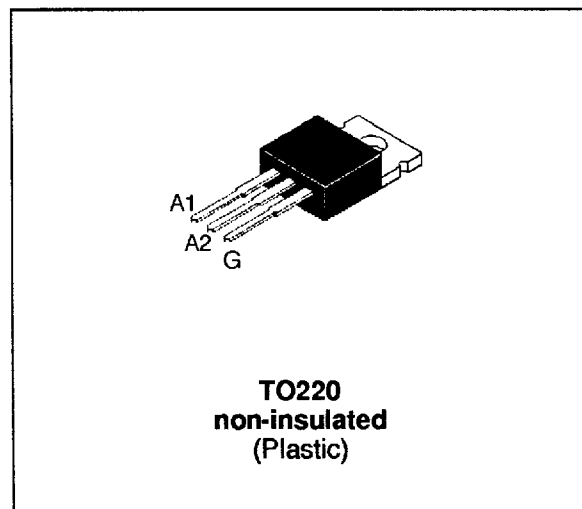

### ABSOLUTE RATINGS (limiting values)

Symbol	Parameter		Value	Unit
$I_{T(RMS)}$	RMS on-state current (360° conduction angle)	$T_c = 80\text{ °C}$	25	A
$I_{TSM}$	Non repetitive surge peak on-state current ( $T_j$ initial = $25\text{ °C}$ )	$t_p = 8.3\text{ ms}$	262	A
		$t_p = 10\text{ ms}$	250	
$I^2t$	$I^2t$ Value for fusing	$t_p = 10\text{ ms}$	312	$A^2s$
$di/dt$	Critical rate of rise of on-state current $I_G = 500\text{ mA}$ $di_G/dt = 1\text{ A}/\mu s$ .	Repetitive $F = 50\text{ Hz}$	10	$A/\mu s$
		Non Repetitive	50	
$T_{stg}$ $T_j$	Storage and operating junction temperature range		- 40, + 150 - 40, + 125	$^{\circ}C$
TI	Maximum lead temperature for soldering during 10s at 4.5mm from case		260	$^{\circ}C$

Symbol	Parameter	Voltage				Unit
		D	M	S	N	
$V_{DRM}$ $V_{RRM}$	Repetitive peak off-state voltage $T_j = 125\text{ °C}$	400	600	700	800	V

T25xxxH

**THERMAL RESISTANCES**

Symbol	Parameter	Value	Unit
Rth(j-a)	Junction to ambient	60	°C/W
Rth(j-c)	Junction to case for D.C	2	°C/W
Rth(j-c)	Junction to case for A.C 360° conduction angle (F=50Hz)	1.5	°C/W

**GATE CHARACTERISTICS** (maximum values)

$P_G (AV) = 1 W$   $P_{GM} = 10 W$  ( $t_p = 20 \mu s$ )  $I_{GM} = 4 A$  ( $t_p = 20 \mu s$ )

**ELECTRICAL CHARACTERISTICS**

Symbol	Test Conditions		Quadrant		Sensitivity		Unit
					12	13	
$I_{GT}$	$V_D = 12V$ (DC) $R_L = 33\Omega$	$T_j = 25^\circ C$	I-II-III	MAX	50	50	mA
			IV	MAX	50	75	
$V_{GT}$	$V_D = 12V$ (DC) $R_L = 33\Omega$	$T_j = 25^\circ C$	I-II-III-IV	MAX	1.5		V
$V_{GD}$	$V_D = V_{DRM}$ $R_L = 3.3k\Omega$	$T_j = 125^\circ C$	I-II-III-IV	MIN	0.2		V
$t_{gt}$	$V_D = V_{DRM}$ $I_G = 500mA$ $I_T = 35A$ $di_G/dt = 3A/\mu s$	$T_j = 25^\circ C$	I-II-III-IV	TYP	2		$\mu s$
$I_H^*$	$I_T = 250 mA$ Gate open	$T_j = 25^\circ C$		MAX	50	75	mA
$I_L$	$I_G = 1.2 I_{GT}$	$T_j = 25^\circ C$	I-III-IV	TYP	50	75	mA
			II	TYP	100	150	
$V_{TM}^*$	$I_{TM} = 35A$ $t_p = 380\mu s$	$T_j = 25^\circ C$		MAX	1.5		V
$I_{DRM}$ $I_{RRM}$	$V_D = V_{DRM}$ $V_R = V_{RRM}$	$T_j = 25^\circ C$		MAX	10		$\mu A$
		$T_j = 110^\circ C$		MAX	3		mA
$dV/dt^*$	$V_D = 67\% V_{DRM}$ Gate open	$T_j = 110^\circ C$		MIN	500		V/ $\mu s$
$(dV/dt)c^*$	$(di/dt)c = 11 A/ms$	$T_j = 110^\circ C$		MIN	5	10	V/ $\mu s$

\* For either polarity of electrode A<sub>2</sub> voltage with reference to electrode A<sub>1</sub>

**ORDERING INFORMATION**

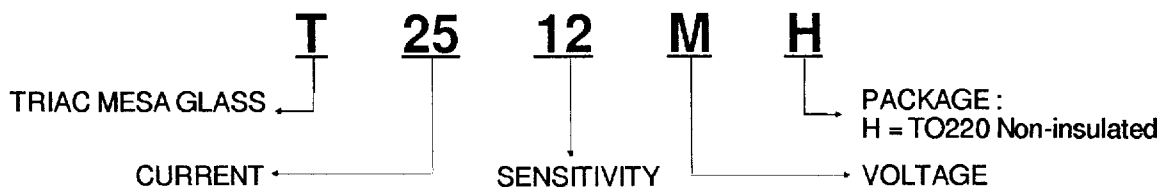

Fig.1 : Maximum RMS power dissipation versus RMS on-state current.

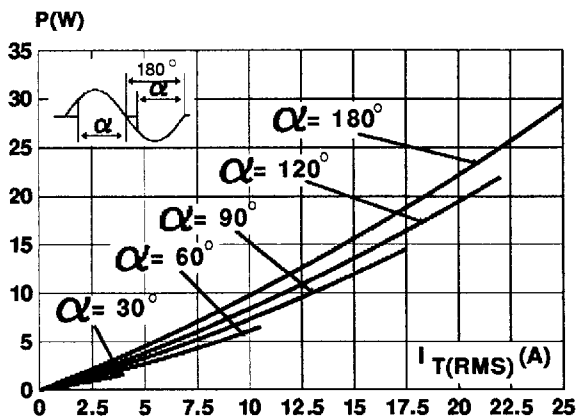

Fig.2 : Correlation between maximum RMS power dissipation and maximum allowable temperature (Tamb and Tcase) for different thermal resistances heatsink + contact.

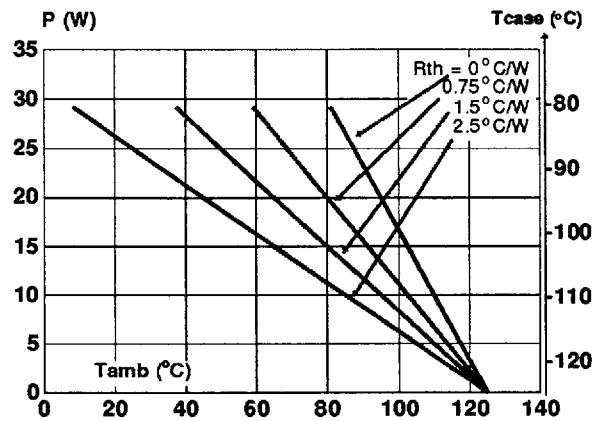

Fig.3 : RMS on-state current versus case temperature.

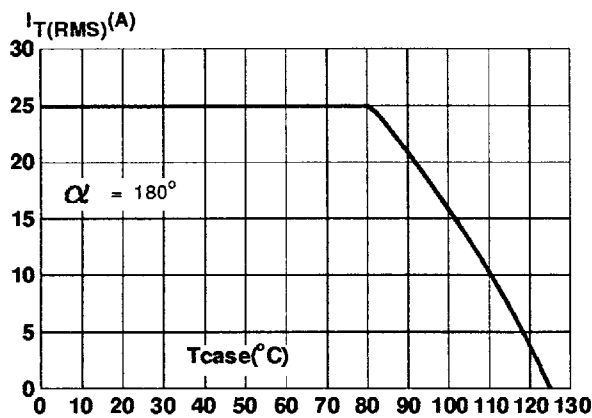

Fig.4 : Relative variation of thermal impedance versus pulse duration.

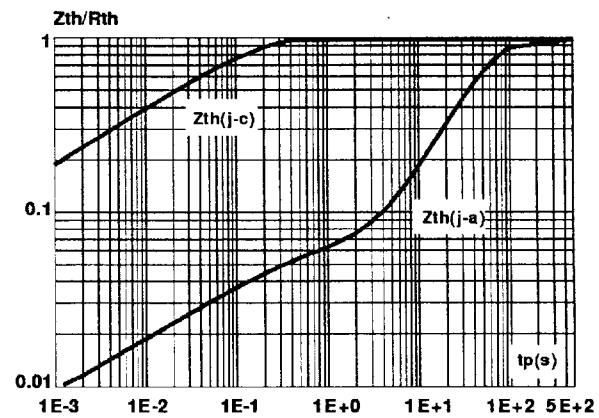

Fig.5 : Relative variation of gate trigger current and holding current versus junction temperature.

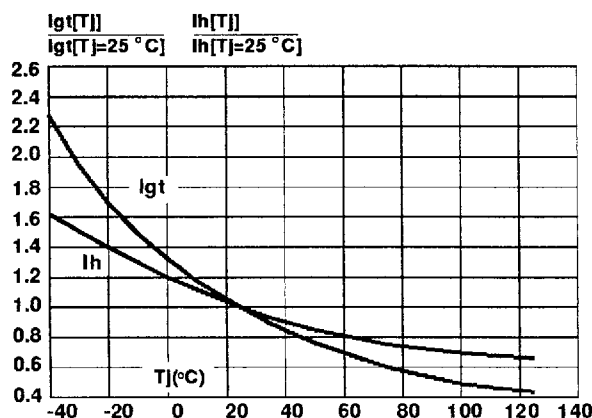
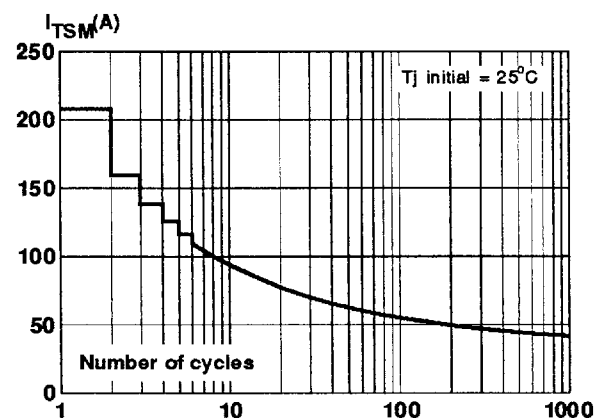

Fig.6 : Non repetitive surge peak on-state current versus number of cycles.



T25xxxH

Fig.7 : Non repetitive surge peak on-state current for a sinusoidal pulse with width :  $t \leq 10\text{ms}$ , and corresponding value of  $I^2t$ .

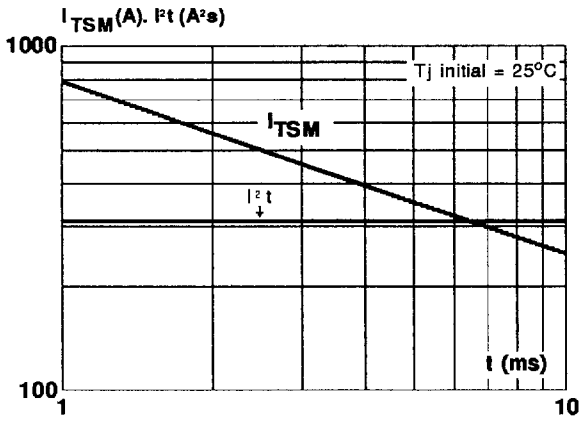
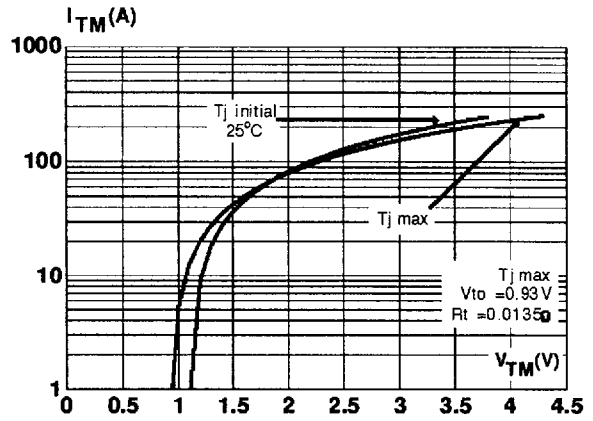

Fig.8 : On-state characteristics (maximum values).



**PACKAGE MECHANICAL DATA**  
 TO220 Non-insulated (Plastic)

REF.	DIMENSIONS					
	Millimeters			Inches		
	Typ.	Min.	Max.	Typ.	Min.	Max.
A			10.3			0.406
B		6.3	6.5	0.248	0.256	
C			9.1			0.358
D		12.7			0.500	
F			4.2			0.165
G			3.0			0.118
H		4.5	4.7		0.177	0.185
I		3.53	3.66		0.139	0.144
J		1.2	1.3		0.047	0.051
L			0.9			0.035
M	2.7			0.106		
N			5.3			0.209
N1	2.54			0.100		
O		1.2	1.4		0.047	0.055
P			1.15			0.045

Marking : type number  
 Weight : 1.8 g

Information furnished is believed to be accurate and reliable. However, SGS-THOMSON Microelectronics assumes no responsibility for the consequences of use of such information nor for any infringement of patents or other rights of third parties which may result from its use. No license is granted by implication or otherwise under any patent or patent rights of SGS-THOMSON Microelectronics. Specifications mentioned in this publication are subject to change without notice. This publication supersedes and replaces all information previously supplied. SGS-THOMSON Microelectronics products are not authorized for use as critical components in life support devices or systems without express written approval of SGS-THOMSON Microelectronics.

© 1995 SGS-THOMSON Microelectronics - All rights reserved.

SGS-THOMSON Microelectronics GROUP OF COMPANIES

Australia - Brazil - France - Germany - Hong Kong - Italy - Japan - Korea - Malaysia - Malta - Morocco - The Netherlands  
 Singapore - Spain - Sweden - Switzerland - Taiwan - Thailand - United Kingdom - U.S.A.