

TRS-5380-CXX0G / TRS-5380T-CXX0G / TRS-5380F-CXX0G

CWDM 3.3V / 622 Mbps RoHS Compliant Optical Single-Mode Transceiver

FEATURES

- I Duplex SC/ST/FC Single Mode Transceiver
- I Long-Reach SONET OC-12 / SDH STM-4 Compliant
- I 18-Wavelength CWDM DFB LD Transmitter from 1270 nm to 1610 nm, with step 20 nm
- I 29 dB Link Budget at Least
- I Industry Standard 1 x 9 Footprint
- I Single +3.3 V Power Supply
- I RoHS Compliant
- I PECL Signal Detect Output: TRS-5380/T/F-CXX0G
- I TTL Signal Detect Output: TRS-5380C/T/F-CXX0G
- I Wave Solderable and Aqueous Washable
- I Class 1 Laser International Safety Standard IEC-60825 Compliant

DESCRIPTION

The TRS-5380-CXX0G series single mode transceivers is low power, high performance CWDM modules for bi-directional serial optical data communications such as SONET OC-12 / SDH STM-4 and Fiber Channel. There are eighteen center wavelengths from 1270 nm to 1610 nm, each step 20 nm. A guaranteed minimum optical link budget of 29 dB is offered. The transmitter section uses a multiple quantum well CWDM DFB laser and is a class 1 laser compliant according to International Safety Standard IEC-60825. The receiver section uses an integrated InGaAs detector preamplifier (IDP) mounted in an optical header and a limiting post-amplifier IC. A PECL logic interface simplifies interface to external circuitry.

APPLICATIONS

- I ATM 622 Mbps Links
- I SONET/SDH Equipment Interconnect
- I Fiber Channel 532 Mb/s Links
- I CWDM

LASER SAFETY

This single mode transceiver is a Class 1 laser product. It complies with IEC-60825 and FDA 21 CFR 1040.10 and 1040.11. The transceiver must be operated within the specified temperature and voltage limits. The optical ports of the module shall be terminated with an optical connector or with a dust plug.

ORDER INFORMATION

P/No.	Bit Rate (Mb/s)	SONET /SDH	Power Budget (dB)	Wavelength (nm)	Voltage (V)	Package	Temp. (°C)	TX Power (dBm)	RX Sens. (dBm)	RoHS Compliant
TRS-5380-CXX0G	622	LR	> 29	CWDM*	3.3	1X9 SC/ST/FC	0 to 70	5 to 0	-29	Y

CWDM Wavelength (0 to 70°C)

Central Wavelength	Min. (nm)	Typ. (nm)	Max. (nm)	Central Wavelength	Min. (nm)	Typ. (nm)	Max. (nm)
-C270	1264.5	1270	1277.5	-C450	1444.5	1450	1457.5
-C290	1284.5	1290	1297.5	-C470	1464.5	1470	1477.5
-C310	1304.5	1310	1317.5	-C490	1484.5	1490	1497.5
-C330	1324.5	1330	1337.5	-C510	1504.5	1510	1517.5
-C350	1344.5	1350	1357.5	-C530	1524.5	1530	1537.5
-C370	1364.5	1370	1377.5	-C550	1544.5	1550	1557.5
-C390	1384.5	1390	1397.5	-C570	1564.5	1570	1577.5
-C410	1404.5	1410	1417.5	-C590	1584.5	1590	1597.5
-C430	1424.5	1430	1437.5	-C610	1604.5	1610	1617.5

CWDM*: 18 Wavelengths from 1270 nm to 1610 nm, each step 20 nm.

Absolute Maximum Ratings					
Parameter	Symbol	Min	Max	Units	Notes
Storage Temperature	Tstg	-40	85	°C	
Operating Temperature	Topr	0	70	°C	With air flow 1m/sec
Soldering Temperature	---		260	°C	10 seconds on leads only
Power Supply Voltage	Vcc	0	4.5	V	
Input Voltage	---	GND	Vcc	V	
Output Current	Iout	0	30	mA	

Recommended Operating Conditions					
Parameter	Symbol	Min	Typ	Max	Units
Power Supply Voltage	Vcc	3.1	3.3	3.5	V
Operating Temperature	Topr	0		70	°C / air flow 1m/sec
Data Rate		50	622		Mb/s
Power Supply Current	Icc			280	mA

Transmitter Specifications (0°C < Topr < 70°C, 3.1V < Vcc < 3.5V)						
Parameter	Symbol	Min	Typ	Max	Units	Notes
Optical						
Optical Transmit Power	Po	0	---	5	dBm	1
Output Center Wavelength	λ	$\lambda-5.5$	λ	$\lambda+7.5$	nm	2
Output Spectrum Width	$\Delta\lambda$	---	---	1	nm	-20 dB Width
Side Mode Suppression Ratio	SMSR	30			dB	
Extinction Ratio	E _R	10	---	---	dB	
Output Eye	Compliant with Bellcore TR-NWT-000253 and ITU recommendation G.957					
Optical Rise Time	t _r			1.2	ns	10% to 90% Values
Optical Fall Time	t _f			1.2	ns	10% to 90% Values
Relative Intensity Noise	RIN			-120	dB/Hz	
Total Jitter	TJ			0.55	ns	3
Electrical						
Data Input Current – Low	I _{IL}	-350			μA	
Data Input Current – High	I _{IH}			350	μA	
Differential Input Voltage	V _{IH} - V _{IL}	300			mV	
Data Input Voltage – Low	V _{IL} - V _{CC}	-2.0		-1.58	V	4
Data Input Voltage -- High	V _{IH} - V _{CC}	-1.1		-0.74	V	4

Notes: 1. Output power is power coupled into a 9/125 μm single mode fiber.

2. ITU-T G.694.2 CWDM wavelength from 1270 nm to 1610 nm, each step 20 nm.

3. Measured with a 2²³-1 PRBS with 72 ones and 72 zeros.

4. These inputs are compatible with 10K, 10KH and 100K ECL and LVPECL inputs.

Receiver Specifications (0°C < Topr < 70°C, 3.1 V < Vcc < 3.5V)						
Parameter	Symbol	Min	Typ	Max	Units	Notes
Optical						
Sensitivity	---	---	---	-29	dBm	1
Maximum Input Power	Pin	-3	---	---	dBm	
Signal Detect -- Asserted	Pa	---	---	-29	dBm	Transition: low to high
Signal Detect -- Deasserted	Pd	-40	---	---	dBm	Transition: high to low
Signal detect -- Hysteresis		1.0	---		dB	
Wavelength of Operation		1100	---	1620	nm	
Electrical						
Data Output Voltage – Low	V _{OL} - V _{CC}	-2.0		-1.58	V	2
Data Output Voltage – High	V _{OH} - V _{CC}	-1.1		-0.74	V	2
Signal Detect Output Voltage -- Low	V _{OL} - V _{CC}	-2.0		-1.58	V	TRS-5380-CXX0G
Signal Detect Output Voltage -- High	V _{OH} - V _{CC}	-1.1		-0.74	V	
Signal Detect Output Voltage -- Low	V _{SDL}			0.8	V	TRS-5380C-CXX0G
Signal Detect Output Voltage -- High	V _{SDH}	2.0			V	

Notes: 1. Minimum sensitivity and saturation levels at BER1E-10 for a 2²³-1 PRBS with 72 ones and 72 zeros.
 2. These outputs are compatible with 10K, 10KH and 100K ECL and LVPECL outputs.

CONNECTION DIAGRAM

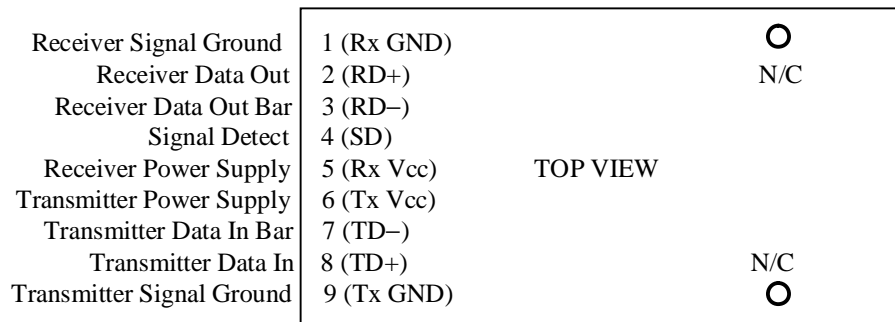

PIN	Symbol	Notes
1	Rx GND	Directly connect this pin to the receiver ground plane
2	RD+	See recommended circuit schematic
3	RD-	See recommended circuit schematic
4	SD	Active high on this indicates a received optical signal
5	Rx Vcc	+3.3V dc power for the receiver section
6	Tx Vcc	+3.3V dc power for the transmitter section
7	TD-	See recommended circuit schematic
8	TD+	See recommended circuit schematic
9	Tx GND	Directly connect this plan to the transmitter ground plane

RECOMMENDED CIRCUIT SCHEMATIC

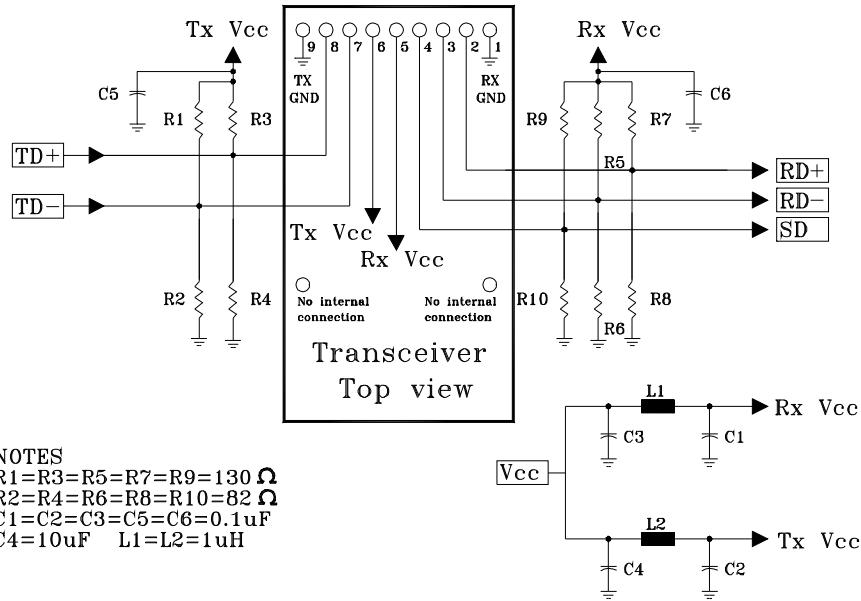

The split-load terminations for ECL signals need to be located at the input of devices receiving those ECL signals. The power supply filtering is required for good EMI performance. Use short tracks from the inductor L1/L2 to the module Rx Vcc and Tx Vcc. A GND plane under the module is required for good EMI and sensitivity performance.

PACKAGE DIAGRAM

Units in mm

1) SC Type

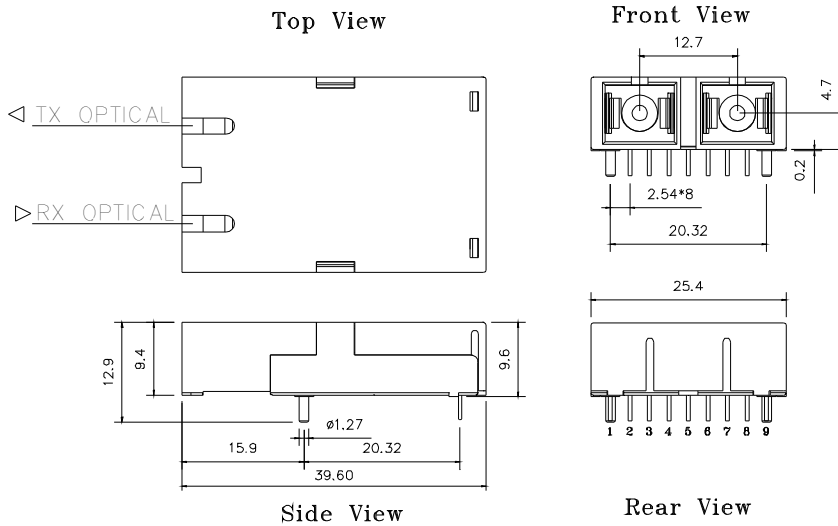

TRS-5380-CXX0G / TRS-5380C-CXX0G

2) SC Type With Extended Shielding

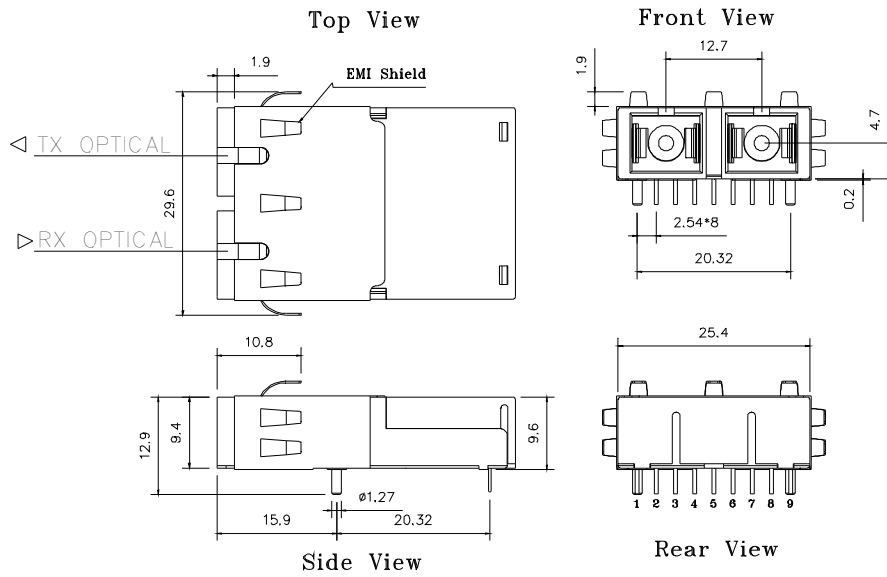

TRS-5380-CXX0-EMG / TRS-5380C-CXX0-EMG

3) ST Type

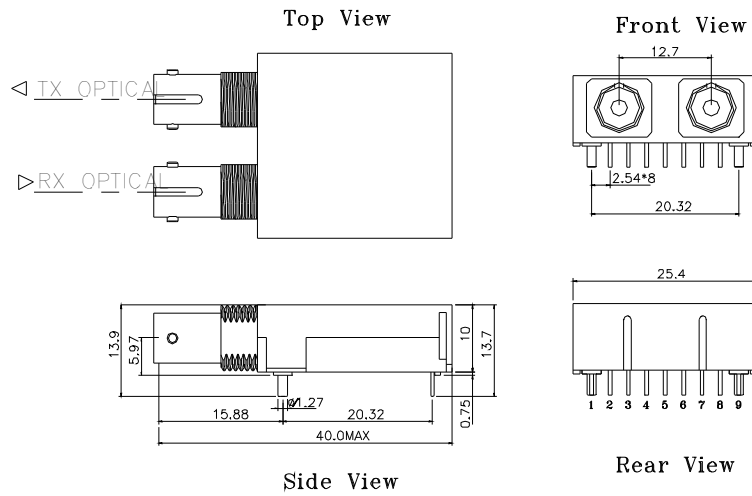

TRS-5380T-CXX0G / TRS-5380CT-CXX0G

4) FC Type

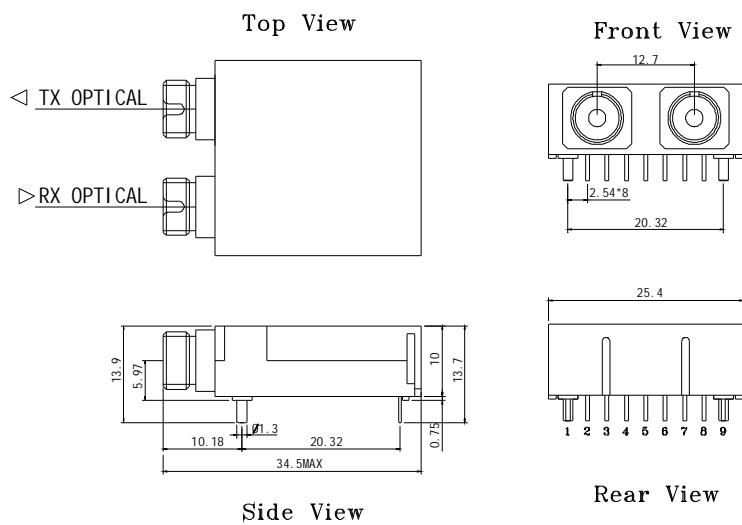

TRS-5380F-CXX0G / TRS-5380CF-CXX0G

Note: Specifications subject to change without notice.