

Am9101 Family

256 x 4 Static RAM

Am9101 Family

DISTINCTIVE CHARACTERISTICS

- Low operating power
125 mW typ.; 290 mW maximum — standard power
100 mW typ.; 175 mW maximum — low power
- High output drive — two full TTL loads
- High noise immunity — full 400 mV
- Two chip enable inputs
- Output disable control
- Low voltage levels identical to TTL

GENERAL DESCRIPTION

The Am9101/Am91L01 series of devices are high-performance, low-power, 1024-bit, Static, Read/Write Random Access Memories. They offer a wide range of access times including versions as fast as 200 ns. Each memory is implemented as 256 words by 4 bits per word. This organization permits efficient design of small memory systems and allows finer resolution of incremental memory depth.

These memories may be operated in a DC standby mode for reductions of as much as 84% of the normal power dissipation. Data can be retained with a power supply as low as 1.5 volts. The low power Am91L01 series offer

reduced power dissipation during normal operating conditions and even lower dissipation in the standby mode.

The Chip Enable input control signals act as high order address lines and they control the write amplifier and the output buffers. The Output Disable signal provides independent control over the output state of enabled chips.

These devices are fully static and no refresh operations, sense amplifiers or clocks are required. Input and output signal levels are identical to TTL specifications, providing simplified interfacing and high noise immunity. The outputs will drive two full TTL loads for increased fan-out and better bus interfacing capability.

BLOCK DIAGRAM

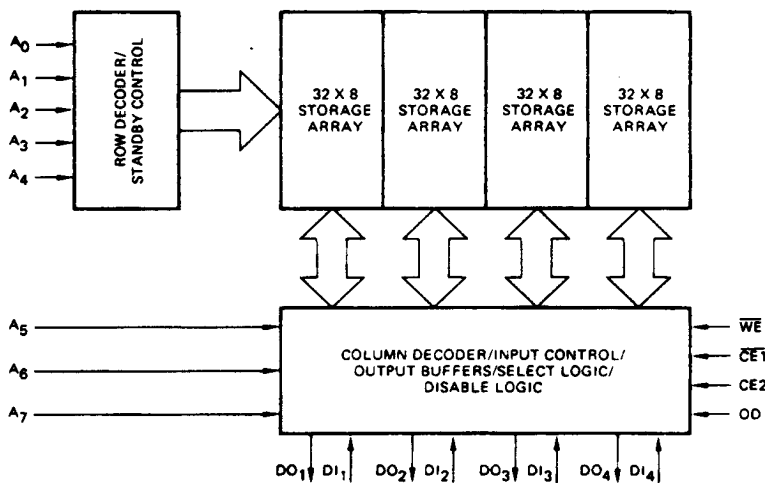

BD000100

Publication # 03255 Rev. D Amendment /0
Issue Date: May 1986

CONNECTION DIAGRAM Top View

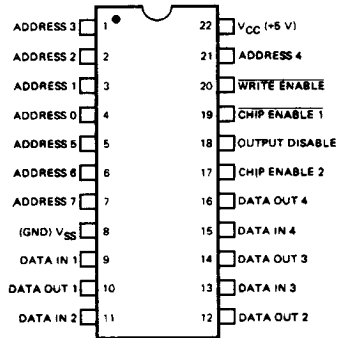

CD000151

Note: Pin 1 is marked for orientation.

METALLIZATION AND PAD LAYOUT

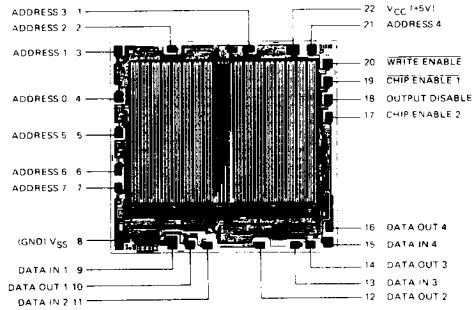

Die Size 0.132" x 0.131"

4

ORDERING INFORMATION (Cont'd.)

Standard Products

AMD standard products are available in several packages and operating ranges. The order number (Valid Combination) is formed by a combination of:

- A. Device Number**
- B. Speed Option** (if applicable)
- C. Package Type**
- D. Temperature Range**
- E. Optional Processing**

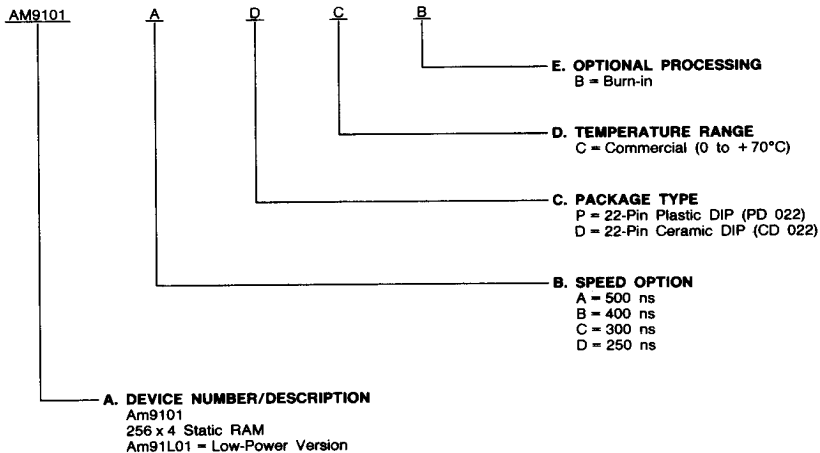

Valid Combinations	
✓ AM9101A	PC, PCB, DC, DCB
✓ AM9101B	
✓ AM9101C	
✓ AM9101D	
✓ AM91L01A	
✓ AM91L01B	
✓ AM91L01C	

Valid Combinations

Valid Combinations list configurations planned to be supported in volume for this device. Consult the local AMD sales office to confirm availability of specific valid combinations, to check on newly released combinations, and to obtain additional data on AMD's standard military grade products.

ORDERING INFORMATION

CPL Products

AMD products for Aerospace and Defense applications are available in several packages and operating ranges. APL (Approved Products List) products are fully compliant with MIL-STD-883C requirements. CPL (Controlled Products List) products are processed in accordance with MIL-STD-883C, but are inherently non-compliant because of package, solderability, or surface treatment exceptions to those specifications. The order number (Valid Combination) for CPL products is formed by a combination of:

- A. Device Number**
- B. Speed Option** (if applicable)
- C. Package Type**
- D. Temperature Range**
- E. CPL Status**

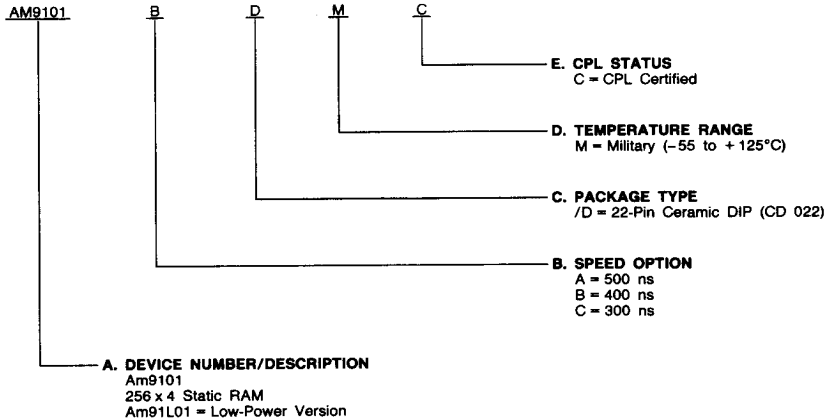

Valid Combinations	
AM9101A	/DMC
AM9101B	
AM9101C	
AM91L01A	
AM91L01B	
AM91L01C	

Valid Combinations

Valid Combinations list configurations planned to be supported in volume for this device. Consult the local AMD sales office to confirm availability of specific valid combinations or to check for newly released valid combinations.

ORDERING INFORMATION

Commodity Products

AMD commodity products are available in several packages and operating ranges. The order number (Valid Combination) is formed by a combination of:

- A. Temperature Range**
- B. Package Type**
- C. Device Number**
- D. Speed Option**

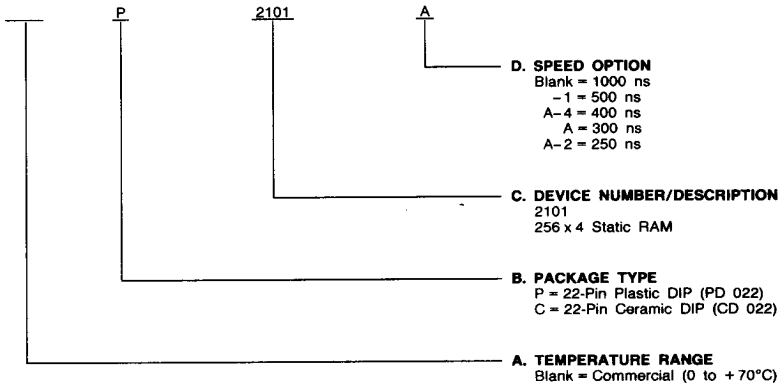

Valid Combinations		
P, C	2101	-1, A-4, A, A-2

Valid Combinations

Valid Combinations list configurations planned to be supported in volume for this device. Consult the local AMD sales office to confirm availability of specific valid combinations, to check on newly released valid combinations, and to obtain additional data on AMD's standard military grade products.

PIN DESCRIPTION

A₀ - A₇ Addresses (Input)

The 8-bit field presented at the address inputs selects one of the 256 memory locations to be read from — or written into — via the Data Input/Output lines.

DI₁ - DI₄ Data In Lines (Input)

The inputs whose states represent the data to be stored in memory.

DO₁ - DO₄ Data In Lines (Output)

The outputs whose states represent the data to be stored in memory.

$\overline{CE1}$, CE2 Chip Enable Signals (Input)

Read and Write cycles can be executed only when $\overline{CE1}$ is LOW and CE2 is HIGH.

WE Write Enable (Input, Active LOW)

Data is written into the memory if \overline{WE} is LOW and read from the memory if WE is HIGH.

OD Output Disable (Input)

Read cycles can be executed only when OD is LOW.

FUNCTIONAL DESCRIPTION

Applications

Refer to Figure 1 for Memory System information.

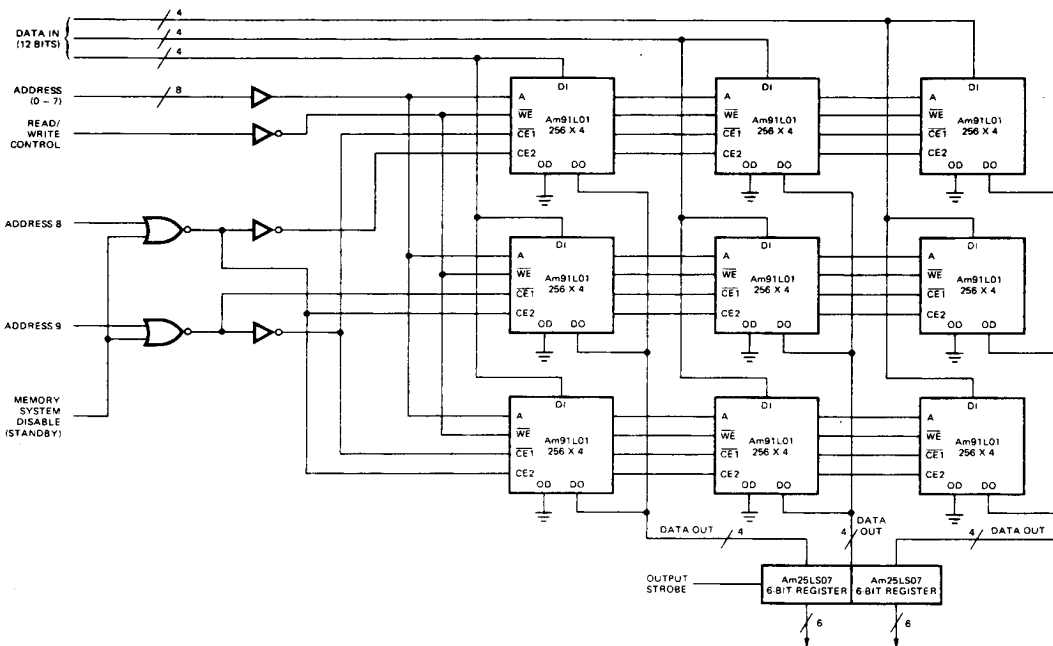

AF000090

Figure 1. Memory System 768 Words by 12 Bits Per Word

4

ABSOLUTE MAXIMUM RATINGS (Note 1)

Storage Temperature	-65 to +150°C
Ambient Temperature with Power Applied	-55 to +125°C
Supply Voltage	-0.5 V to +7.0 V
DC Voltage Applied to Outputs	-0.5 V to +7.0 V
DC Layout Voltage	-0.5 V to +7.0 V
Power Description	1.0 W
DC Output Current	20 mA

Stresses above those listed under ABSOLUTE MAXIMUM RATINGS may cause permanent device failure. Functionality at or above these limits is not implied. Exposure to absolute maximum ratings for extended periods may affect device reliability.

OPERATING RANGES (Note 2)

Commercial (C) Devices	Temperature	0 to +70°C
	Supply Voltage	+4.75 V to +5.25 V
Military (M) Devices*	Temperature	-55 to +125°C
	Supply Voltage	+4.5 V to +5.5 V

Operating ranges define those limits between which the functionality of the device is guaranteed.

*Military product 100% tested at $T_C = +25^\circ\text{C}$, $+125^\circ\text{C}$, and -55°C .

DC CHARACTERISTICS over operating range unless otherwise specified*

Parameter Symbol	Parameter Description	Test Conditions	Am9101/ Am91L01		Am2101		Units	
			Min.	Max.	Min.	Max.		
V_{OH}	Output HIGH Voltage	$V_{CC} = \text{Min.}$	$I_{OH} = -200 \mu\text{A}$	2.4		2.2	V	
V_{OL}	Output LOW Voltage	$V_{CC} = \text{Min.}$	$I_{OL} = 3.2 \text{ mA}$		0.4		V	
			$I_{OL} = 2.0 \text{ mA}$			0.45	V	
V_{IH}	Input HIGH Voltage			2.0	V_{CC}	2.0	V_{CC}	
V_{IL}	Input LOW Voltage			-0.5	0.8	-0.5	0.65	
I_{LI}	Input Load Current	$V_{CC} = \text{Max.}, 0 \leq V_{IN} \leq V_{CC}$			10		10	
							μA	
I_{LO}	Output Leakage Current	$V_{CE} = V_{IH}$	$V_O = V_{CC}$	C devices	5.0	15	μA	
				M devices	10			
			$V_O = 0.4 \text{ V}$		-10	-50		
I_{CC1}	Power Supply Current	Data Out Open $V_{CC} = \text{Max.}$ $V_{IN} = V_{CC}$	$T_A = 25^\circ\text{C}$ (Note 3)	Am9101A/B	50		mA	
				Am9101C/D/E	55			
				Am91L01A/B	31			
				Am91L01C/D/E	34			
				Am2101		60		
				Am9101A/B	55			
			$T_A = 0^\circ\text{C}$ (C devices only)	Am9101C/D/E	60			
				Am91L01A/B	33			
				Am91L01C/D/E	36			
				Am2101		70		
				$T_A = -55^\circ\text{C}$ (M devices only)	Am9101A/B	60		
					Am9101C/D/E	65		
Am91L01A/B	37							
Am91L01C/D/E	40							
			Am2101					
C_{IN}	Input Capacitance	$T_A = 25^\circ\text{C}, f = 1 \text{ MHz}, V_{IN} = 0 \text{ V}$ (Note 3)			9	9	pF	
C_O	Output Capacitance	$T_A = 25^\circ\text{C}, f = 1 \text{ MHz}, V_O = 0 \text{ V}$ (Note 3)			12	12	pF	

- Notes: 1. Absolute maximum ratings are intended for user guidelines and are not tested.
 2. For test and correlation purposes, ambient temperature is defined as the stabilized case temperature.
 3. Guaranteed by characterization data. Data will be updated upon any process or design change which affects this parameter.
 4. Test conditions assume signal transition times of 10 ns or less. Output load equals 1 TTL gate + 100 pF. Input signal timing reference level = 1.5 V, with input pulse levels of 0 to 3.0 V. Data output timing reference levels = 0.8 and 2.0 V.
 5. Both $\overline{CE1}$ and $\overline{CE2}$ must be true to enable the chip.

*See the last page of this spec for Group A Subgroup Testing information.

STANDBY OPERATING CONDITIONS over temperature range unless otherwise specified

Parameter Symbol	Parameter Description	Test Conditions		Min.	Typ.	Max.	Units
V _{PD}	V _{CC} in Standby Mode			1.5			
I _{PD}	I _{CC} in Standby Mode	T _A = 0°C All Inputs = V _{PD}	V _{PD} = 1.5 V	Am91L01	11	25	mA
				Am9101	13	31	
			V _{PD} = 2.0 V	Am91L01	13	31	
				Am9101	17	41	
		T _A = -55°C All Inputs = V _{PD}	V _{PD} = 1.5 V	Am91L01	11	28	mA
				Am9101	13	34	
			V _{PD} = 2.0 V	Am91L01	13	34	
				Am9101	17	46	
dv/dt	Rate of Change of V _{CC}					1.0	V/μs
t _R	Standby Recovery Time			t _{RC}			ns
t _{CP}	Chip Deselect Time			0			ns
V _{CES}	CE Bias in Standby			V _{PD}			Volts

Power-Down Standby Operation

The Am9101/AM91L01 Family is designed to maintain storage in a standby mode. The standby mode is entered by lowering V_{CC} to around 1.5 – 2.0 volts (see table and graph). When the voltage to the device is reduced, the storage cells are isolated from the data lines, so their contents will not change. The standby mode may be used by a battery operated

backup power supply system, or, in a large system, memory pages not being accessed can be placed in standby to save power. A standby recovery time must elapse following restoration of normal power before the memory may be accessed.

To ensure that the output of the device is in a high-impedance OFF state during standby, the chip select should be held at V_{IH} or V_{CES} during the entire standby cycle.

TYPICAL DC AND AC CHARACTERISTICS

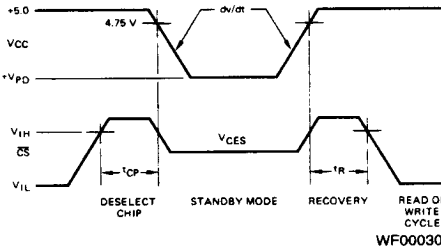

Typical Power Supply Current Versus Voltage

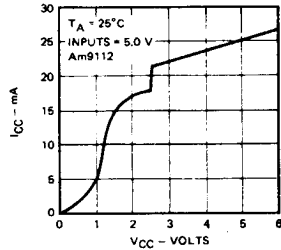

Typical Output Current Versus Voltage

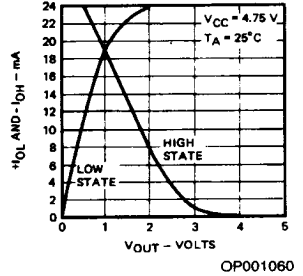

Access Time Versus VCC Normalized to VCC = +5.0 Volts

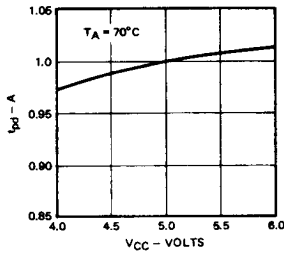

Typical Power Supply Current Versus Ambient Temperature

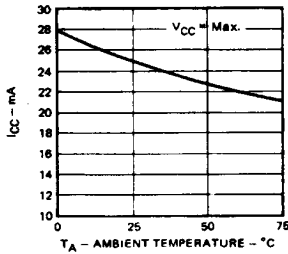

Typical VIN Limits Versus Ambient Temperature

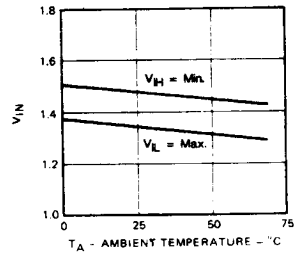

Typical tA Versus Ambient Temperature

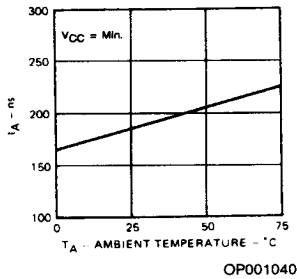

Typical tA Versus CL

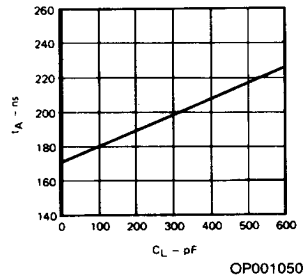

SWITCHING CHARACTERISTICS over operating range unless otherwise specified (Note 4)*

No.	Parameter Symbol	Parameter Description	Am2101		Am2101-2		Am2101-1		Units
			Min.	Max.	Min.	Max.	Min.	Max.	
1	t _{RC}	Read Cycle Time	1000		650		500		ns
2	t _A	Access Time		1000		650		500	ns
3	t _{CO}	Chip Enable to Output ON Delay (Note 5)		800		400		350	ns
4	t _{OD}	Output Disable to Output ON Delay		700		350		300	ns
5	t _{OH}	Previous Read Data Valid with Respect to Address Change	0		0		0		ns
6	t _{DF1}	Output Disable to Output OFF Delay (Note 3)	0	200	0	150	0	150	ns
7	t _{DF2}	Chip Enable to Output OFF Delay (Note 3)	0	200	0	150	0	150	ns
8	t _{WC}	Write Cycle Time	1000		650		500		ns
9	t _{AW}	Address Set-up Time	150		150		100		ns
10	t _{WP}	Write Pulse Width	750		400		300		ns
11	t _{CW}	Chip Enable Set-up Time (Note 5)	900		550		400		ns
12	t _{WR}	Address Hold Time	50		50		50		ns
13	t _{DW}	Input Data Set-up Time	700		400		280		ns
14	t _{DH}	Input Data Hold Time	100		100		100		ns

No.	Parameter Symbol	Parameter Description	Am9101A Am91L01A		Am9101B Am91L01B		Am9101C Am91L01C		Am9101D		Units
			Min.	Max.	Min.	Max.	Min.	Max.	Min.	Max.	
1	t _{RC}	Read Cycle Time	500		400		300		250		ns
2	t _A	Access Time		500		400		300		250	ns
3	t _{CO}	Chip Enable to Output ON Delay (Note 5)		200		175		150		125	ns
4	t _{OD}	Output Disable to Output ON Delay		175		150		125		100	ns
5	t _{OH}	Previous Read Data Valid with Respect to Address Change	40		40		40		30		ns
6	t _{DF1}	Output Disable to Output OFF Delay	5.0	125	5.0	100	5.0	100	5.0	75	ns
7	t _{DF2}	Chip Enable to Output OFF Delay	10	125	10	125	10	100	10	100	ns
8	t _{WC}	Write Cycle Time	500		400		300		250		ns
9	t _{AW}	Address Set-up Time	20		20		20		20		ns
10	t _{WP}	Write Pulse Width	225		200		175		150		ns
11	t _{CW}	Chip Enable Set-up Time (Note 5)	175		150		125		100		ns
12	t _{WR}	Address Hold Time	0		0		0		0		ns
13	t _{DW}	Input Data Set-up Time	150		125		100		85		ns
14	t _{DH}	Input Data Hold Time	15		15		15		15		ns

See notes following DC Characteristics table.
 *See the last page of this spec for Group A Subgroup Testing information.

4

SWITCHING WAVEFORMS

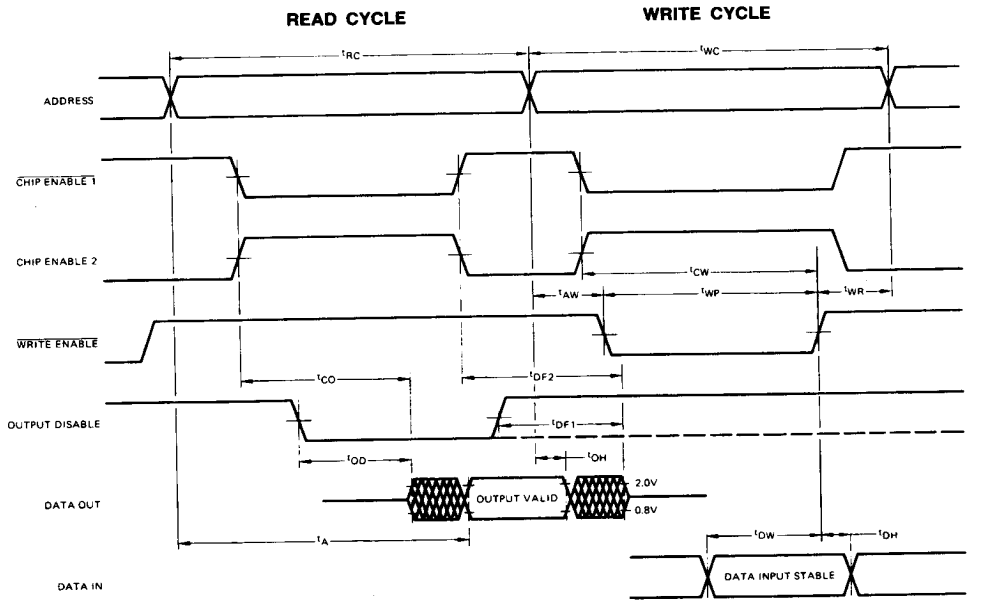

WF000200

GROUP A SUBGROUP TESTING

DC CHARACTERISTICS

Parameter Symbol	Subgroups
V _{OH}	1, 2, 3
V _{OL}	1, 2, 3
V _{IH}	1, 2, 3
V _{IL}	1, 2, 3
I _{LI}	1, 2, 3
I _{LO}	1, 2, 3
I _{CC1}	1, 2, 3
V _{PD}	1, 2, 3
I _{PD}	1, 2, 3

SWITCHING CHARACTERISTICS

No.	Parameter Symbol	Subgroups
1	t _{RC}	7, 8, 9, 10, 11
2	t _A	7, 8, 9, 10, 11
3	t _{CO}	7, 8, 9, 10, 11
4	t _{OD}	7, 8, 9, 10, 11
5	t _{OH}	7, 8, 9, 10, 11
8	t _{WC}	7, 8, 9, 10, 11
9	t _{AW}	7, 8, 9, 10, 11
10	t _{WP}	7, 8, 9, 10, 11
11	t _{CW}	7, 8, 9, 10, 11
12	t _{WR}	7, 8, 9, 10, 11
13	t _{DW}	7, 8, 9, 10, 11
14	t _{DH}	7, 8, 9, 10, 11

MILITARY BURN-IN

Military burn-in is in accordance with the current revision of MIL-STD-883, Test Method 1015, Conditions A through E. Test conditions are selected at AMD's option.