



**Genesys Logic, Inc.**

---

**GL842**

**USB 2.0 2-in-1  
Scanner Controller**

**Datasheet  
Revision 1.00  
Nov. 14, 2003**



## **Copyright:**

Copyright © 2003 Genesys Logic Incorporated. All rights reserved. No part of the materials may be reproduced in any form or by any means without prior written consent of Genesys Logic Inc..

## **Disclaimer:**

ALL MATERIALS ARE PROVIDED "AS IS" WITHOUT EXPRESS OR IMPLIED WARRANTY OF ANY KIND. NO LICENSE OR RIGHT IS GRANTED UNDER ANY PATENT OR TRADEMARK OF GENESYS LOGIC INC.. GENESYS LOGIC HEREBY DISCLAIMS ALL WARRANTIES AND CONDITIONS IN REGARD TO MATERIALS, INCLUDING ALL WARRANTIES, IMPLIED OR EXPRESS, OF MERCHANTABILITY, FITNESS FOR ANY PARTICULAR PURPOSE, AND NON-INFRINGEMENT OF INTELLECTUAL PROPERTY. IN NO EVENT SHALL GENESYS LOGIC BE LIABLE FOR ANY DAMAGES INCLUDING, WITHOUT LIMITATION, DAMAGES RESULTING FROM LOSS OF INFORMATION OR PROFITS. PLEASE BE ADVISED THAT THE MATERIALS MAY CONTAIN ERRORS OR OMMISIONS. GENESYS LOGIC MAY MAKE CHANGES TO THE MATERIALS OR TO THE PRODUCTS DESCRIBED THEREIN AT ANY TIME WITHOUT NOTICE.

## **Trademarks:**



is a registered trademark of Genesys Logic Inc..  
All trademarks are the properties of their respective owners.

## **Office:**

### **Genesys Logic, Inc.**

12F, No. 205, Sec. 3, Beishin Rd., Shindian City,  
Taipei, Taiwan  
Tel: (886-2) 8913-1888  
Fax: (886-2) 6629-6168

<http://www.genesyslogic.com>



## **Revision History**

<b>Revision</b>	<b>Date</b>	<b>Description</b>
1.00	11/14/2003	First formal release



## TABLE OF CONTENTS

<b>CHAPTER 1</b>	<b>GENERAL DESCRIPTION</b> .....	<b>6</b>
<b>CHAPTER 2</b>	<b>FEATURES</b> .....	<b>7</b>
<b>CHAPTER 3</b>	<b>PIN ASSIGNMENT</b> .....	<b>8</b>
<b>3.1</b>	<b>PINOUTS</b> .....	<b>8</b>
<b>3.2</b>	<b>PIN LIST</b> .....	<b>9</b>
<b>3.3</b>	<b>PIN DESCRIPTIONS</b> .....	<b>10</b>
<b>CHAPTER 4</b>	<b>REGISTERS</b> .....	<b>14</b>
<b>4.1</b>	<b>REGISTERS BASE ADDRESS</b> .....	<b>14</b>
<b>4.2</b>	<b>REGISTER DESCRIPTIONS</b> .....	<b>18</b>
<b>4.3</b>	<b>REGISTER MAPPING</b> .....	<b>52</b>
<b>4.3.1</b>	<b>Shading Mapping (Chunky for Single Bank)</b> .....	<b>52</b>
<b>4.3.2</b>	<b>Shading Mapping (Planer)</b> .....	<b>52</b>
<b>4.3.3</b>	<b>Slope Curve Table Mapping</b> .....	<b>53</b>
<b>4.3.4</b>	<b>Image Buffer Mapping</b> .....	<b>53</b>
<b>CHAPTER 5</b>	<b>BLOCK DIAGRAM</b> .....	<b>54</b>
<b>5.1</b>	<b>USB2.0 SYSTEM BLOCK DIAGRAM</b> .....	<b>54</b>
<b>5.2</b>	<b>FUNCTION BLOCK DIAGRAM</b> .....	<b>54</b>
<b>CHAPTER 6</b>	<b>FUNCTIONAL DESCRIPTION</b> .....	<b>55</b>
<b>CHAPTER 7</b>	<b>ELECTRICAL CHARACTERISTICS</b> .....	<b>62</b>
<b>7.1</b>	<b>ABSOLUTE MAXIMUM RATINGS (VOLTAGE REFERENCED TO GND)</b> .....	<b>62</b>
<b>7.2</b>	<b>DC CHARACTERISTICS (DIGITAL PINS): 3.3 V LOGIC CORE OR PADS</b> .....	<b>62</b>
<b>7.3</b>	<b>DC CHARACTERISTICS (DIGITAL PINS): 5.0 V PADS</b> .....	<b>63</b>
<b>7.4</b>	<b>DC CHARACTERISTICS (D+/D-)</b> .....	<b>63</b>
<b>CHAPTER 8</b>	<b>PACKAGE DIMENSION</b> .....	<b>64</b>



## LIST OF FIGURES

FIGURE 3.1 - PINOUT DIAGRAM .....	8
FIGURE 5.1 - USB2.0 SYSTEM BLOCK DIAGRAM.....	54
FIGURE 5.2 - FUNCTION BLOCK DIAGRAM.....	54
FIGURE 8.1 - GL842 128 PIN QFP PACKAGE.....	64

## LIST OF TABLES

TABLE 3.1 - PIN LIST .....	9
TABLE 3.2 - PIN DESCRIPTIONS.....	10
TABLE 4.1 - BASE ADDRESS FOR REGISTERS.....	14
TABLE 4.2 - SHADING MAPPING (CHUNKY FOR SINGLE BANK) .....	52
TABLE 4.3 - SHADING MAPPING (PLANER).....	52
TABLE 4.4 - SLOPE CURVE TABLE MAPPING .....	53
TABLE 4.5 - IMAGE BUFFER MAPPING.....	53
TABLE 7.1 - ABSOLUTE MAXIMUM RATINGS (VOLTAGE REFERENCED TO GND) .....	62
TABLE 7.2 - DC CHARACTERISTICS (DIGITAL PINS): 3.3 V LOGIC CORE OR PADS .....	62
TABLE 7.3 - DC CHARACTERISTICS (DIGITAL PINS): 5.0 V PADS .....	63
TABLE 7.4 - DC CHARACTERISTICS (D+/D-).....	63



### CHAPTER 1 GENERAL DESCRIPTION

Genesys Logic's single-chip GL842 (GeneScan™ series) is a high speed, high performance, low cost and rich scalability controller for scanner. It successfully integrates scanner function ASIC and USB 2.0 interface controller into one single-chip.

With its high performance design architecture, GL842 is not only ready for supporting CIS or CCD image sensors (600dpi,1200dpi or 2400dpi resolution) that are used in flatbed or transparency scanners, but is able to co-work with uni-polar or bi-polar stepping motors. Advanced features of GL842 include five motor acceleration/ deceleration curve tables for high speed motor moving.



### CHAPTER 2 FEATURES

- Highly integrated scanner controller chip. (2-in-1; Scanner Controller and USB 2.0 Interface)
- USB 2.0 High Speed (480Mbit) compliance. (USB 2.0 High Speed logo certified)
- Design for sheetfed, flatbed and transparency scanner.
- 12MHz Low frequency clock input required for better EMI.
- Flexible 3.3V/5V power selection for pad I/O.
- Adjustable working speed for different usage.
- Fast operation speed. (0.3us/pixel. in 40MHz working clock)
- It costs only 12 seconds for 600dpi A4 size color scanning.
- Available sensor types: 600, 1200 and 2400dpi color CIS or CCD.
- Support linear or stagger CCD, such as NEC, Toshiba or Sony CDD.
- Support 48-Bits color (16-Bits gray level) scanning.
- Support color, fine Gray, fast gray and fast B/W scan for CDD.
- Support color, gray, true gray and B/W scan for CIS.
- Support three scanning types: pixel by pixel (pixel rate), line by line (line rate) and RGB line by turns (line rate).
- 16 bits white/dark shading and 16-to-8 bits Gamma correction.
- Support digital average and hardware deletion pixel function for speeding up low resolution scan.
- Support hardware deletion type for DPI function (2400 to 1 DPI, 1 DPI decrement).
- Programmable threshold level for B/W.
- Exposure time is adjustable (1 pixel time increment step).
- Scan width (scan area) control for horizontal line (1 pixel increment step).
- Support 256K\*16, 256K\*16\*2 and 1M\*16 bits EDO-DRAM.
- Support 5 acceleration/deceleration motor tables for detailed controllable high speed motor moving.
- Support controllable bipolar motor in full, half and quarter steps moving.
- Support controllable uni-polar motor in full and half steps moving.
- Build-in PWM control phase for uni-polar motor.
- Programmable dummy lines to resolve start/stop (discontinuous) problem.
- Watch dog protect for lamp, motor and ASIC.
- Lamp timeout (sleeping) control.
- Support 16 GPIO pins and 2 GPO pins.
- Output motor trigger signal under scanning for ADF.
- 2 Output ports for lamp (include flatbed and transparency with PWM) control.
- Input port for home sensor.
- Power on check status.
- Support LED Blinking.
- Support Back Scanning.

## CHAPTER 3 PIN ASSIGNMENT

### 3.1 Pinouts

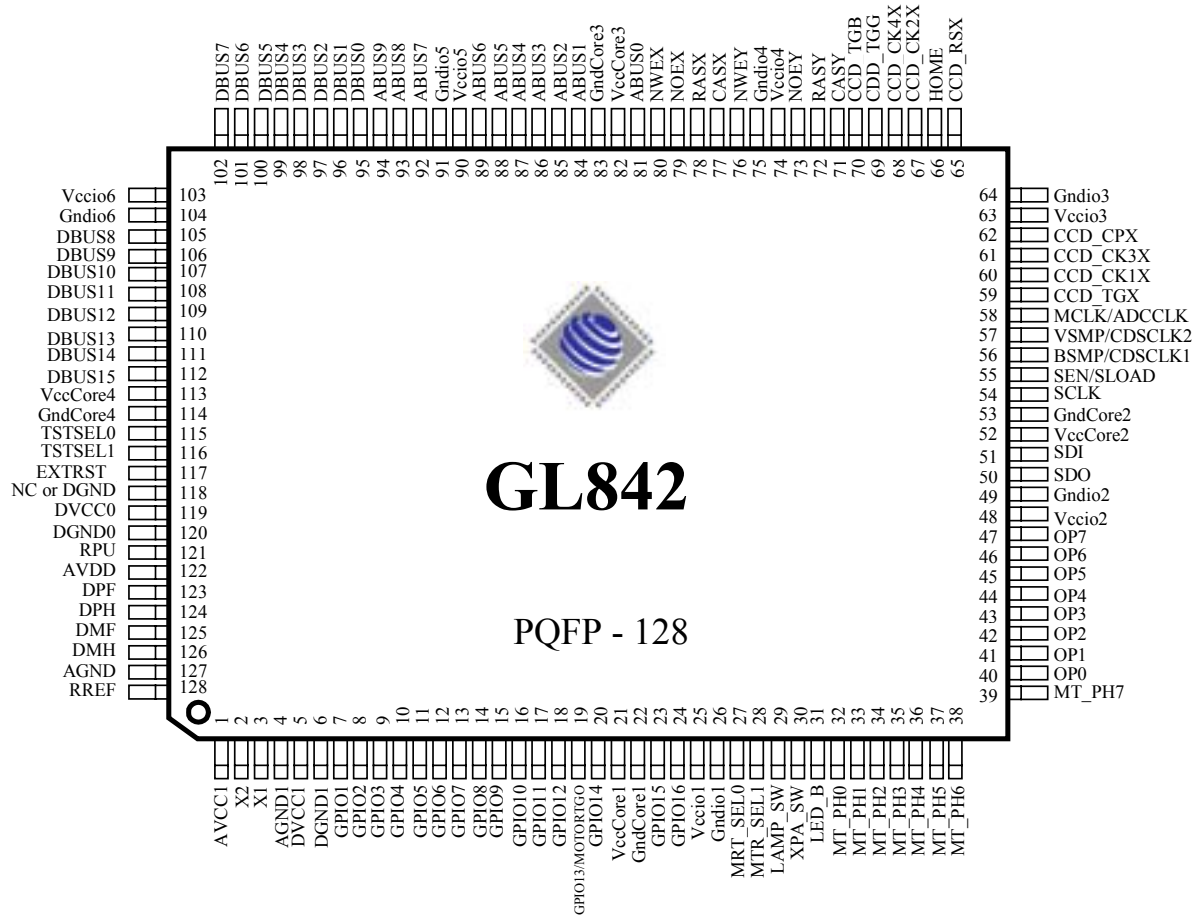

Figure 3.1 - Pinout Diagram





### 3.2 Pin List

Table 3.1 - Pin List

Pin#	Pin Name	Type	Pin#	Pin Name	Type	Pin#	Pin Name	Type	Pin#	Pin Name	Type
1	AVCC1	P	33	MT_PH1	O	65	CCD_RSX	O	97	DBUS2	B
2	X2	I/O	34	MT_PH2	O	66	HOME	I	98	DBUS3	B
3	X1	I	35	MT_PH3	O	67	CCD_CK2X	O	99	DBUS4	B
4	AGND1	P	36	MT_PH4	O	68	CCD_CK4X	O	100	DBUS5	B
5	DVCC1	P	37	MT_PH5	I/O	69	CCD_TGG	O	101	DBUS6	B
6	DGND1	P	38	MT_PH6	O	70	CCD_TGB	O	102	DBUS7	B
7	GPIO1	B	39	MT_PH7	O	71	CASY	O	103	Vccio6	P
8	GPIO2	B	40	OP0	I	72	RASY	O	104	Gndio6	P
9	GPIO3	B	41	OP1	I	73	NOEY	O	105	DBUS8	B
10	GPIO4	B	42	OP2	I	74	Vccio4	P	106	DBUS9	B
11	GPIO5	B	43	OP3	I	75	Gndio4	P	107	DBUS10	B
12	GPIO6	B	44	OP4	I	76	NWEY	O	108	DBUS11	B
13	GPIO7	B	45	OP5	I	77	CASX	O	109	DBUS12	B
14	GPIO8	B	46	OP6	I	78	RASX	O	110	DBUS13	B
15	GPIO9	B	47	OP7	I	79	NOEX	O	111	DBUS14	B
16	GPIO10	B	48	Vccio2	P	80	NWEX	O	112	DBUS15	B
17	GPIO11	B	49	Gndio2	P	81	ABUS0	O	113	VccCore4	P
18	GPIO12	B	50	SDO	I	82	VccCore3	P	114	GndCore4	P
19	GPIO13/ MOTORTGO	B	51	SDI	O	83	GndCore3	P	115	TSTSEL0	I
20	GPIO14	B	52	VccCore2	P	84	ABUS1	O	116	TSTSEL1	I
21	VccCore1	P	53	GndCore2	P	85	ABUS2	O	117	EXTRST_	I
22	GndCore1	P	54	SCLK	O	86	ABUS3	O	118	NC or DGND	P
23	GPIO15	B	55	SEN/SLOAD	O	87	ABUS4	O	119	DVCC0	P
24	GPIO16	B	56	BSMP/ CDSCLK1	O	88	ABUS5	O	120	DGND0	P
25	Vccio1	P	57	VSMP/ CDSCLK2	O	89	ABUS6	O	121	RPU	-
26	Gndio1	P	58	MCLK/ ADCCLK	O	90	Vccio5	P	122	AVDD	P
27	MTR_SEL0	I	59	CCD_TGX	O	91	Gndio5	P	123	DPF	I/O
28	MTR_SEL1	I	60	CCD_CK1X	O	92	ABUS7	O	124	DPH	I/O
29	LAMP_SW	O	61	CCD_CK3X	O	93	ABUS8	O	125	DMF	I/O
30	XPA_SW	O	62	CCD_CPX	O	94	ABUS9	O	126	DMH	I/O
31	LED_B	O	63	Vccio3	P	95	DBUS0	B	127	AGND	P
32	MT_PH0	O	64	Gndio3	P	96	DBUS1	B	128	RREF	-

### 3.3 Pin Descriptions

**Table 3.2 - Pin Descriptions**

Support IO Ports Interface				
Pin Name	Pin#	Type	ASIC I/O Cell	Description
GPIO1~16	7~20,23,24	B	hbd16rsc	General Purpose Input/Output
MT_PH0~4	32~36	O (pd)	hbd16dhk	Bi-polar (3955): MT_PH7=PHASE_A MT_PH6=PHASE_B MT_PH5=D2A MT_PH4=D1A MT_PH3=D0A MT_PH2=D2B MT_PH1=D1B MT_PH0=D0B Bi-polar (2916 or 6219): MT_PH5=PHASE1 MT_PH4=PHASE2 MT_PH3=I11 MT_PH2=I01 MT_PH1=I12 MT_PH0=I02
MT_PH5~7	37~39	O	hbd16rsc	Uni-polar(2003): MT_PH3=PHASE A MT_PH2=PHASE B MT_PH1=PHASE /A MT_PH0=PHASE /B
MOTORTGO/ GPIO13	19	O	hbd16rsc	Output motor trigger for ADF scanning or GPIO13
HOME	66	I (pu)	hbd16uhk	Sense carriage home position

CCD/CIS Control Signals Interface				
Pin Name	Pin#	Type	ASIC I/O Cell	Description
CCD_CK1X	60	O	hbd16rsc	CCD Shift register clock1 or CIS clock output
CCD_CK2X	67	O	hbd16rsc	CCD Shift register clock2 or CIS clock output
CCD_CPX	62	O	hbd16rsc	CCD Clamp gate clock or CIS clock output
CCD_RSX	65	O	hbd16rsc	CCD Reset gate clock or CIS clock output
CCD_TGX	59	O	hbd16rsc	CCD Transfer gate clock for R channel or CIS Line start pulse
CCD_TGG	69	O	hbd16rsc	CCD Transfer gate clock for G channel
CCD_TGB	70	O	hbd16rsc	CCD Transfer gate clock for B channel
CCD_CK3X	61	O	hbd16rsc	CCD Shift register clock3
CCD_CK4X	68	O	hbd16rsc	CCD Shift register clock4
LAMP_SW	29	O	hbd16rsc	Flatbed lamp power control or CIS Red LED array control



XPA_SW	30	O	hbd16rsc	Transparency lamp power control or CIS Green LED array control
LED_B	31	O	hbd16rsc	CIS Blue LED array control

FRONT-END Interface				
Pin Name	Pin#	Type	ASIC I/O Cell	Description
OP0~7	40~47	I (pd)	hbd16dhk	AFE digital data input
SEN/SLOAD	55	O (pd)	hbd16dhk	Serial interface load pulse
SCLK	54	O	hbd16rsc	Serial interface clock output
SDI	51	O (pd)	hbd16dhk	Serial data output
SDO	50	I (pd)	hbd16dhk	Serial data input
BSMP/CDSCLK1	56	O	hbd16rsc	Wolfson type: Video sample synchronization pulse Analog Device: CDS Reference level sampling clock
VSMP/CDSCLK2	57	O	hbd16rsc	Wolfson type: Video sample synchronization pulse Analog Device: CDS Data level sampling clock
MCLK/ADCCLK	58	O	hbd16rsc	Wolfson type: Master clock. Analog Device: A/D Converter sampling clock.

DRAM Interface				
Pin Name	Pin#	Type	ASIC I/O Cell	Description
DBUS0~15	95~102, 105~112	B (pd)	hbd16dhk	DRAM data bus
ABUS0~9	81,84~89, 92~94	O (pd)	hbd16dhk	DRAM address bus
RASX	78	O (pd)	hbd16dhk	DRAM RAS signal of first memory chip
CASX	77	O (pd)	hbd16dhk	DRAM CAS signal of first memory chip
NOEX	79	O (pd)	hbd16dhk	DRAM OE(output enable) signal of first memory chip
NWEX	80	O (pd)	hbd16dhk	DRAM WE signal of first memory chip
RASY	72	O (pd)	hbd16dhk	DRAM RAS signal of second memory chip
CASY	71	O (pd)	hbd16dhk	DRAM CAS signal of second memory chip
NOEY	73	O (pd)	hbd16dhk	DRAM OE(output enable) signal of second memory chip
NWEY	76	O (pd)	hbd16dhk	DRAM WE signal of second memory chip

Miscellaneous				
Pin Name	Pin#	Type	ASIC I/O Cell	Description
TSTSEL[1:0]	116,115	I (pd)	hbd16dhk	To select mode: Normal mode=0
MTR_SEL[1:0]	28,27	I (pd)	hbd16dhk	MTR_SEL[1:0]=10 select Bi_polar 3955 MTR_SEL[1:0]=01 select Bi_polar 2916 OR 6219 MTR_SEL[1:0]=00 select Uni_polar 2003
X1	3	I	-	Clock input for crystal (12MHz)
X2	2	I/O	-	Clock output for crystal
EXTRST_	117	I	Hbd8rteu	Hardware reset input

USB Interface				
Pin Name	Pin#	Type	ASIC I/O Cell	Description
NC or DGND	118	P	-	NC or USB shield ground
RPU	121	-	-	3.3V Pull up control for DPF
DPF	123	I/O	-	Positive USB differential data (Full Speed)
DPH	124	I/O	-	Positive USB differential data (High Speed)
DMF	125	I/O	-	Negative USB Differential Data (Full Speed)
DMH	126	I/O	-	Negative USB Differential Data (High Speed)
RREF	128	-	-	510 $\Omega$ reference resistor input

Power / Ground				
Pin Name	Pin#	Type	ASIC I/O Cell	Description
AVDD, AVCC1	122,1	P	-	Analog power input for USB2.0 transceiver 3.3V
AGND, AGND1	127,4	P	-	Analog ground input for USB2.0 transceiver
DVCC0, DVCC1	119,5	P	-	Digital power input for USB2.0 controller 3.3V
DGND0, DGND1	120,6	P	-	Digital ground input for USB2.0 controller.
VccCore1~4	21,52,82,113	P	-	Digital power input for scanner controller logic core 3.3V
GndCore1~4, Gndio1~6	22,53,83,114,26,49,64,75,91,104	P	-	Digital ground input for scanner controller.
Vccio1	25	P	-	For Pin7~Pin39 3.3V or 5V
Vccio2	48	P	-	For Pin40~Pin58 3.3V or 5V
Vccio3	63	P	-	For Pin59~Pin66 3.3V or 5V
Vccio4~6	74,90,103	P	-	For Pin67~116 3.3V or 5V

Note: hbd16\* is for 6mA; hbd8\* is for 8mA.



**Notation:**

<b>Type</b>	<b>O</b>	Output
	<b>I</b>	Input
	<b>B</b>	Bi-directional
	<b>B/I</b>	Bi-directional, default input
	<b>B/O</b>	Bi-directional, default output
	<b>P</b>	Power / Ground
	<b>A</b>	Analog
	<b>SO</b>	Automatic output low when suspend
	<b>pu</b>	Internal pull up
	<b>pd</b>	Internal pull down
	<b>odpu</b>	Open drain with internal pull up

## CHAPTER 4 REGISTERS

### 4.1 Registers Base Address

**Table 4.1 - Base Address for Registers**

Offset (Hex)	Bit 7	Bit 6	Bit 5	Bit 4	Bit 3	Bit 2	Bit 1	Bit 0	Default
01h	CISSET	DOGENB	DVDSET	X	M16DRAM	DRAMSEL	SHDAREA	SCAN	8'h00
02h	NOTHOME	ACDCDIS	AGOHOME	MTRPWR	FASTFED	MTRREV	HOMENEG	LONGCURV	8'h00
03h	LAMPDOG	AVEENB	XPASEL	LAMPPWR	LAMPTIM[3:0]				8'h0C
04h	LINEART	BITSET	AFEMOD[1:0]		FILTER[1:0]		FESET[1:0]		8'h00
05h	DPIHW[1:0]		MTLLAMP[1:0]		GMMENB	X	MTLBASE[1:0]		8'h00
06h	SCANMOD[2:0]			PWRBIT	GAIN4	OPTTEST[2:0]			8'h00
07h	X	X	X	X	SRAMSEL	FASTDMA	DMASEL	DMARDWR	8'h00
08h	X	DECFLAG	GMMFFR	GMMFFG	GMMFFB	GMMZR	GMMZG	GMMZB	8'h00
09h	MCNTSET[1:0]		CLKSET[1:0]		BACKSCAN	ENHANCE	SHORTTG	NWAIT	8'h00
0Ah	X	X	X	X	X	X	X	SRAMBUF	8'h00
0Bh	X	X	X	X	X	X	X	X	-
0Ch	X	X	X	X	X	X	X	X	-
0Dh	X	X	X	X	X	X	X	CLRLNCNT	-
0Eh	SCANRESET								-
0Fh	MOVE								-
10h	EXPR15	EXPR14	EXPR13	EXPR12	EXPR11	EXPR10	EXPR9	EXPR8	8'h00
11h	EXPR7	EXPR6	EXPR5	EXPR4	EXPR3	EXPR2	EXPR1	EXPR0	8'h00
12h	EXPG15	EXPG14	EXPG13	EXPG12	EXPG11	EXPG10	EXPG9	EXPG8	8'h00
13h	EXPG7	EXPG6	EXPG5	EXPG4	EXPG3	EXPG2	EXPG1	EXPG0	8'h00
14h	EXPB15	EXPB14	EXPB13	EXPB12	EXPB11	EXPB10	EXPB9	EXPB8	8'h00
15h	EXPB7	EXPB6	EXPB5	EXPB4	EXPB3	EXPB2	EXPB1	EXPB0	8'h00
16h	CTRLHI	TOSHIBA	TGINV	CK1INV	CK2INV	CTRLINV	CKDIS	CTRLDIS	8'h32
17h	TGMODE[1:0]		TGW[5:0]						8'h14
18h	CNSET	DCKSEL[1:0]		CKTOGGLE	CKDELAY[1:0]		CKSEL[1:0]		8'h00
19h	EXPDMY[7:0]								8'h00
1Ah	X	X	MANUAL3	MANUAL1	CK4INV	CK3INV	LINECLP	X	8'h00
1Bh	X	X	X	X	X	X	X	X	-
1Ch	CK4MTGL	CK3MTGL	CK1MTGL	CKAREA	MTLWD	TGTIME[2:0]			8'h00
1Dh	CK4LOW	CK3LOW	CK1LOW	TGSGLD[4:0]					8'h04
1Eh	WDTIME[3:0]				LINESEL[3:0]				8'h20
1Fh	SCANFED[7:0]								8'h00
20h	BUFSEL[7:0]								8'h00
21h	STEPNO[7:0]								8'h00
22h	FWDSTEP[7:0]								8'h00
23h	BWDSTEP[7:0]								8'h00
24h	FASTNO[7:0]								8'h00
25h	X	X	X	X	LINCNT[19:16]				8'h00
26h	LINCNT[15:8]								8'h00



27h	LINCNT[7:0]								8'h00
28h	"GMMWRDATA"								8'h00
29h	LAMPPWM[7:0]								8'h00
2Ah	RAMADDR[15:8]								8'h00
2Bh	RAMADDR[7: 0]								8'h00
2Ch	X	X	X	X	DPISET[11:8]			8'h00	
2Dh	DPISET[7:0]								8'h00
2Eh	BWHI[7:0]								8'h00
2Fh	BWLOW[7:0]								8'h00
30h	STRPIXEL[15:8]								8'h00
31h	STRPIXEL[7:0]								8'h00
32h	ENDPIXEL[15:8]								8'h00
33h	ENDPIXEL[7:0]								8'h00
34h	DUMMY[7:0]								8'h00
35h	X	X	X	X	MAXWD[19:16]			8'h00	
36h	MAXWD[15:8]								8'h00
37h	MAXWD[7:0]								8'h00
38h	LPERIOD[15:8]								8'h15
39h	LPERIOD[7:0]								8'h18
3Ah	X	X	X	X	X	X	X	FEWRDATA8	8'h00
3Bh	FEWRDATA[7:0]								8'h00
3Ch	"RAMWRDATA"								8'h00
3Dh	X	X	X	X	FEEDL[19:16]			8'h00	
3Eh	FEEDL[15:8]								8'h00
3Fh	FEEDL[7:0]								8'h00
40h						HISPDFL	MOTMFL	DATAEN	-
41h	PWRBIT	BUFEMP	FEEDFS	SCANFS	HOMESN	LAMPST	FEBUSY	MOTORE	-
42h	X	X	X	X	VALIDWORD[19:16]			-	
43h	VALIDWORD[15:8]								-
44h	VALIDWORD[7:0]								-
45h	"RAMRDDATA"								-
46h	X	X	X	X	X	X	X	FERDDATA8	-
47h	FERDDATA[7:0]								-
48h	X	X	X	X	FEDCNT[19:16]			-	
49h	FEDCNT[15:8]								-
4Ah	FEDCNT[7:0]								-
4Bh	X	X	X	X	SCANCNT[19:16]			-	
4Ch	SCANCNT[15:8]								-
4Dh	SCANCNT[7:0]								-
4Eh	"GMMRDDATA"								-
4Fh	X	X	X	X	X	X	X	X	-
50h	X	X	FERDA[5:0]					8'h00	
51h	X	X	FEWRA[5:0]					8'h00	
52h				RHI[4:0]				8'h00	
53h				RLOW[4:0]				8'h00	



## GL842 USB 2.0 2-in-1 Scanner Controller

54h					GHI[4:0]				8'h00
55h					GLOW[4:0]				8'h00
56h					BHI[4:0]				8'h00
57h					BLOW[4:0]				8'h00
58h	VSMP[4:0]				VSMPW[2:0]				8'h00
59h	BSMP[4:0]				BSMPW[2:0]				8'h00
5Ah	ADCLKINV	RLCSEL	CDSREF[1:0]		RLC[3:0]				8'hC0
5Bh	X	X	X	X	X	X	GMMADDR[9:8]		8'h00
5Ch	GMMADDR[7:0]								8'h00
5Dh	HISPD[7:0]								8'h00
5Eh	DECSEL[2:0]			STOPTIM[4:0]					8'h00
5Fh	FMOVDEC[7:0]								8'h00
60h	X	X	X	Z1MOD[20:16]				8'h00	
61h	Z1MOD[15:8]								8'h00
62h	Z1MOD[7:0]								8'h00
63h	X	X	X	Z2MOD[20:16]				8'h00	
64h	Z2MOD[15:8]								8'h00
65h	Z2MOD[7:0]								8'h00
66h	PHFREQ[7:0]								8'h00
67h	STEPSEL[1:0]		MTRPWM[5:0]					8'h7F	
68h	FSTPSEL[1:0]		FASTPWM[5:0]					8'h7F	
69h	FSHDEC[7:0]								8'h00
6Ah	FMOVNO[7:0]								8'h00
6Bh	MULTFIL	GPOM13	GPOM12	GPOM11	X	X	GPO18	GPO17	8'h00
6Ch	GPIO16	GPIO15	GPIO14	GPIO13	GPIO12	GPIO11	GPIO10	GPIO9	8'h00
6Dh	GPIO8	GPIO7	GPOI6	GPIO5	GPIO4	GPIO3	GPIO2	GPIO1	8'h00
6Eh	GPOE16	GPOE15	GPOE14	GPOE13	GPOE12	GPOE11	GPOE10	GPOE9	8'h00
6Fh	GPOE8	GPOE7	GPOE6	GPOE5	GPOE4	GPOE3	GPOE2	GPOE1	8'h00
70h	X	X	X	RSH[4:0]				8'h15	
71h	X	X	X	RSL[4:0]				8'h17	
72h	X	X	X	CPH[4:0]				8'h15	
73h	X	X	X	CPL[4:0]				8'h17	
74h	X	X	X	X	X	X	CK1MAP[17:16]		8'h00
75h	CK1MAP[15:8]								8'h00
76h	CK1MAP[7:0]								8'h00
77h	X	X	X	X	X	X	CK3MAP[17:16]		8'h00
78h	CK3MAP[15:8]								8'h00
79h	CK3MAP[7:0]								8'h00
7Ah	X	X	X	X	X	X	CK4MAP[17:16]		8'h00
7Bh	CK4MAP[15:8]								8'h00
7Ch	CK4MAP[7:0]								8'h00
7Dh	CK1NEG	CK3NEG	CK4NEG	RSNEG	CPNEG	BSMPNEG	VSMPNEG	DLYSET	8'h00
7Eh	X	X	GPOLED	GPOLED	GPOLED	GPOLED	GPOLED	GPOLED	8'h00
7Fh	BSMPDLY[1:0]		VSMPDLY[1:0]		LEDCNT[3:0]			8'h00	
80h	VRHOME[1:0]		VRMOVE[1:0]		VRBACK[1:0]		VRSCAN[1:0]		8'h00





81h	X	X	X	X	X	X	X	ROFFSET8	8'h00
82h	ROFFSET[7:0]								8'h00
83h	X	X	X	X	X	X	X	GOFFSET	8'h00
84h	GOFFSET[7:0]								8'h00
85h								BOFFSET	8'h00
86h	BOFFSET[7:0]								8'h00
87h	X	YENB	YBIT	ACYCNRLC	ENOFFSET	LEDADD	CK4ADC	AUTOCONF	8'h00

**Notation:**

- R/W**                 Read / Write
- R/O**                 Read Only
- W/O**                 Write Only
- R/W1C**             Readable and Write-1-Clear
- R/W/C**             Read / Write and hardware automatic Clear



## 4.2 Register Descriptions

**Offset 01h ..... Default value = 8'h00**

CISSET	DOGENB	DVDSET	X	M16DRAM	DRAMSEL	SHDAREA	SCAN
R/W	R/W	R/W	X	R/W	R/W	R/W	R/W

- 7 **CISSET**      0 CCD scan type.  
                  1 CIS scan type.
- 6 **DOGENB**     0 Disable.  
                  1 Enable watch dog of ASIC(set time out:Reg1E[7:4]).
- 5 **DVDSET**      0 Disable shading  
                  1 Enable shading (include whole line shading and area shading two kinds).
- 4 **RESERVED**    -
- 3 **M16DRAM**    0 To select 4M or 8M bits DRAM(256\*16).  
                  1 To select 16M bits DRAM (1M \* 16).
- 2 **DRAMSEL**    0 The DRAM size is 4Mx1(256kx16x1) bits.  
                  1 The DRAM size is 4Mx2 (256kx16x2) bits.
- 1 **SHDAREA**     0 Shading area is whole line.  
                  1 Enable shading area (depend on scan area and scan dpi).
- 0 **SCAN**        0 Disable scan process.  
                  1 Enable scan process.

**Offset 02h ..... Default value = 8'h00**

NOTHOME	ACDCDIS	AGOHOME	MTRPWR	FASTFED	MTRREV	HOMENEG	LONGCURV
R/W	R/W	R/W	R/W	R/W	R/W	R/W	R/W

- 7 **NOTHOME**    0 Go back to home position automatically.  
                  1 Auto-go-home doesn't go back to home position.
- 6 **ACDCDIS**    0 Enable forward/backward moving whenever buffer full.  
                  1 Disable forward/backward moving whenever buffer full.
- 5 **AGOHOME**    0 Disable auto-go-home fcnction.  
                  1 Whenever scan is finished, carriage go home automatically.
- 4 **MTRPWR**     0 Turn off MOTOR power and phase.  
                  1 Turn on MOTOR power and phase.
- 3 **FASTFED**    0 Disable two table, only use single table.  
                  1 Enable two table for motor moving of the acceleration/deceleration.
- 2 **MTRREV**     0 Set motor forward moving.  
                  1 Set motor reverse moving.
- 1 **HOMENEG**    0 To indicate whenever home sensor change from low to high (rising edge) then motor is decelerated.  
                  1 To indicate whenever home sensor change from high to low (falling edge) then motor is decelerated.
- 0 **LONGCURV**  0 The deceleration curve of the fast moving is table 4.  
                  1 The deceleration curve of the fast moving is table 5.



**Offset 03h ..... Default value = 8'h0C**

LAMPDOG	AVEENB	XPASEL	LAMPPWR	LAMPTIM3	LAMPTIM2	LAMPTIM1	LAMPTIM0
R/W	R/W	R/W	R/W	R/W	R/W	R/W	R/W

- 7 **LAMPDOG** 0 To disable lamp sleeping mode.  
1 To start lamp sleeping mode(default on).
- 6 **AVEENB** 0 Select dpi deletion function  
1 Select dpi average function.
- 5 **XPASEL** 0 Select flatbed lamp on.  
1 Select transparency lamp on.
- 4 **LAMPPWR** 0 Turn off LAMP power.  
1 Turn on LAMP power.
- 3-0 **LAMPTIM[3:0]** Lamp on time setting (default: 4).  
The unit is minute.

**Offset 04h ..... Default value = 8'h00**

LINEART	BITSET	AFEMOD1	AFEMOD0	FILTER1	FILTER0	FESET1	FESET0
R/W	R/W	R/W	R/W	R/W	R/W	R/W	R/W

- 7 **LINEART** 0 Color/Gray scan.  
1 Black/White scan.
- 6 **BITSET** 0 8 bits image data type (= byte).  
1 16 bits image data type (= word).
- 5-4 **AFEMOD[1:0]** To indicate AFE operation mode.

Wolfson Type					
AFEMOD	SCANMOD	Description	CDS Available	Max Sample Rate	Timing Requirements
2	2	Slow color Pixel-by-pixel	Yes	5MSPS *3 channel	MCLK:VSMP Rate is 8:1
1	0,1,3,4,5,6	Color pixel-by-pixel	Yes	6.67MSPS *3 channel	MCLK:VSMP Rate is 6:1
0	0,1,4,5,6	Fast Mono	Yes	13.3MSPS *1 channel	MCLK:VSMP Rate is 3:1
Analog Device Type					
AFEMOD	SCANMOD	Description	CDS Available	Max Sample Rate	Timing Requirements
2	0,1,4,5,6	Slow color Pixel-by-pixel	Yes		MCLK:VSMP Rate is 3:1
1	0,1,2,3,4,5,6	Mono	Yes		MCLK:VSMP Rate is 2:1
0	0,1,2,3,4,5,6	Fast Mono	Yes		MCLK:VSMP Rate is 1:1

- 3-2 **FILTER[1:0]** Scan color type:  
00 Color  
01 R  
10 G  
11 B
- 1-0 **FESET[1:0]** Front end operation type:  
00 ESIC type 1  
01 ESIC type2  
10 ADI type  
11 Reserved



**Offset 05h ..... Default value = 8'h00**

DPIHW1	DPIHW0	MTLLAMP1	MTLLAMP0	GMMENB	X	MTLBASE1	MTLBASE0
R/W	R/W	R/W	R/W	R/W	X	R/W	R/W

- 7-6 DPIHW[1:0]** To set CCD/CIS resolution.
  - 00 600 dpi
  - 01 1200 dpi
  - 10 2400 dpi
  - 11 Reserved
- 5-4 MTLAMP[1:0]** To set times of the lamp time out.
  - 00 1\* LAMPTIM
  - 01 2\* LAMPTIM
  - 10 4\* LAMPTIM
  - 11 Reserved
- 3 GMMENB** 0 Bypass gamma correction.  
1 Enable gamma correction.
- 2 RESERVED** -
- 1-0 MTLBASE[1:0]** To set output CCD pixel number under each system pixel time.
  - 00 1 CCD pixel/sstem pixel time.
  - 01 2 CCD pixel/sstem pixel time.
  - 10 3 CCD pixel/sstem pixel time.
  - 11 4 CCD pixel/sstem pixel time.

**Offset 06h ..... Default value = 8'h00**

SCANMOD2	SCANMOD1	SCANMOD0	PWRBIT	GAIN4	OPTTEST2	OPTTEST1	OPTTEST0
R/W	R/W	R/W	R/W	R/W	R/W	R/W	R/W

- 7-5 SCANMOD[2:0]** To set operation mode.
  - 000 12 clocks/pixel ; normal mode operation for scanning.  
Include color(pixel rate),fine gray and fine line-art.
  - 001 12 clocks/pixel ; bypass mode operation for calibration.  
Include color(pixel rate) and fine gray.
  - 010 Reserved
  - 011 Reserved
  - 100 6 clocks/pixel ; fast mode operation.  
Include color(line rate),fast gray and fast line-art.
  - 101 15 clocks/pixel ; for 16 bits color output.
  - 110 18 clocks/pixel ; for 16 bits color output.
  - 111 Reserved
- 4 PWRBIT** When power on,set this bit.To indicate power has on. Default is reset.
- 3 GAIN4** 0 Digital shading gain=8 times system.  
1 Digital shading gain=4 times system.  
Note: If you want to get more precise image quality,you can set GAIN4 bit.
- 2-0 OPTTEST[2:0]** Select ASIC operation type.
  - 000 Set normal mode to capture AFE image.
  - 001 Set DRAM bank,power on carriage initiated and ADF(motortgo) test for ASIC simulation.
  - 010 Pixel count pattern for ASIC image test.
  - 011 Line count pattern for ASIC image test.
  - 100 Counter and adder test for ASIC simulation test.
  - 101 Reserved.
  - 110 Reserved.
  - 111 Reserved.



**Offset 07h ..... Default value = 8'h00**

X	X	X	X	SRAMSEL	FASTDMA	DMASEL	DMARDWR
X	X	X	X	R/W	R/W	R/W	R/W

- 7-4 **RESERVED** -
- 3 **SRAMSEL** 0 DMA access for DRAM.  
1 DMA access for SRAM.
- 2 **FASTDMA** 0 4clocks/access, that is to say 4clocks/16bits or 4clocks/8bits for DMA access.  
1 2clocks/access, that is to say 2clocks/16bits or 2clocks/8bits for DMA access.
- 1 **DMASEL** 0 MPU access DRAM under command mode.  
1 DMA access DRAM under command mode.
- 0 **DMARDWR** 0 DMA write DRAM under command mode.  
1 DMA read DRAM under command mode.

Note: DMA operation can be processed under CPU and DMA type.

**Offset 08h ..... Default value = 8'h00**

X	DECFLAG	GMMFFR	GMMFFG	GMMFFB	GMMZR	GMMZG	GMMZB
X	R/W	R/W	R/W	R/W	R/W	R/W	R/W

- 7 **RESERVED** -
- 6 **DECFLAG** 0 Gamma table is increment type  
1 Gamma table is decrement type.
- 5 **GMMFFR** To indicate that red channel Gamma table address FFH is special value.
- 4 **GMMFFG** To indicate that red channel Gamma table address FFH is special value.
- 3 **GMMFFB** To indicate that red channel Gamma table address FFH is special value.
- 2 **GMMZR** To indicate that red channel Gamma table address 00H is special value.
- 1 **GMMZG** To indicate that green channel Gamma table address 00H is special value.
- 0 **GMMZB** To indicate that blue channel Gamma table address 00H is special value.

**Offset 09h ..... Default value = 8'h00**

MCNTSET1	MCNTSET0	CLKSET1	CLKSET0	BACKSCAN	ENHANCE	SHORTTG	NWAIT
R/W	R/W	R/W	R/W	R/W	R/W	R/W	R/W

- 7-6 **MCNTSET[1:0]** To select the unit of motor table counter.  
00 Pixel count.  
01 System clock\*2.  
10 System clock\*3.  
11 System clock\*4.
- 5-4 **CLKSET[1:0]** To select the system clock frequency.  
00 24 MHz  
01 30 MHz  
10 40 MHz  
11 48 MHz
- 3 **BACKSCAN** 0 To select forward scan function.  
1 To enable backward scan function.
- 2 **ENHANCE** 0 To select normal EPP interface speed for USB2.0  
1 To enhance EPP interface speed for USB2.0
- 1 **SHORTTG** Enable short CCD SH(TG) period for film scanning.
- 0 **NWAIT** To delay nWait (H\_BUSY) one clock.



**Offset 0Ah ..... Default value = 8'h00**

X	X	X	X	X	X	X	SRAMBUF
X	X	X	X	X	X	X	R/W

**7-1 RESERVED -**

- 0 SRAMBUF** 0 To select external DRAM as the image buffer.
- 1 To select external SRAM as the image buffer.

**Offset 0Dh**

X	X	X	X	X	X	X	CLRLNCNT
X	X	X	X	X	X	X	W

Command: Scanner command.

**7-1 RESERVED -**

- 0 CLRLNCNT** 0 Don't clear SCANCNT.
- 1 To clear SCANCNT(Reg4B,Reg4C,Reg4D).

Note: For each time scanning , you must clear SCANCNT before starting process.

**Offset 0Eh**

SCANRESET							
W							

Command: Scanner software reset.

It can initiate AISC system, including lamp and motor, control registers, internal circuit and status, but not including tables in DRAM, like gamma table, shading table and acceleration/deceleration table.

Note: In normal condition, it is unnecessary to reset scanner , unless the scanner is out of control.

**Offset 0Fh**

MOVE							
W							

Command: Motor moving.

Start motor forward/backward moving.

**Offset 10h ..... Default value = 8'h00**

EXPR15	EXPR14	EXPR13	EXPR12	EXPR11	EXPR10	EXPR9	EXPR8
R/W	R/W	R/W	R/W	R/W	R/W	R/W	R/W

- 7-0 EXPR[15:8]** Red-LED array of CIS or Red channel TG of CCD exposure time setting.

Note: Can't be programmed to logic zero.



**Offset 11h ..... Default value = 8'h00**

EXPR7	EXPR6	EXPR5	EXPR4	EXPR3	EXPR2	EXPR1	EXPR0
R/W	R/W	R/W	R/W	R/W	R/W	R/W	R/W

**7-0 EXPR[7:0]** Red-LED array of CIS or Red channel TG of CCD exposure time setting.

Note: Can't be programmed to logic zero.

**Offset 12h ..... Default value = 8'h00**

EXPG15	EXPG14	EXPG13	EXPG12	EXPG11	EXPG10	EXPG9	EXPG8
R/W	R/W	R/W	R/W	R/W	R/W	R/W	R/W

**7-0 EXPG[15:8]** Green-LED array of CIS or Red channel TG of CCD exposure time setting.

Note: Can't be programmed to logic zero.

**Offset 13h ..... Default value = 8'h00**

EXPG7	EXPG6	EXPG5	EXPG4	EXPG3	EXPG2	EXPG1	EXPG0
R/W	R/W	R/W	R/W	R/W	R/W	R/W	R/W

**7-0 EXPG[7:0]** Green-LED array of CIS or Red channel TG of CCD exposure time setting.

Note: Can't be programmed to logic zero.

**Offset 14h ..... Default value = 8'h00**

EXPB15	EXPB14	EXPB13	EXPB12	EXPB11	EXPB10	EXPB9	EXPB8
R/W	R/W	R/W	R/W	R/W	R/W	R/W	R/W

**7-0 EXPB[15:8]** Blue-LED array of CIS or Red channel TG of CCD exposure time setting.

Note: Can't be programmed to logic zero.

**Offset 15h ..... Default value = 8'h00**

EXPB7	EXPB6	EXPB5	EXPB4	EXPB3	EXPB2	EXPB1	EXPB0
R/W	R/W	R/W	R/W	R/W	R/W	R/W	R/W

**7-0 EXPB[7:0]** Blue-LED array of CIS or Red channel TG of CCD exposure time setting.

Note: Can't be programmed to logic zero.



**Offset 16h ..... Default value = 8'h32**

CTRLHI	TOSHIBA	TGINV	CK1INV	CK2INV	CTRLINV	CKDIS	CTRLDIS
R/W	R/W	R/W	R/W	R/W	R/W	R/W	R/W

- 7 CTRLHI**      0 CCD CP & RS are low under TG high position.  
                  1 CCD CP & RS are high under TG high position.
- 6 TOSHIBA**    To indicate the image sensor is TOSHIBA CIS.
- 5 TGINV**        0 Don't reverse.  
                  1 To reverse CCD TG.
- 4 CK1INV**      0 Don't reverse.  
                  1 To reverse CCD Clock 1.
- 3 CK2INV**      0 Don't reverse.  
                  1 To reverse CCD Clock 2.
- 2 CTRLINV**     0 Don't reverse.  
                  1 To reverse CCD CP & RS.
- 1 CKDIS**        0 Enable CCD TG position Clock 1/2 signals.

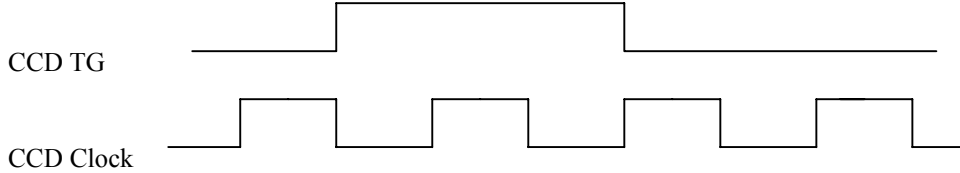

1 Disable CCD TG position Clock 1/2 signals.



- 0 CTRLDIS**     0 Enable CCD TG position CP & RS signals.

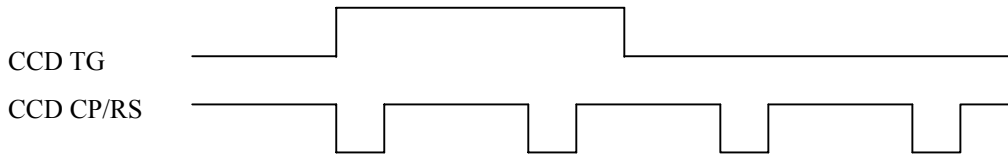

1 Disable CCD TG position CP & RS signals.

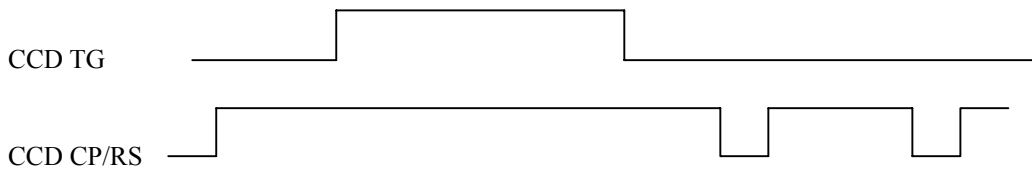





**Offset 17h ..... Default value = 8'h14**

TGMODE1	TGMODE0	TGW5	TGW4	TGW3	TGW2	TGW1	TGW0
R/W	R/W	R/W	R/W	R/W	R/W	R/W	R/W

- 7-6 TGMODE[1:0]** To set CCD TG mode.  
 00 without dummy line CCD TG type.  
 01 with reflectional document scanning type.  
 10 with transparency scanning type.  
 11 TGMODE=2 for simulation.

**5-0 TGW[5:0]** To set CCD TG width.

Note: Can't be programmed to logic zero.

**Offset 18h ..... Default value = 8'h00**

CNSET	DCKSEL1	DCKSEL0	CKTOGGLE	CKDELAY1	CKDELAY0	CKSEL1	CKSEL0
R/W	R/W	R/W	R/W	R/W	R/W	R/W	R/W

- 7 CNSET** 0 TG and clock is non-Canon CIS style.  
 1 TG and clock set to Canon CIS style.
- 6-5 DCKSEL1[1:0]** 00 One time CCD Clocks speed for dummy line.  
 01 Two times CCD Clocks speed for dummy line.  
 10 Three times CCD Clocks speed for dummy line.  
 11 Four times CCD Clocks speed for dummy line.
- 4 CKTOGGLE** 0 One cycle per pixel.  
 1 Half cycle per pixel for CCD Clock 1/2.
- 3-2 CKDELAY[1:0]** 00 No delay  
 01 Delay one system clock for CCD Clock 1/2.  
 10 Delay two systems clock for CCD Clock 1/2.  
 11 Delay three systems clock for CCD Clock 1/2.
- 1-0 CKSEL[1:0]** 00 One time CCD Clock speed for capture image.  
 01 Two times CCD Clock speed for capture image.  
 10 Three times CCD Clock speed for capture image.  
 11 Four times CCD Clock speed for capture image.

Note: CCD Clock speed up limitation :

- |                                  |  |
|----------------------------------|--|
| 1. SCANMOD=0,1 : 12 clocks/pixel | a. toggle CCD : be able to speed up 1,2,3,4 times.<br>b. non-toggle CCD : be able to speed up 1,2,3 times.   |
| 2. SCANMOD=2 : Reserved.         |  |
| 3. SCANMOD=3 : Reserved.         |  |
| 4. SCANMOD=4 : 6 clocks/pixel    | a. toggle CCD : be able to speed up 1,2,3 times.<br>b. non-toggle CCD : can not speed up.                    |
| 5. SCANMOD=5 : 15 clocks/pixel   | a. toggle CCD : be able to speed up 1,2,3,4 times.<br>b. non-toggle CCD : be able to speed up 1,2,3 times.   |
| 6. SCANMOD=6 : 18 clocks/pixel   | a. toggle CCD : be able to speed up 1,2,3,4 times.<br>b. non-toggle CCD : be able to speed up 1,2,3,4 times. |

**Offset 19h ..... Default value = 8'h00**

EXPDMY7	EXPDMY6	EXPDMY5	EXPDMY4	EXPDMY3	EXPDMY2	EXPDMY1	EXPDMY0
R/W	R/W	R/W	R/W	R/W	R/W	R/W	R/W

**7-0 EXPDMY[7:0]** To set dummy line exposure time (unit = 256 pixels time) or CIS LED array turn-on time.

Note: The unit is pixel time.

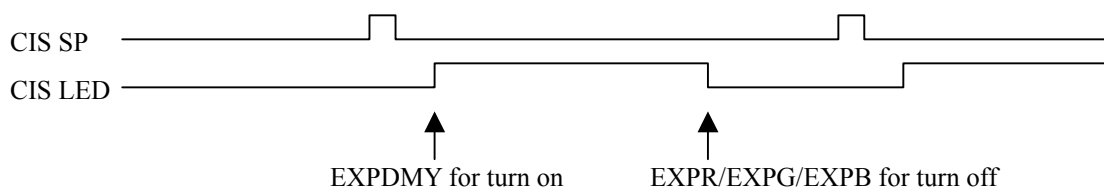

Note: Can not be programmed to logic zero.

**Offset 1Ah ..... Default value = 8'h00**

X	X	MANUAL3	MANUAL1	CK4INV	CK3INV	LINECLP	X
X	X	R/W	R/W	R/W	R/W	R/W	X

- 7-6 RESERVED** -
- 5 MANUAL3**
  - 0 CCD Clock 3,Clock4 automatic output.
  - 1 CCD Clock 3,Clock4 manual output.
- 4 MANUAL1**
  - 0 CCD Clock 1,Clock2 automatic output.
  - 1 CCD Clock 1,Clock2 manual output.
- 3 CK4INV**
  - 0 Don't reverse.
  - 1 To reverse CCD Clock4.
- 2 CK3INV**
  - 0 Don't reverse.
  - 1 To reverse CCD Clock 3.
- 1 LINECLP**
  - 0 To select CCD pixel clamping.
  - 1 To select CCD line clamping.
- 0 RESERVED** -

**Offset 1Ch ..... Default value = 8'h00**

CK4MTGL	CK3MTGL	CK1MTGL	CKAREA	MTLWD	TGTIME2	TGTIME1	TGTIME0
R/W	R/W	R/W	R/W	R/W	R/W	R/W	R/W

- 7 CK4MTGL** To indicate CCD clock 4 to use toggle function.
- 6 CK3MTGL** To indicate CCD clock 3 to use toggle function.
- 5 CK1MTGL** To indicate CCD clock 1 to use toggle function.
- 4 CK3INV**
  - 1 To reverse CCD Clock 3.
- 3 MTLWD** To set double of the watch-dog time out .
- 2-0 TGTIME[2:0]** CCD Line Period selection.
  - 000 1\*LPERIOD(Reg38,Reg39)
  - 001 2\*LPERIOD
  - 010 4\*LPERIOD
  - 011 8\*LPERIOD
  - 100 16\*LPERIOD
  - 101 32\*LPERIOD
  - 110 Reserved.
  - 111 Reserved.



**Offset 1Dh ..... Default value = 8'h04**

CK4LOW	CK3LOW	CK1LOW	TGSHLD4	TGSHLD3	TGSHLD2	TGSHLD1	TGSHLD0
R/W	R/W	R/W	R/W	R/W	R/W	R/W	R/W

- 7 **CK4LOW** To set CCD clock4 are low under CCD TG.
- 6 **CK3LOW** To set CCD clock3 are low under CCD TG.
- 5 **CK1LOW** To set CCD clock1,2 are low under CCD TG.
- 4-0 **TGSHLD[4:0]** To set CCD TG shoulder width.  
 Note: You have to program the TGSHLD >= 2 (more than two).

**Offset 1Eh ..... Default value = 8'h20**

WDTIME3	WDTIME2	WDTIME1	WDTIME0	LINESEL3	LINESEL2	LINESEL1	LINESEL0
R/W	R/W	R/W	R/W	R/W	R/W	R/W	R/W

- 7-4 **WDTIME[3:0]** To set watch-dog time.  
 The unit is 30 seconds.
- 3-0 **LINESEL[3:0]** To set CIS Vertical DPI or dummy lines.  
 CIS : LINESEL = 0 full dpi.  
               = 1 1/2 dpi.  
               = 2 1/3 dpi.  
               .....  
               = 15 1/16 dpi.  
 CCD : LINESEL = 0 no dummy line.  
                   = 1 1 dummy line.  
                   = 2 2 dummy lines.  
                   .....  
                   = 15 15 dummy lines.  
 Note: CIS can be implemented dummy line by motor move method,not dummy lines.

**Offset 1Fh ..... Default value = 8'h00**

SCANFED7	SCANFED6	SCANFED5	SCANFED4	SCANFED3	SCANFED2	SCANFED1	SCANFED0
R/W	R/W	R/W	R/W	R/W	R/W	R/W	R/W

- 7-0 **SCANFED[7:0]** Move to scanning position by table one under two table operation.  
 Note: Can't be programmed to logic zero.

**Offset 20h ..... Default value = 8'h00**

BUFSEL7	BUFSEL6	BUFSEL5	BUFSEL4	BUFSEL3	BUFSEL2	BUFSEL1	BUFSEL0
R/W	R/W	R/W	R/W	R/W	R/W	R/W	R/W

- 7-0 **BUFSEL[7:0]** To set buffer condition (unit = 4k word).  
 Scanner execute backward/forward moving whenever buffer full.  
 If MAXWD < buffer condition, then motor move forward to scan.



**Offset 21h ..... Default value = 8'h00**

STEPNO7	STEPNO6	STEPNO5	STEPNO4	STEPNO3	STEPNO2	STEPNO1	STEPNO0
R/W	R/W	R/W	R/W	R/W	R/W	R/W	R/W

**7-0 STEPNO[7:0]** To set scanning forward slope curve of the acceleration/deceleration (table one slope).  
 Note: Can't be programmed to logic zero.

**Offset 22h ..... Default value = 8'h00**

FWDSTEP7	FWDSTEP6	FWDSTEP5	FWDSTEP4	FWDSTEP3	FWDSTEP2	FWDSTEP1	FWDSTEP0
R/W	R/W	R/W	R/W	R/W	R/W	R/W	R/W

**7-0 FWDSTEP[7:0]** To set steps number of the forward steps.  
 Note: Can't be programmed to logic zero.

**Offset 23h ..... Default value = 8'h00**

BWDSTEP7	BWDSTEP6	BWDSTEP5	BWDSTEP4	BWDSTEP3	BWDSTEP2	BWDSTEP1	BWDSTEP0
R/W	R/W	R/W	R/W	R/W	R/W	R/W	R/W

**7-0 BWDSTEP[7:0]** To set steps number of the backward steps.  
 Note: Can't be programmed to logic zero.

**Offset 24h ..... Default value = 8'h00**

FASTNO7	FASTNO6	FASTNO5	FASTNO4	FASTNO3	FASTNO2	FASTNO1	FASTNO0
R/W	R/W	R/W	R/W	R/W	R/W	R/W	R/W

**7-0 FASTNO[7:0]** To set scanning backward slope curve of the acceleration/deceleration (table two slope).  
 Note: Can't be programmed to logic zero.

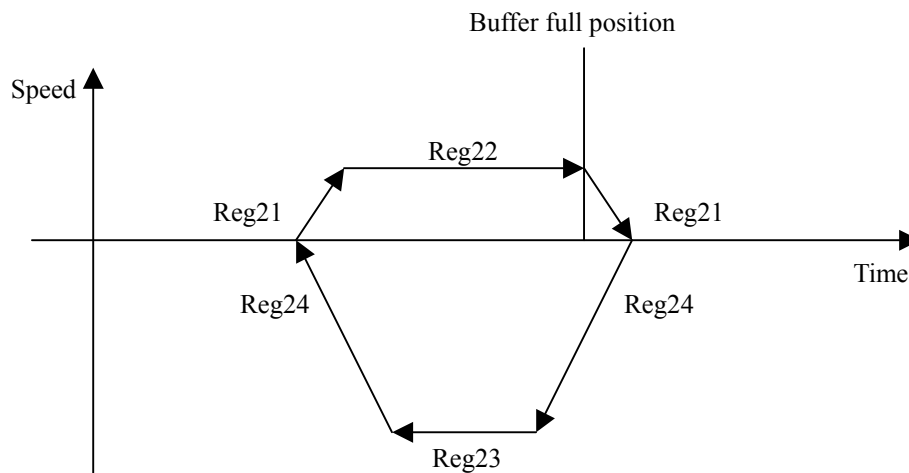



**Offset 25h ..... Default value = 8'h00**

X	X	X	X	LINCNT19	LINCNT18	LINCNT17	LINCNT16
X	X	X	X	R/W	R/W	R/W	R/W

7-4 RESERVED -

3-0 LINCNT[19:16] To set the scan lines number.  
 Note: Can't be programmed to logic zero.

**Offset 26h ..... Default value = 8'h00**

LINCNT15	LINCNT14	LINCNT13	LINCNT12	LINCNT11	LINCNT10	LINCNT9	LINCNT8
R/W	R/W	R/W	R/W	R/W	R/W	R/W	R/W

7-0 LINCNT[15:8] To set the scan lines number.  
 Note: Can't be programmed to logic zero.

**Offset 27h ..... Default value = 8'h00**

LINCNT7	LINCNT6	LINCNT5	LINCNT4	LINCNT3	LINCNT2	LINCNT1	LINCNT0
R/W	R/W	R/W	R/W	R/W	R/W	R/W	R/W

7-0 LINCNT[7:0] To set the scan lines number.  
 Note: Can't be programmed to logic zero.

**Offset 28h ..... Default value = 8'h00**

GMMWRDATA							
R/W							

GMMWRDATA This port write gamma table.

**Offset 29h ..... Default value = 8'hFF**

LAMPPWM7	LAMPPWM6	LAMPPWM5	LAMPPWM4	LAMPPWM3	LAMPPWM2	LAMPPWM1	LAMPPWM0
R/W	R/W	R/W	R/W	R/W	R/W	R/W	R/W

7-0 LAMPPWM[7:0] To set PWM duty for lamp power control.  
 0: 1/256 duty.  
 1: 2/256 duty.  
 ....  
 255:256/256 duty.

**Offset 2Ah ..... Default value = 8'h00**

RAMADDR15	RAMADDR14	RAMADDR13	RAMADDR12	RAMADDR11	RAMADDR10	RAMADDR9	RAMADDR8
R/W	R/W	R/W	R/W	R/W	R/W	R/W	R/W

7-0 RAMADDR[15:8] To set DRAM start address to access data.  
 Note: IRAM\_A[19:0]={RAMADDR[15:0],4'b0000}.



**Offset 2Bh ..... Default value = 8'h00**

RAMADDR7	RAMADDR6	RAMADDR5	RAMADDR4	RAMADDR3	RAMADDR2	RAMADDR1	RAMADDR0
R/W	R/W	R/W	R/W	R/W	R/W	R/W	R/W

**7-0 RAMADDR[7:0]** To set DRAM start address to access data.  
 Note: IRAM\_A[19:0]={RAMADDR[15:0],4'b0000}.

**Offset 2Ch ..... Default value = 8'h00**

X	X	X	X	DPISET11	DPISET10	DPISET9	DPISET8
X	X	X	X	R/W	R/W	R/W	R/W

**7-4 RESERVED** -

**3-0 DPISET[11:8]** Set resolution of DPI for average type or deletion type.  
 A. average type : digital average function support 1/2,1/3,1/4,1/5,1/6,1/8,1/10,1/12,1/15.  
     a. 2400 dpi scanner : can set 1200,800,600,480,400,300,240,200,160 dpi.  
     b. 1200 dpi scanner : can set 600,400,300,240,200,150,120,100,80 dpi.  
     c. 600 dpi scanner : can set 300,200,150,120,100,75,60,50 and 40 dpi.  
 B. deletion type : 2400,1200 or 600dpi to 1 dpi setting decrement by one dpi.  
 Note: Can't be programmed to logic zero.

**Offset 2Dh ..... Default value = 8'h00**

DPISET7	DPISET6	DPISET5	DPISET4	DPISET3	DPISET2	DPISET1	DPISET0
R/W	R/W	R/W	R/W	R/W	R/W	R/W	R/W

**7-0 DPISET[7:0]** Set resolution of DPI for average type or deletion type.  
 A. average type : digital average function support 1/2,1/3,1/4,1/5,1/6,1/8,1/10,1/12,1/15.  
     a. 2400 dpi scanner : can set 1200,800,600,480,400,300,240,200,160 dpi.  
     b. 1200 dpi scanner : can set 600,400,300,240,200,150,120,100,80 dpi.  
     c. 600 dpi scanner : can set 300,200,150,120,100,75,60,50 and 40 dpi.  
 B. deletion type : 2400,1200 or 600dpi to 1 dpi setting decrement by one dpi.  
 Note: Can't be programmed to logic zero.

**Offset 2Eh ..... Default value = 8'h00**

BWHI7	BWHI6	BWHI5	BWHI4	BWHI3	BWHI2	BWHI1	BWHI0
R/W	R/W	R/W	R/W	R/W	R/W	R/W	R/W

**7-0 BWHI[7:0]** To set Black & White threshold high level.

**Offset 2Fh ..... Default value = 8'h00**

BWLOW7	BWLOW6	BWLOW5	BWLOW4	BWLOW3	BWLOW2	BWLOW1	BWLOW0
R/W	R/W	R/W	R/W	R/W	R/W	R/W	R/W

**7-0 BWLOW[7:0]** To set Black & White threshold low level.

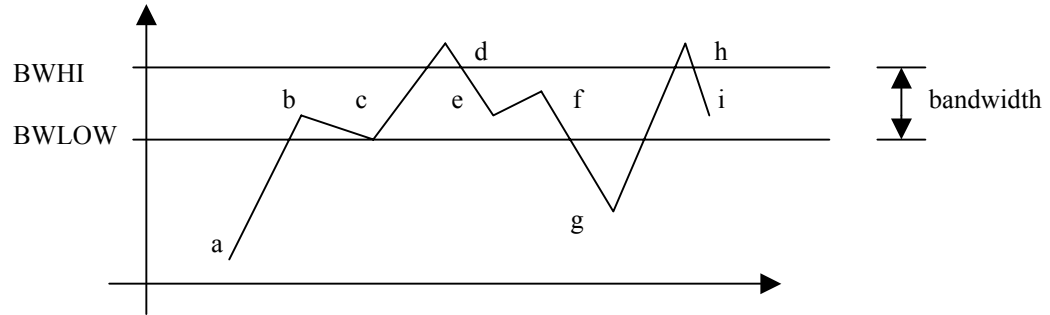

a,b,c,g : are black pixels  
d,e,f,h,i : are white pixels

**Offset 30h ..... Default value = 8'h00**

STRPIXEL15	STRPIXEL14	STRPIXEL13	STRPIXEL12	STRPIXEL11	STRPIXEL10	STRPIXEL9	STRPIXEL8
R/W	R/W	R/W	R/W	R/W	R/W	R/W	R/W

**7-0 STRPIXEL[15:8]** To set the begin pixel position (unit : pixel count).  
 $STRPIXEL = (TGW + 2 * TGSULD) + \text{Begin pixels number.}$   
 Note: Can't be programmed to logic zero.

**Offset 31h ..... Default value = 8'h00**

STRPIXEL7	STRPIXEL6	STRPIXEL5	STRPIXEL4	STRPIXEL3	STRPIXEL2	STRPIXEL1	STRPIXEL0
R/W	R/W	R/W	R/W	R/W	R/W	R/W	R/W

**7-0 STRPIXEL[7:0]** To set the begin pixel position (unit : pixel count).  
 $STRPIXEL = (TGW + 2 * TGSULD) + \text{Begin pixels number.}$   
 Note: Can't be programmed to logic zero.

**Offset 32h ..... Default value = 8'h00**

ENDPIXEL15	ENDPIXEL14	ENDPIXEL13	ENDPIXEL12	ENDPIXEL11	ENDPIXEL10	ENDPIXEL9	ENDPIXEL8
R/W	R/W	R/W	R/W	R/W	R/W	R/W	R/W

**7-0 ENDPIXEL[15:8]** To set the end pixel position (unit : pixel count).  
 $ENDPIXEL = (TGW + 2 * TGSULD) + \text{End pixels number.}$   
 Note: Can't be programmed to logic zero.







**Offset 37h ..... Default value = 8'h00**

MAXWD7	MAXWD6	MAXWD5	MAXWD4	MAXWD3	MAXWD2	MAXWD1	MAXWD0
R/W	R/W	R/W	R/W	R/W	R/W	R/W	R/W

**7-0 MAXWD[7:0]** To set maximum word size per line for ASIC estimation.  
 If usable buffer size < MAXWD, then buffer is full. The scanner execute forward  
 And Backward moving.

**Offset 38h ..... Default value = 8'h15**

LPERIOD15	LPERIOD14	LPERIOD13	LPERIOD12	LPERIOD11	LPERIOD10	LPERIOD9	LPERIOD8
R/W	R/W	R/W	R/W	R/W	R/W	R/W	R/W

**7-0 LPERIOD[15:8]** To set Line period(or exposure time) for CCD.  
 Unit : pixel count  
 Note: Can't be programmed to logic zero.

**Offset 39h ..... Default value = 8'h18**

LPERIOD7	LPERIOD6	LPERIOD5	LPERIOD4	LPERIOD3	LPERIOD2	LPERIOD1	LPERIOD0
R/W	R/W	R/W	R/W	R/W	R/W	R/W	R/W

**7-0 LPERIOD[7:0]** To set Line period(or exposure time) for CCD.  
 Unit : pixel count  
 Note: Can't be programmed to logic zero.

**Offset 3Ah ..... Default value = 8'h00**

X	X	X	X	X	X	X	FEWRDATA8
X	X	X	X	X	X	X	R/W

**7-1 RESERVED** -  
**0 FEWRDATA8** This port is used to write data to control register of front-end.

**Offset 3Bh ..... Default value = 8'h00**

FEWRDATA7	FEWRDATA6	FEWRDATA5	FEWRDATA4	FEWRDATA3	FEWRDATA2	FEWRDATA1	FEWRDATA0
R/W	R/W	R/W	R/W	R/W	R/W	R/W	R/W

**7-0 FEWRDATA[7:0]** This port is used to write data to control register of front-end.

**Offset 3Ch ..... Default value = 8'h00**

RAMWRDATA
R/W

**RAMWRDATA** This port is used to write data to DRAM.



**Offset 3Dh ..... Default value = 8'h00**

X	X	X	X	FEEDL19	FEEDL18	FEEDL17	FEEDL16
X	X	X	X	R/W	R/W	R/W	R/W

7-4 RESERVED -

3-0 FEEDL[19:16] To set feeding steps number of motor move.  
 Note: Can't be programmed to logic zero.

**Offset 3Eh ..... Default value = 8'h00**

FEEDL15	FEEDL14	FEEDL13	FEEDL12	FEEDL11	FEEDL10	FEEDL9	FEEDL8
R/W	R/W	R/W	R/W	R/W	R/W	R/W	R/W

7-0 FEEDL[15:8] To set feeding steps number of motor move.  
 Note: Can't be programmed to logic zero.

**Offset 3Fh ..... Default value = 8'h00**

FEEDL7	FEEDL6	FEEDL5	FEEDL4	FEEDL3	FEEDL2	FEEDL1	FEEDL0
R/W	R/W	R/W	R/W	R/W	R/W	R/W	R/W

7-0 FEEDL[7:0] To set feeding steps number of motor move.  
 Note: Can't be programmed to logic zero.

**Offset 40h**

X	X	X	X	X	HISPDFLG	MOTMFLG	DATAENB
X	X	X	X	X	R	R	R

7-3 RESERVED -

- 2 HISPDFLG 1 Motor is high-speed moving.
- 1 MOTMFLG 0 Motor is stop.  
1 Motor is moving.
- 0 DATAENB 0 Scanner is command mode.  
1 Scanner is scanning mode.



**Offset 41h**

PWRBIT	BUFEMPTY	FEEDFSH	SCANFSH	HOMESNR	LAMPSTS	FEBUSY	MOTORENB
R	R	R	R	R	R	R	R

- 7 PWRBIT** To indicate power status.  
Power on initial,PWRBIT=0;
- 6 BUFEMPTY** 0 To indicate that the image buffer is not empty.  
1 To indicate that the image buffer is empty.
- 5 FEEDFSH** 0 To indicate that motor feeding is not finished.  
1 To indicate that motor feeding is finished.
- 4 SCANFSH** 0 To indicate that scan is not finished.  
1 To indicate that scan is finished.
- 3 HOMESNR** 0 Home sensor is on (is not home position).  
1 Home sensor is off (is home position).
- 2 LAMPSTS** 0 Lamp is off.  
1 Lamp is on.
- 1 FEBUSY** 0 Front end is ready and be able to read/write again.  
1 Front end is busy and can not read/write again.
- 0 MOTORENB** 0 Motor is not processing.  
1 Motor is processing.

**Offset 42h**

X	X	X	X	VALIDWORD 19	VALIDWORD 18	VALIDWORD 17	VALIDWORD 16
X	X	X	X	R	R	R	R

- 7-4 RESERVED** -
- 3-0 VALIDWORD [19:16]** To indicate available words to read out in the image buffer of DRAM.

**Offset 43h**

VALIDWORD 15	VALIDWORD 14	VALIDWORD 13	VALIDWORD 12	VALIDWORD 11	VALIDWORD 10	VALIDWORD 9	VALIDWORD 8
R	R	R	R	R	R	R	R

- 7-0 VALIDWORD [15:9]** To indicate available words to read out in the image buffer of DRAM.

**Offset 44h**

VALIDWORD 7	VALIDWORD 6	VALIDWORD 5	VALIDWORD 4	VALIDWORD 3	VALIDWORD 2	VALIDWORD 1	VALIDWORD 0
R	R	R	R	R	R	R	R

- 7-0 VALIDWORD [7:0]** To indicate available words to read out in the image buffer of DRAM.



**Offset 45h**

RAMRDDATA
R

**RAMRDDATA** This port for read DRAM data.

**Offset 46h**

X	X	X	X	X	X	X	FERDDATA8
X	X	X	X	X	X	X	R

**7-1 RESERVED** -

**0 FERDDATA8** This port is used to read out data from front-end control register.

**Offset 47h**

FERDDATA7	FERDDATA6	FERDDATA5	FERDDATA4	FERDDATA3	FERDDATA2	FERDDATA1	FERDDATA0
R	R	R	R	R	R	R	R

**7-0 FERDDATA[7:0]** This port is used to read out data from front-end control register.

**Offset 48h**

X	X	X	X	FEDCNT19	FEDCNT18	FEDCNT17	FEDCNT16
X	X	X	X	R	R	R	R

**7-4 RESERVED** -

**3-0 FEDCNT[19:16]** To read motor feeding steps number.  
 For example,if you have set moving steps no. and execute moving command.  
 You can read out steps no. moved.

**Offset 49h**

FEDCNT15	FEDCNT14	FEDCNT13	FEDCNT12	FEDCNT11	FEDCNT10	FEDCNT9	FEDCNT8
R	R	R	R	R	R	R	R

**7-0 FEDCNT[15:8]** To read motor feeding steps number.  
 For example,if you have set moving steps no. and execute moving command.  
 You can read out steps no. moved.

**Offset 4Ah**

FEDCNT7	FEDCNT6	FEDCNT5	FEDCNT4	FEDCNT3	FEDCNT2	FEDCNT1	FEDCNT0
R	R	R	R	R	R	R	R

**7-0 FEDCNT[7:0]** To read motor feeding steps number.  
 For example,if you have set moving steps no. and execute moving command.  
 You can read out steps no. moved.



**Offset 4Bh**

X	X	X	X	SCANCNT19	SCANCNT18	SCANCNT17	SCANCNT16
X	X	X	X	R	R	R	R

7-4 RESERVED -

3-0 SCANCNT[19:16] To read scanner finished lines number.

**Offset 4Ch**

SCANCNT15	SCANCNT14	SCANCNT13	SCANCNT12	SCANCNT11	SCANCNT10	SCANCNT9	SCANCNT8
R	R	R	R	R	R	R	R

7-0 SCANCNT[15:8] To read scanner finished lines number.

**Offset 4Dh**

SCANCNT7	SCANCNT6	SCANCNT5	SCANCNT4	SCANCNT3	SCANCNT2	SCANCNT1	SCANCNT0
R	R	R	R	R	R	R	R

7-0 SCANCNT[7:0] To read scanner finished lines number.

**Offset 4Eh**

GMMRDDATA							
R							

GMMRDDATA This port to read back the gamma table.

**Offset 50h ..... Default value = 8'h00**

X	X	FERDA5	FERDA4	FERDA3	FERDA2	FERDA1	FERDA0
X	X	R/W	R/W	R/W	R/W	R/W	R/W

7-6 RESERVED -

5-0 FERDA[5:0] This port is read address setting for Front End control register read.

**Offset 51h ..... Default value = 8'h00**

X	X	FEWRA5	FEWRA4	FEWRA3	FEWRA2	FEWRA1	FEWRA0
X	X	R/W	R/W	R/W	R/W	R/W	R/W

7-6 RESERVED -

5-0 FEWRA[5:0] This port is write address setting for Front End control register write.



**Offset 52h ..... Default value = 8'h00**

X	X	X	RHI4	RHI3	RHI2	RHI1	RHI0
X	X	X	R/W	R/W	R/W	R/W	R/W

7-5 RESERVED -

4-0 RHI[4:0] To latch R channel high byte data of AFE.

**Offset 53h ..... Default value = 8'h00**

X	X	X	RLOW4	RLOW3	RLOW2	RLOW1	RLOW0
X	X	X	R/W	R/W	R/W	R/W	R/W

7-5 RESERVED -

4-0 RLOW[4:0] To latch R channel low byte data of AFE.

**Offset 54h ..... Default value = 8'h00**

X	X	X	GHI4	GHI3	GHI2	GHI1	GHI0
X	X	X	R/W	R/W	R/W	R/W	R/W

7-5 RESERVED -

4-0 GHI[4:0] To latch G channel high byte data of AFE.

**Offset 55h ..... Default value = 8'h00**

X	X	X	GLOW4	GLOW3	GLOW2	GLOW1	GLOW0
X	X	X	R/W	R/W	R/W	R/W	R/W

7-5 RESERVED -

4-0 GLOW[4:0] To latch G channel low byte data of AFE.

**Offset 56h ..... Default value = 8'h00**

X	X	X	BHI4	BHI3	BHI2	BHI1	BHI0
X	X	X	R/W	R/W	R/W	R/W	R/W

7-5 RESERVED -

4-0 BHI[4:0] To latch B channel high byte data of AFE.

**Offset 57h ..... Default value = 8'h00**

X	X	X	BLOW4	BLOW3	BLOW2	BLOW1	BLOW0
X	X	X	R/W	R/W	R/W	R/W	R/W

7-5 RESERVED -

4-0 BLOW[4:0] To latch B channel low byte data of AFE.

(1). Color, fine gray or fine line-art : 12 phase/pixel

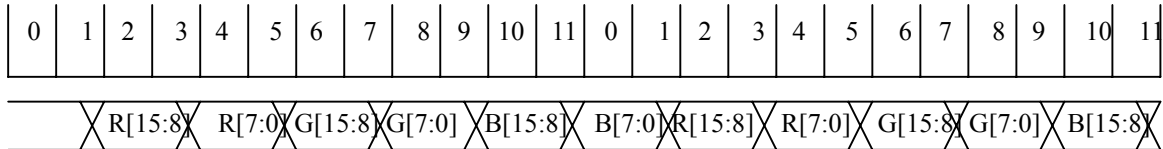

RHI = 01H    RLOW = 03H  
 GHI = 05H    GLOW = 07H  
 BHI = 09H    BLOW = 11H

(2). Fast gray or fast line-art : 6 phase/pixel

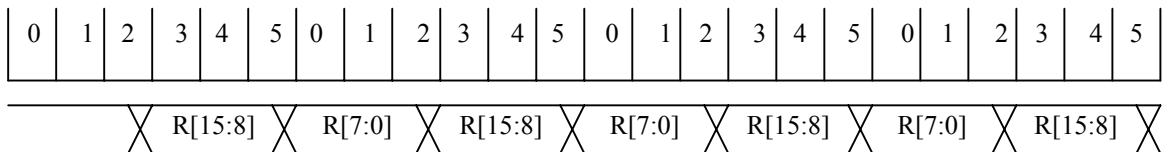

RHI = 02H RLOW = 05H

**Offset 58h ..... Default value = 8'h00**

VSMP4	VSMP3	VSMP2	VSMP1	VSMP0	VSMPW2	VSMPW1	VSMPW0
R/W	R/W	R/W	R/W	R/W	R/W	R/W	R/W

7-3 VSMP[4:0] To set the rising edge position of image sampling for AFE.

2-0 VSMPW[2:0] To set the pulse width of image sampling.

(1). Color, fine gray or fine line-art : 12 phase/pixel

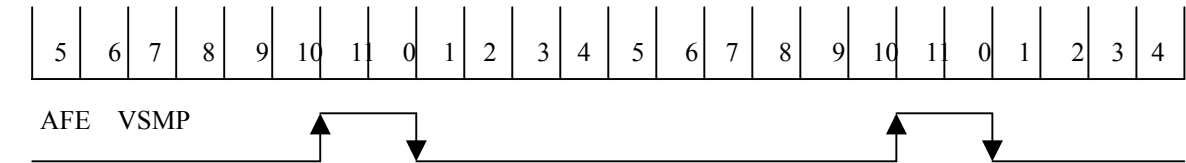

Reg58=52H : VSMP[4:0]=10H    VSMPW[2:0]=2H

(2). Fast gray or fast line-art : 6 phase/pixel

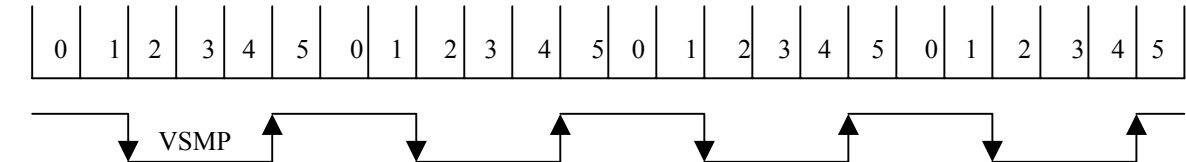

Reg58=0BH : VSMP[4:0]=01H    VSMPW=3H

**Offset 59h ..... Default value = 8'h00**

BSMP4	BSMP3	BSMP2	BSMP1	BSMP0	BSMPW2	BSMPW1	BSMPW0
R/W	R/W	R/W	R/W	R/W	R/W	R/W	R/W

**7-3 BSMP[4:0]** To set the rising edge position of dark voltage sampling for AFE.

**2-0 BSMPW[2:0]** To set the pulse width of dark voltage sampling.

(1). Color, fine gray or fine line-art: 12 phase/pixel

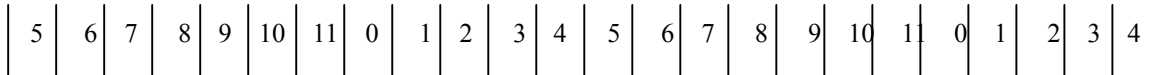

AFE BSMP

Reg59=52H : BSMP[4:0]=10H BSMPW[2:0]=2H

(2). Fast gray or fast line-art : 6 phase/pixel

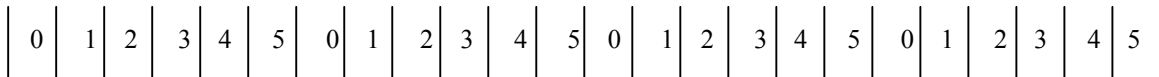

BSMP

Reg59=0BH : BSMP[4:0]=01H BSMPW=3H

**Offset 5Ah ..... Default value = 8'hC0**

ADCLKINV	RLCSEL	CDSREF1	CDSREF0	RLC3	RLC2	RLC1	RLC0
R/W	R/W	R/W	R/W	R/W	R/W	R/W	R/W

**7 ADCLKINV** 0 ADC clock reverse.  
1 To reverse CCD Clock4.

**6 RLCSEL** 0 Don't select.  
1 Select reset level clamp on a pixel-by-pixel basis.

**5-4 CDSREF[1:0]** To set the front-end CDSREF for line rate scanning type.

**3-0 RLC[3:0]** To set the front-end RLC for line rate scanning type.

**Offset 5Bh ..... Default value = 8'h00**

X	X	X	X	X	X	GMMADDR9	GMMADDR8
X	X	X	X	X	X	R/W	R/W

**7-2 RESERVED** -

**1-0 GMMADDR[9:8]** To set the front-end RLC for line rate scanning type.

**Offset 5Ch ..... Default value = 8'h00**

GMMADDR7	GMMADDR6	GMMADDR5	GMMADDR4	GMMADDR3	GMMADDR2	GMMADDR1	GMMADDR0
R/W	R/W	R/W	R/W	R/W	R/W	R/W	R/W

**7-0 GMMADDR[7:0]** To set the front-end RLC for line rate scanning type.





**Offset 5Dh ..... Default value = 8'h00**

HISPD7	HISPD6	HISPD5	HISPD4	HISPD3	HISPD2	HISPD1	HISPD0
R/W	R/W	R/W	R/W	R/W	R/W	R/W	R/W

**7-0 HISPD[7:0]** To set change of the moving speed during moving.  
 Note: Can't be programmed to logic zero.

**Offset 5Eh ..... Default value = 8'h00**

DECSEL2	DECSEL1	DECSEL0	STOPTIM4	STOPTIM3	STOPTIM2	STOPTIM1	STOPTIM0
R/W	R/W	R/W	R/W	R/W	R/W	R/W	R/W

**7-5 DECSEL[2:0]** Select deceleration steps whenever go home.  
 000 1 steps deceleration  
 001 2 steps deceleration  
 010 4 steps deceleration  
 011 8 steps deceleration  
 100 16 steps deceleration  
 101 32 steps deceleration  
 110 64 steps deceleration  
 111 128 steps deceleration

**4-0 STOPTIM[4:0]** Select acceleration/deceleration stop time.  
 Note: STOPTIM simulation for ASIC must be set to tgtime=6,7.  
 Can't be programmed to logic zero.

**Offset 5Fh ..... Default value = 8'h00**

FMOVDEC7	FMOVDEC6	FMOVDEC5	FMOVDEC4	FMOVDEC3	FMOVDEC2	FMOVDEC1	FMOVDEC0
R/W	R/W	R/W	R/W	R/W	R/W	R/W	R/W

**7-0 FMOVDEC[7:0]** To set go-home fast move deceleration slope steps (table five slope).  
 Note: Can't be programmed to logic zero.

**Offset 60h ..... Default value = 8'h00**

X	X	X	Z1MOD20	Z1MOD19	Z1MOD18	Z1MOD17	Z1MOD16
X	X	X	R/W	R/W	R/W	R/W	R/W

**7-5 RESERVED** -

**4-0 Z1MOD[20:16]** To set the slope curve of acceleration/deceleration table mode value.  
 Under buffer full moving.  
 Note: It should be more than LPERIOD.

**Offset 61h ..... Default value = 8'h00**

Z1MOD15	Z1MOD14	Z1MOD13	Z1MOD12	Z1MOD11	Z1MOD10	Z1MOD7	Z1MOD8
R/W	R/W	R/W	R/W	R/W	R/W	R/W	R/W

**7-0 Z1MOD[15:8]** To set the slope curve of acceleration/deceleration table mode value.  
 Under buffer full moving.  
 Note: It should be more than LPERIOD.



**Offset 62h ..... Default value = 8'h00**

Z1MOD7	Z1MOD6	Z1MOD5	Z1MOD4	Z1MOD3	Z1MOD2	Z1MOD1	Z1MOD0
R/W	R/W	R/W	R/W	R/W	R/W	R/W	R/W

**7-0 Z1MOD[7:0]** To set the slope curve of acceleration/deceleration table mode value.  
Under buffer full moving.  
Note: It should be more than LPERIOD.

**Offset 63h ..... Default value = 8'h00**

X	X	X	Z2MOD20	Z2MOD19	Z2MOD18	Z2MOD17	Z2MOD16
X	X	X	R/W	R/W	R/W	R/W	R/W

**7-5 RESERVED** -

**7-0 Z2MOD[20:16]** To set the slope curve of acceleration/deceleration mode value.  
Under first time moving to scanning.  
Note: It should be more than LPERIOD.

**Offset 64h ..... Default value = 8'h00**

Z2MOD15	Z2MOD14	Z2MOD13	Z2MOD12	Z2MOD11	Z2MOD10	Z2MOD9	Z2MOD8
R/W	R/W	R/W	R/W	R/W	R/W	R/W	R/W

**7-0 Z2MOD[15:8]** To set the slope curve of acceleration/deceleration mode value.  
Under first time moving to scanning.  
Note: It should be more than LPERIOD.

**Offset 65h ..... Default value = 8'h00**

Z2MOD7	Z2MOD6	Z2MOD5	Z2MOD4	Z2MOD3	Z2MOD2	Z2MOD1	Z2MOD0
R/W	R/W	R/W	R/W	R/W	R/W	R/W	R/W

**7-0 Z2MOD[7:0]** To set the slope curve of acceleration/deceleration mode value.  
Under first time moving to scanning.  
Note: It should be more than LPERIOD.

(1). Two table moving :

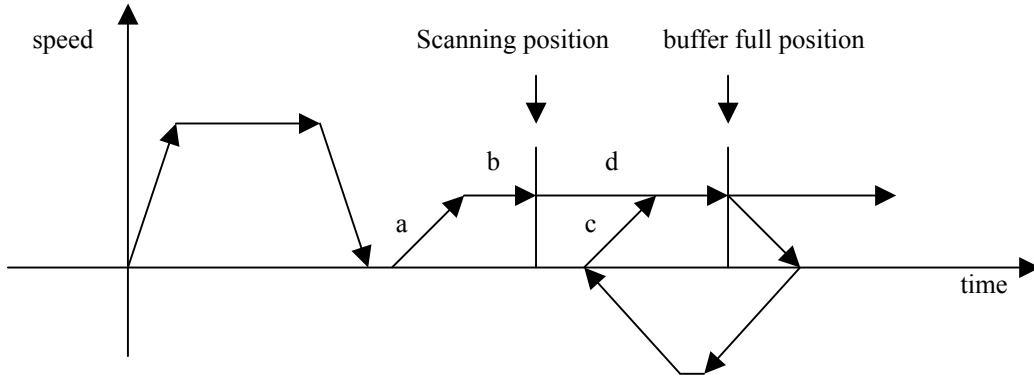

(1). One table moving :

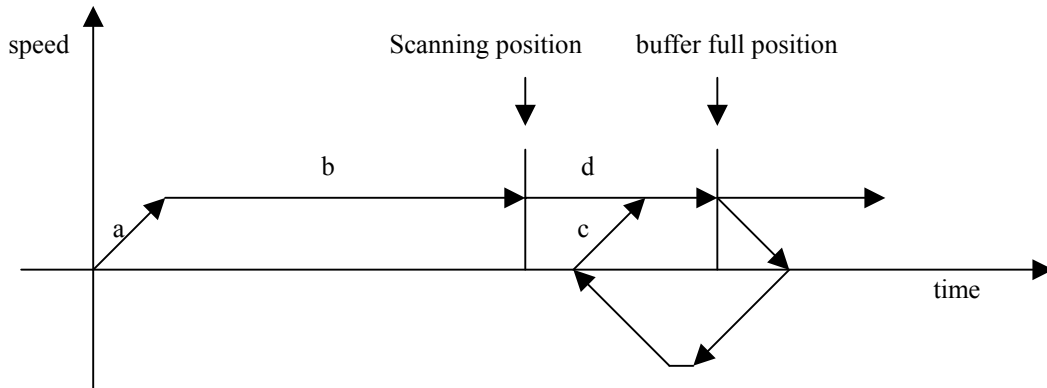

$$\{a+(b-1)\} \text{ mode LPERIOD} = Z2MOD$$

$$\{c+(d-1)\} \text{ mode LPERIOD} = Z1MOD$$

Note: If MCNTSET[1:0]=01 or 10 or 11, then (each step curve value + 1)/VCNT.

VCNT= system clocks per pixel / (MCNTSET+1).

**Offset 66h ..... Default value = 8'h00**

PHFREQ7	PHFREQ6	PHFREQ5	PHFREQ4	PHFREQ3	PHFREQ2	PHFREQ1	PHFREQ0
R/W	R/W	R/W	R/W	R/W	R/W	R/W	R/W

**7-0 PHFREQ[7:0]** To set PWM frequency for motor phase of uni-polar.  
Frequency: (24MHz)/[(PHFREQ+1)\*4]



**Offset 67h ..... Default value = 8'h7F**

STEPSEL1	STEPSEL0	MTRPWM5	MTRPWM4	MTRPWM3	MTRPWM2	MTRPWM1	MTRPWM0
R/W	R/W	R/W	R/W	R/W	R/W	R/W	R/W

**7-6 STEPSEL[1:0]** For table one or two scanning move step type selection.

- (1) Bi-polar:
  - 00 Full step (for 1939,1940,2916,6219 or 3966).
  - 01 Half step (for 1939,1940,2916,6219 or 3966).
  - 10 Quarter step (for 2916 or 6219).
  - 11 Reserved.
- (2) Uni-polar :
  - 00 Two-phase-on full step.
  - 01 Half step.
  - 10 Reserved.
  - 11 Single-phase-on full step.

**5-0 MTRPWM[5:0]** To set PWM duty cycle for table one motor phase of uni-polar.

- MTRPWM = 0 1/64 duty
- = 1 2/64 duty
- = 2 3/64 duty
- .....
- = 63 64/64 duty

Note: If PHFREQ < 0FH, then PWM setting must < (PHFREQ+1)\*4

**Offset 68h ..... Default value = 8'h7F**

FSTPSEL1	FSTPSEL0	FASTPWM5	FASTPWM4	FASTPWM3	FASTPWM2	FASTPWM1	FASTPWM0
R/W	R/W	R/W	R/W	R/W	R/W	R/W	R/W

**7-6 FSTPSEL[1:0]** For table two fast moving step type selection.

- (1) Bi-polar:
  - 00 Full step (for 1939,1940,2916,6219 or 3966).
  - 01 Half step (for 1939,1940,2916,6219 or 3966).
  - 10 Quarter step (for 2916 or 6219).
  - 11 Reserved.
- (2) Uni-polar :
  - 00 Two-phase-on full step.
  - 01 Half step.
  - 10 Reserved.
  - 11 Single-phase-on full step.

**5-0 FASTPWM[5:0]** To set PWM duty cycle for table one motor phase of uni-polar.

- FASTPWM = 0 1/64 duty
- = 1 2/64 duty
- = 2 3/64 duty
- .....
- = 63 64/64 duty

Note: If PHFREQ < 0FH, then PWM setting must < (PHFREQ+1)\*4

**Offset 69h ..... Default value = 8'h00**

FSHDEC7	FSHDEC6	FSHDEC5	FSHDEC4	FSHDEC3	FSHDEC2	FSHDEC1	FSHDEC0
R/W	R/W	R/W	R/W	R/W	R/W	R/W	R/W

**7-0 FSHDEC[7:0]** Set scan-finish deceleration slop steps(table three slope).  
 Note: Can't be programmed to logic zero.

**Offset 6Ah ..... Default value = 8'h00**

FMOVNO7	FMOVNO6	FMOVNO5	FMOVNO4	FMOVNO3	FMOVNO2	FMOVNO1	FMOVNO0
R/W	R/W	R/W	R/W	R/W	R/W	R/W	R/W

**7-0 FMOVNO[7:0]** Set fast moving slop steps(table four slope).  
 Note: Can't be programmed to logic zero.

(1). Two table moving :

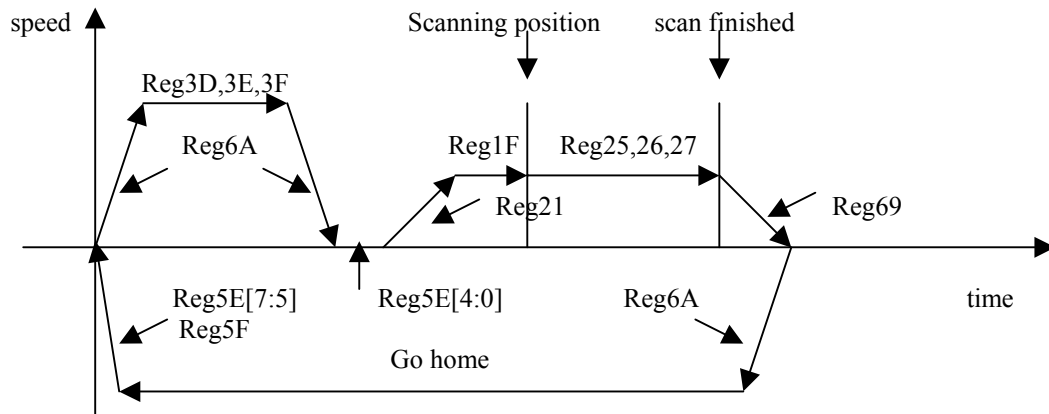

(1). One table moving :

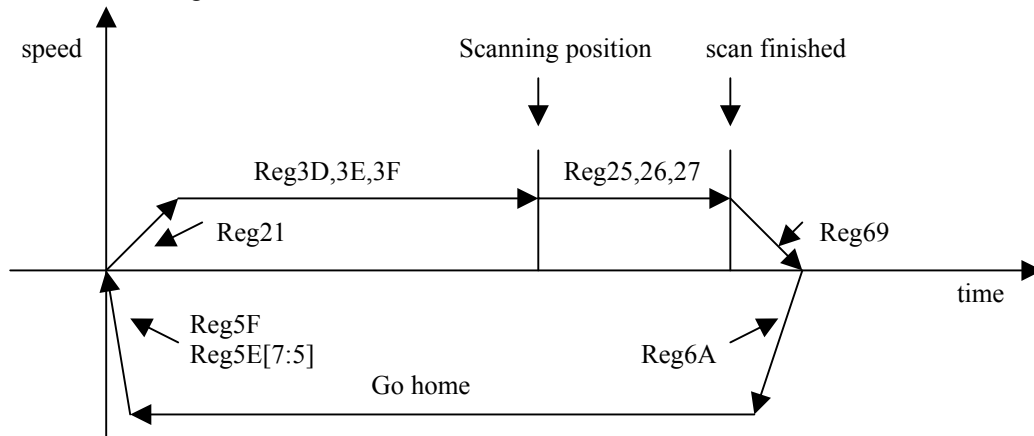



**Offset 6Bh ..... Default value = 8'h00**

MULTFILM	GPOM13	GPOM12	GPOM11	X	X	GPO18	GPO17
R/W	R/W	R/W	R/W	X	X	R/W	R/W

- 7 **MULTFILM** To control motor phase idle to meet multi-film scan.
- 6 **GPIOM13** 0 Output GPO13.  
1 Output MOTORTGO.
- 5-4 **GPOM[12:11]** To select GPIO12~11 as Bi-polar motor driver V-ref input voltage in order to control drive current.  
Note: GPIO12: 1. Pull up by resister to indicate that ASIC turn on lamp power whenever power on initial.  
2. Pull down by resister to indicate that ASIC turn off lamp power whenever power on initial.  
3. This pin can control bi-polar motor driver 1939,1940,2916, 6219 or 3955 Vref in order to Control Imax. current.  
GPIO11: This pin can control bi-polar motor driver 1939,1940,2916,6219 or 3955 Vref in order to Control Imax. current.
- 3-2 **RESERVED** -
- 3-0 **GPIO[18:17]** Output GPO18,GPO17 ports.

**Offset 6Ch ..... Default value = 8'h00**

GPIO16	GPIO15	GPIO14	GPIO13	GPIO12	GPIO11	GPIO10	GPIO9
R/W	R/W	R/W	R/W	R/W	R/W	R/W	R/W

- 7-0 **GPIO[16:9]** GPIO16~9 outputs ports

**Offset 6Dh ..... Default value = 8'h00**

GPIO8	GPIO7	GPIO6	GPIO5	GPIO4	GPIO3	GPIO2	GPIO1
R/W	R/W	R/W	R/W	R/W	R/W	R/W	R/W

- 7-0 **GPIO[8:1]** GPIO8~1 outputs ports

**Offset 6Eh ..... Default value = 8'h00**

GPOE16	GPOE15	GPOE14	GPOE13	GPOE12	GPOE11	GPOE10	GPOE9
R/W	R/W	R/W	R/W	R/W	R/W	R/W	R/W

- 7-0 **GPOE[16:9]** GPOE16~9 ports output enable set.  
0 Input.  
1 Output.

**Offset 6Fh ..... Default value = 8'h00**

GPOE8	GPOE7	GPOE6	GPOE5	GPOE4	GPOE3	GPOE2	GPOE1
R/W	R/W	R/W	R/W	R/W	R/W	R/W	R/W

- 7-0 **GPOE[8:1]** GPOE8~1 ports output enable set.  
0 Input.  
1 Output.

**Offset 70h ..... Default value = 8'h15**

X	X	X	RSH4	RSH3	RSH2	RSH1	RSH0
X	X	X	R/W	R/W	R/W	R/W	R/W

7-5 RESERVED -  
 4-0 RSH[4:0] Set CCD RS rising edge position.

**Offset 71h ..... Default value = 8'h17**

X	X	X	RSL4	RSL3	RSL2	RSL1	RSL0
X	X	X	R/W	R/W	R/W	R/W	R/W

7-5 RESERVED -  
 4-0 RSL[4:0] Set CCD RS falling edge position.

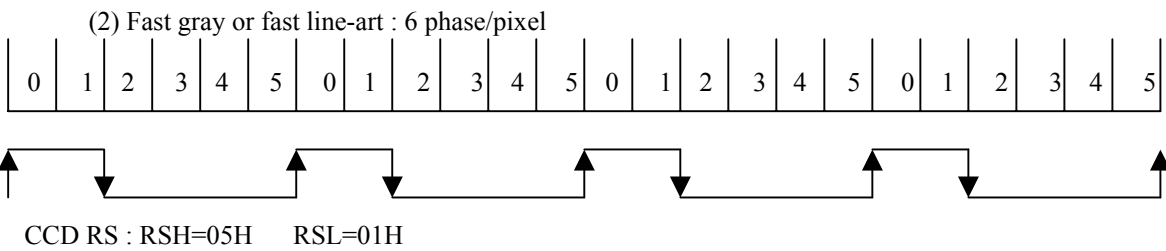
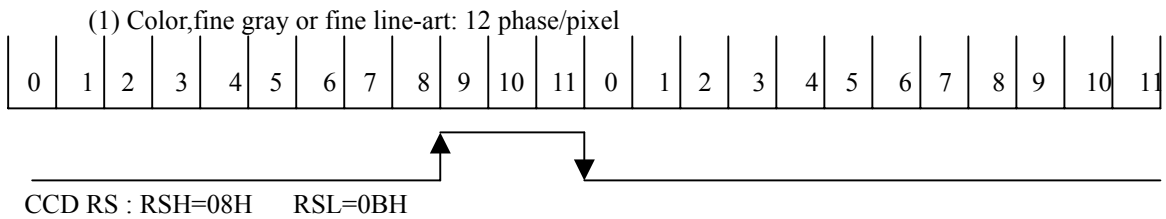

**Offset 72h ..... Default value = 8'h15**

X	X	X	CPH4	CPH3	CPH2	CPH1	CPH0
X	X	X	R/W	R/W	R/W	R/W	R/W

7-5 RESERVED -  
 4-0 CPH[4:0] Set CCD CP rising edge position.

**Offset 73h ..... Default value = 8'h17**

X	X	X	CPL4	CPL3	CPL2	CPL1	CPL0
X	X	X	R/W	R/W	R/W	R/W	R/W

7-5 RESERVED -  
 4-0 CPL[4:0] Set CCD CP falling edge position.

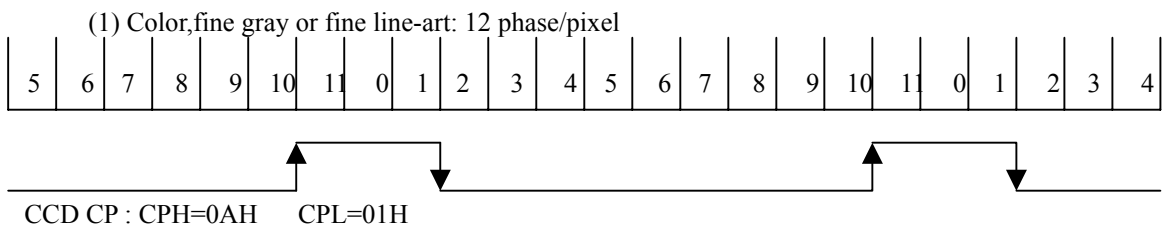

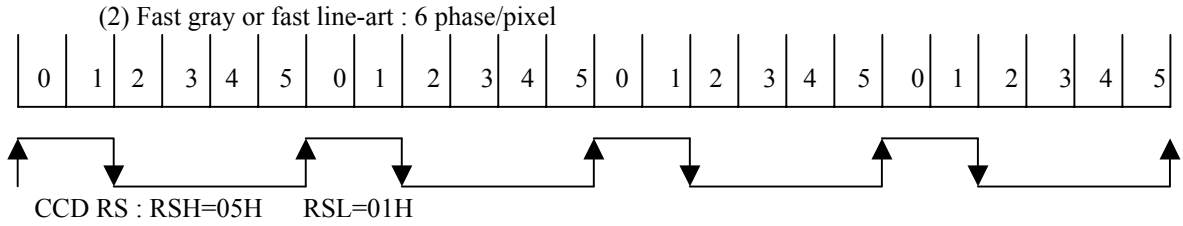

**Offset 74h ..... Default value = 8'h00**

X	X	X	X	X	X	CK1MAP17	CK1MAP16
X	X	X	X	X	X	R/W	R/W

7-2 RESERVED -

1-0 CK1MAP[17:16] CCD clock 1 bits mapping function.

**Offset 75h ..... Default value = 8'h00**

CK1MAP15	CK1MAP14	CK1MAP13	CK1MAP12	CK1MAP11	CK1MAP10	CK1MAP9	CK1MAP8
R/W	R/W	R/W	R/W	R/W	R/W	R/W	R/W

7-0 CK1MAP[15:8] CCD clock 1 bits mapping function.

**Offset 76h ..... Default value = 8'h00**

CK1MAP7	CK1MAP6	CK1MAP5	CK1MAP4	CK1MAP3	CK1MAP2	CK1MAP1	CK1MAP0
R/W	R/W	R/W	R/W	R/W	R/W	R/W	R/W

7-0 CK1MAP[7:0] CCD clock 1 bits mapping function.

**Offset 77h ..... Default value = 8'h00**

X	X	X	X	X	X	CK3MAP17	CK3MAP16
X	X	X	X	X	X	R/W	R/W

7-2 RESERVED -

1-0 CK3MAP[17:16] CCD clock 3 bits mapping function.

**Offset 78h ..... Default value = 8'h00**

CK3MAP15	CK3MAP14	CK3MAP13	CK3MAP12	CK3MAP11	CK3MAP10	CK3MAP9	CK3MAP8
R/W	R/W	R/W	R/W	R/W	R/W	R/W	R/W

7-0 CK3MAP[15:8] CCD clock 3 bits mapping function.

**Offset 79h ..... Default value = 8'h00**

CK3MAP7	CK3MAP6	CK3MAP5	CK3MAP4	CK3MAP3	CK3MAP2	CK3MAP1	CK3MAP0
R/W	R/W	R/W	R/W	R/W	R/W	R/W	R/W

7-0 CK3MAP[7:0] CCD clock 3 bits mapping function.





**Offset 7Ah ..... Default value = 8'h00**

X	X	X	X	X	X	CK4MAP17	CK4MAP16
X	X	X	X	X	X	R/W	R/W

7-2 RESERVED -

1-0 CK4MAP[17:16] CCD clock 4 bits mapping function.

**Offset 7Bh ..... Default value = 8'h00**

CK4MAP15	CK4MAP14	CK4MAP13	CK4MAP12	CK4MAP11	CK4MAP10	CK4MAP9	CK4MAP8
R/W	R/W	R/W	R/W	R/W	R/W	R/W	R/W

7-0 CK4MAP[15:8] CCD clock 4 bits mapping function.

**Offset 7Ch ..... Default value = 8'h00**

CK4MAP7	CK4MAP6	CK4MAP5	CK4MAP4	CK4MAP3	CK4MAP2	CK4MAP1	CK4MAP0
R/W	R/W	R/W	R/W	R/W	R/W	R/W	R/W

7-0 CK4MAP[7:0] CCD clock 4 bits mapping function.

**Offset 7Dh ..... Default value = 8'h00**

CK1NEG	CK3NEG	CK4NEG	RSNEG	CPNEG	BSMPNEG	VSMPNEG	DLYSET
R/W	R/W	R/W	R/W	R/W	R/W	R/W	R/W

- 7 **CK1NEG** 0 CCD clock1,clock2 output locate at positive edge position of system clock.  
1 CCD clock1,clock2 output locate at negative edge position of system clock.
- 6 **CK3NEG** 0 CCD clock3 output locate at positive edge position of system clock.  
1 CCD clock3 output locate at negative edge position of system clock.
- 5 **CK4NEG** 0 CCD clock4 output locate at positive edge position of system clock.  
1 CCD clock4 output locate at negative edge position of system clock.
- 4 **RSNEG** 0 CCD RS output locate at positive edge position of system clock.  
1 CCD RS output locate at negative edge position of system clock.
- 3 **CPNEG** 0 CCD CP output locate at positive edge position of system clock.  
1 CCD CP output locate at negative edge position of system clock.
- 2 **BSMPNEG** 0 AFE video sample output locate at positive edge position of system clock.  
1 AFE video sample output locate at negative edge position of system clock.
- 1 **VSMPNEG** 0 AFE dark sample output locate at positive edge position of system clock.  
1 AFE dark sample output locate at negative edge position of system clock.
- 0 **DLYSET** 0 Disable this function.  
1 To enable VSMP and BSMP to delay output by 8.33ns unit



**Offset 7Eh ..... Default value = 8'h00**

X	X	GPOLED18	GPOLED17	GPOLED16	GPOLED15	GPOLED14	GPOLED13
X	X	R/W	R/W	R/W	R/W	R/W	R/W

- 7-6 RESERVED -
- 5 GPOLED18 0 GPIO18 as general I/O.  
1 GPIO18 as LED outout.
- 4 GPOLED17 0 GPIO17 as general I/O.  
1 GPIO17 as LED outout.
- 3 GPOLED16 0 GPIO16 as general I/O.  
1 GPIO16 as LED outout.
- 2 GPOLED15 0 GPIO15 as general I/O.  
1 GPIO15 as LED outout.
- 1 GPOLED14 0 GPIO14 as general I/O.  
1 GPIO14 as LED outout.
- 0 GPOLED13 0 GPIO13 as general I/O.  
1 GPIO13 as LED outout.

**Offset 7Fh ..... Default value = 8'h00**

BSMPDLY1	BSMPDLY0	VSMPDLY1	VSMPDLY0	LEDCNT3	LEDCNT2	LEDCNT1	LEDCNT0
R/W	R/W	R/W	R/W	R/W	R/W	R/W	R/W

- 7-6 BSMPDLY[1:0] To set BSMP output delay.  
00 No delay.  
01 Delay 8.33ns  
10 Delay 16.67ns  
11 Delay 25ns.
- 5-4 VSMPDLY[1:0] To set VSMP output delay.  
00 No delay.  
01 Delay 8.33ns  
10 Delay 16.67ns  
11 Delay 25ns.
- 3-0 LEDCNT[1:0] To set LED blinking speed.  
The unit is 100ms.

**Offset 80h ..... Default value = 8'h00**

VRHOME1	VRHOME0	VRMOVE1	VRMOVE0	VRBACK1	VRBACK0	VRSCAN1	VRSCAN0
R/W	R/W	R/W	R/W	R/W	R/W	R/W	R/W

- 7-6 VRHOME[1:0] To set the Vref. of the motor driver IC for go-home moving.
- 5-4 VRMOVE[1:0] To set the Vref. of the motor driver IC for fast forward moving.
- 3-2 VRBACK[1:0] To set the Vref. of the motor driver IC for backward moving.
- 1-0 VRSCAN[1:0] To set the Vref. of the motor driver IC for scan forward moving.

**Offset 81h ..... Default value = 8'h00**

X	X	X	X	X	X	X	ROFFSET8
X	X	X	X	X	X	X	R/W

- 7-1 RESERVED -
- 0 ROFFSET8 To set R Channel Offset of the AFE for CIS color scan.



**Offset 82h ..... Default value = 8'h00**

ROFFSET7	ROFFSET6	ROFFSET5	ROFFSET4	ROFFSET3	ROFFSET2	ROFFSET1	ROFFSET0
R/W	R/W	R/W	R/W	R/W	R/W	R/W	R/W

**7-0 ROFFSET[7:0]** To set R Channel Offset of the AFE for CIS color scan.

**Offset 83h ..... Default value = 8'h00**

X	X	X	X	X	X	X	GOFFSET8
X	X	X	X	X	X	X	R/W

**7-1 RESERVED** -  
**0 GOFFSET8** To set G Channel Offset of the AFE for CIS color scan.

**Offset 84h ..... Default value = 8'h00**

GOFFSET7	GOFFSET6	GOFFSET5	GOFFSET4	GOFFSET3	GOFFSET2	GOFFSET1	GOFFSET0
R/W	R/W	R/W	R/W	R/W	R/W	R/W	R/W

**7-0 GOFFSET[7:0]** To set G Channel Offset of the AFE for CIS color scan.

**Offset 85h ..... Default value = 8'h00**

X	X	X	X	X	X	X	BOFFSET8
X	X	X	X	X	X	X	R/W

**7-1 RESERVED** -  
**0 BOFFSET8** To set B Channel Offset of the AFE for CIS color scan.

**Offset 86h ..... Default value = 8'h00**

BOFFSET7	BOFFSET6	BOFFSET5	BOFFSET4	BOFFSET3	BOFFSET2	BOFFSET1	BOFFSET0
R/W	R/W	R/W	R/W	R/W	R/W	R/W	R/W

**7-0 BOFFSET[7:0]** To set B Channel Offset of the AFE for CIS color scan.

**Offset 87h ..... Default value = 8'h00**

X	YENB	YBIT	ACYCNRLC	ENOFFSET	LEDADD	CK4ADC	AUTOCONF
X	R/W	R/W	R/W	R/W	R/W	R/W	R/W

- 7 RESERVED** -
- 6 YENB** 0 To disable PH\_Y output of the YBIT.  
1 To enable PH\_Y output of the YBIT.
- 5 YBIT** to output PH\_Y status.
- 4 ACYCNRLC** 0 To disable this function.  
1 To generate RLC/ACYC pulse to trigger WM8199 auto-cycling for Line-by-line color scanning.
- 3 ENOFFSET** 0 To disable this function.  
1 To select automatic offset configuration for CIS scanning.

- 2 LEDADD**      0 Normal gray by controlling CIS single color LED array.  
                      1 Enable true gray by controlling CIS RGB LED array.
- 1 CK4ADC**      0 To select ADCCLK output by default.  
                      1 To select ADCCLK output by CK4MAP setting.
- 0 AUTOCONF**   0 To disable these function.  
                      1 To enable automatic channel,offset configuration or or RLC/ACYC pulsing for CIS color scan.

Note: If YBIT=1,then YENB=1 PH\_Y=1;YENB=0 PH\_Y=0.  
If YBIT=0,then YENB=1 PH\_Y=0;YENB=0 PH\_Y=1.

### 4.3 Register Mapping

#### 4.3.1 Shading Mapping (Chunky for Single Bank)

**Table 4.2 - Shading Mapping (Chunky for Single Bank)**

Attribute	Resolution	Address[19:0]
Shading Mapping	600dpi (DPIHW=00)	00000H~07FFFH SIZE : 32k
	1200dpi (DPIHW=01)	00000H~0FFFFH SIZE : 64k
	2400dpi (DPIHW=10)	00000H~1FFFFH SIZE : 128k

#### 4.3.2 Shading Mapping (Planer)

**Table 4.3 - Shading Mapping (Planer)**

Attribute	Resolution		Address[19:0]
Shading Mapping	600dpi (DPIHW=00)	Red Channel	00000H~029FFFH
		Green Channel	02A00H~053FFFH
		Blue Channel	05400H~07DFFFH
	1200dpi (DPIHW=01)	Red Channel	00000H~054FFFH
		Green Channel	05500H~0A9FFFH
		Blue Channel	0AA00H~0FEFFFH
	2400dpi (DPIHW=10)	Red Channel	00000H~0A7FFFH
		Green Channel	0A800H~14FFFH
		Blue Channel	15000H~1F7FFFH

### 4.3.3 Slope Curve Table Mapping

**Table 4.4 - Slope Curve Table Mapping**

Attribute	Resolution	Table No.	Address[19:0]
Slope Curve Table	600DPI (DPIHW=00)	Table 1	08000 ~ 081FF
		Table 2	08200 ~ 083FF
		Table 3	08400 ~ 085FF
		Table 4	08600 ~ 087FF
		Table 5	08800 ~ 089FF
	1200DPI (DPIHW=01)	Table 1	10000 ~ 101FF
		Table 2	10200 ~ 103FF
		Table 3	10400 ~ 105FF
		Table 4	10600 ~ 107FF
		Table 5	10800 ~ 109FF
	2400DPI (DPIHW=10)	Table 1	20000 ~ 201FF
		Table 2	20200 ~ 203FF
		Table 3	20400 ~ 205FF
		Table 4	20600 ~ 207FF
		Table 5	20800 ~ 209FF

### 4.3.4 Image Buffer Mapping

**Table 4.5 - Image Buffer Mapping**

Attribute	Resolution	Address[19:0]
DRAM/SRAM 4M BITS X 1	600DPI (DPIHW=00)	09000H~3FFFFH
	1200DPI (DPIHW=01)	11000H~3FFFFH
	2400DPI (DPIHW=10)	21000H~3FFFFH
DRAM 4M BITS X 2 or 8M BITS SRAM	600DPI (DPIHW=00)	09000H~7FFFFH
	1200DPI (DPIHW=01)	11000H~7FFFFH
	2400DPI (DPIHW=10)	21000H~7FFFFH
DRAM 16M BITS	600DPI (DPIHW=00)	09000H~FFFFFFH
	1200DPI (DPIHW=01)	11000H~FFFFFFH
	2400DPI (DPIHW=10)	21000H~FFFFFFH

## CHAPTER 5 BLOCK DIAGRAM

### 5.1 USB2.0 System Block Diagram

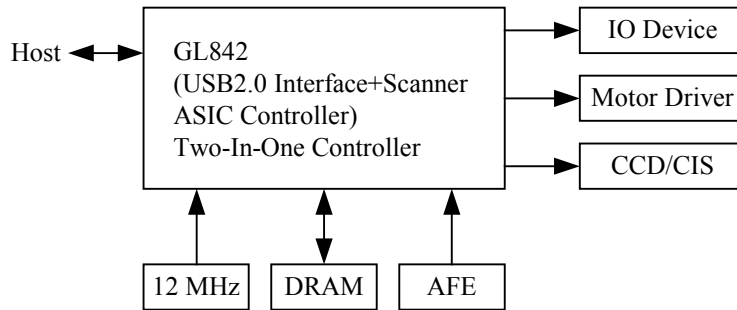

Figure 5.1 - USB2.0 System Block Diagram

### 5.2 Function Block Diagram

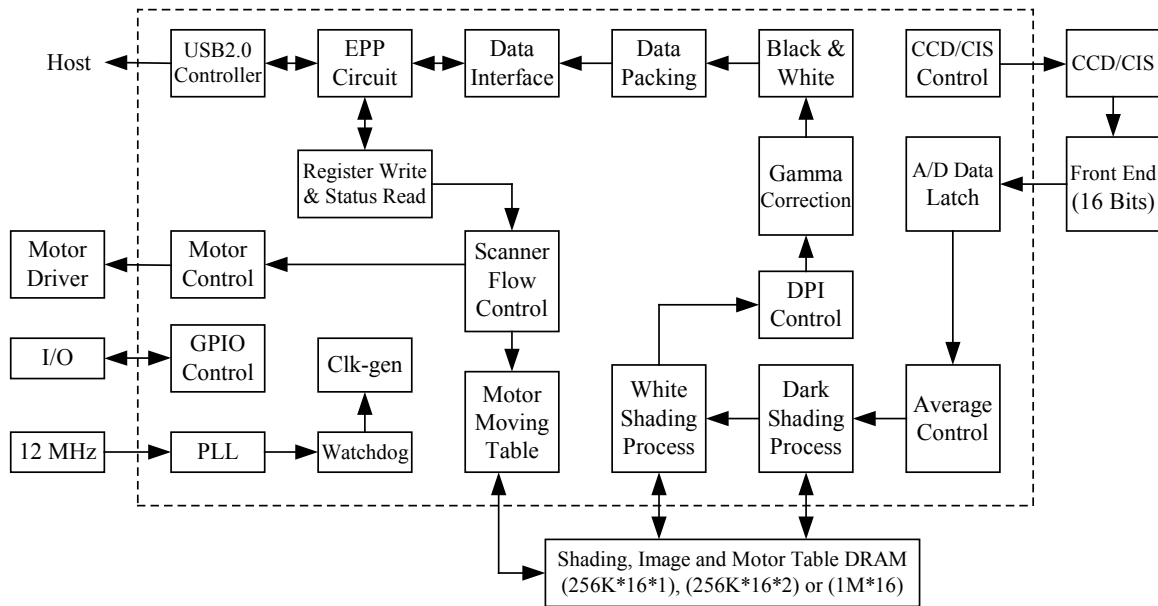

Figure 5.2 - Function Block Diagram



## CHAPTER 6 FUNCTIONAL DESCRIPTION

### 1 System Clock

Internal PLL.

A. PLL: 12MHz input, 24, 30, 40 MHz output to internal system .

### 2 Pixel Clock

A. Normal mode

- Scan mode 0:  
(three-line-in or one-line-in)
- a. 12 system clock/pixel.
  - b. Chunky color(three line in),fine-gray or fine-line-art scan for CCD.
  - c. Planar color scan (one line in) or Monochrome scan for CIS.

B. Fast mode

- Scan mode 4 (one line in):
- a. 6 system clock/pixel.
  - b. Planar color scan (one line in) or Monochrome scan.
  - c. Fast-gray or fast-line-art scan for CCD.
  - d. Planar color(one line in),gray, true gray or line-art scan for CIS.

C. Scan mode 5 (three line in):

- a. 15 system clock/pixel
- b. Chunky color(three line in),fine-gray or fine-line-art scan for CCD.
- c. Planar color scan (one line in) or Monochrome scan for CIS.

D. Scan mode 6 (three line in):

- a. 18 system clock/pixel.
- b. Chunky color(three line in),fine-gray or fine-line-art scan for CCD.
- c. Planar color scan (one line in) or Monochrome scan for CIS.

Note: Chunky Color is R1G1B1, R2G2B2, R3G3B3,.....(three-line-in or pixel rate)

Planar Color is R1, R2, R3,.....;G1,G2,G3,.....;B1,B2,B3,.....(one-line-in or line rate)

CCD: Chunky color or planar color.

CIS: Planar color

### 3 Scan Speed

A. System clock = 30MHz:

- a. Normal Mode: Chunky color, fine gray or fine line art scan.  
(scan mode 0)  $12 \times 33.333\text{ns/pixel} = 0.4\mu\text{s/pixel}$ 
  - (1). 600dpi: 2.160ms/line, 15.163s/page.
  - (2). 1200dpi: 4.320ms/line, 60.653s/page.
- b. Fast Mode: Planar color , fast gray or fast line art scan.  
(scan mode 4)  $6 \times 33.333\text{ns/pixel} = 0.2\mu\text{s/pixel}$ 
  - (1). 600dpi: 1.08ms/line, 7.582s/page for fast gray or fast line art.
  - (2). 1200dpi: 2.160ms/line, 30.326s/page for fast gray or fast line art.

B. System clock = 40MHz:

- a. Normal Mode: Chunky color, fine gray or fine line art scan.  
 $12 \times 25\text{ns/pixel} = 0.3\mu\text{s/pixel}$ 
  - (1). 600dpi: 1.620ms/line, 11.372s/page.
  - (2). 1200dpi: 3.240ms/line, 45.488s/page.
- b. Fast Mode: Planar color , fast gray or fast line art scan.  
 $6 \times 25\text{ns/pixel} = 0.15\mu\text{s/pixel}$ 
  - (1). 600dpi: 0.81ms/line, 5.616s/page for fast gray or fast line art.
  - (2). 1200dpi: 1.62ms/line, 22.744s/page for fast gray or fast line art.

### 4 Fast Scan for Low DPI

Speed up CCD clocking rates allows speeding up scanning speed.  
 Such as Stagger CCD, you can speed up 2 times, 4 times scanning time for low resolution as 600dpi  
 Scanner: if 75dpi speed up 4 times then  $1.620\text{ms}/4=0.405\text{ms}/\text{line}$ .  
 Scan speed is equal to 0.355s/page.

### 5 Scanning Type

Support three line in(parallel ) for CCD, one line in for CIS two types.

#### A. CCD

a. Three line in:

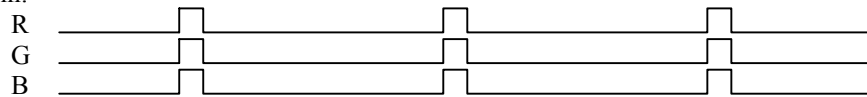

a. Line by line:



#### B. CIS

a. Color scan:

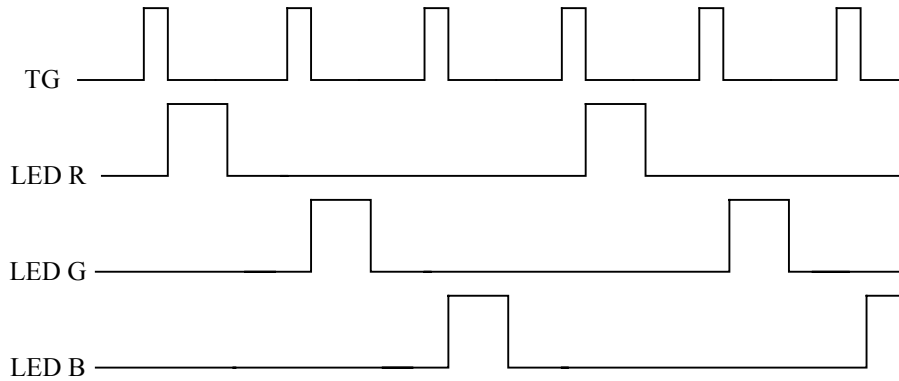

b. Gray scan:

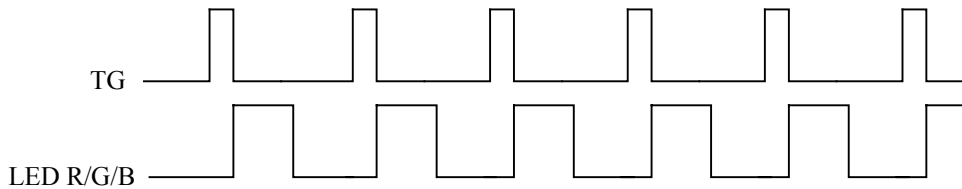

c. True gray scan:

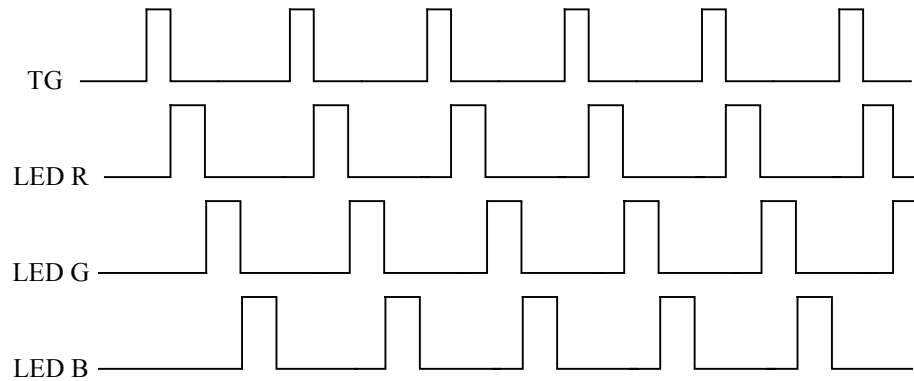





## 6 Image Sensor Timing

Can be programmed.

- A. CCD: support 600,1200 or 2400 dpi CCD.  
For example NEC, TOSHIBA, Sony .....etc.
- B. CIS: support 600,1200 or 2400 dpi CIS.  
For example Toshiba , Canon.....etc.

## 7 Dummy Line

Support programmable dummy lines to resolve (overcome) Start/Stop problem.

You can insert dummy lines to reduce scanner stop and wait events (buffer full) or always non-stop.

- A. Line base of dummy lines: The range of dummy lines is 0 line ~ 15 lines.
- B. Adjustable dummy line: The range is CCD or CIS minimum shift out time to 2096k pixels time, which can be adjusted by 1 pixel time increment.

## 8 Analog Front End Timing

External 16 bits Front-End for Wolfson WM8192, WM8199.....etc.

## 9 Image Type

Support color, fine gray, fine line art, fast gray and fast line art scan.

Support color filters selection for gray and line art scans. The filters include Red, Green and Blue.

Note: The scan style of fine line art, fine gray or color are the same. So fine gray or fine line art scanning speed is slow.

## 10 Bits Depth

16 x3 Bits true color , 16 bits gray level and one bit line art(Black & White).

Image data type: 16 bits , 8 bits and 1 bit data type.

## 11 Shading & Correction

16 x3 Bits true color , 16 bits gray level and one bit line art(Black & White).

### A. White Shading & Dark Shading:

Internal white shading by pixel (16 bits resolution) and dark shading by pixel (16 bits resolution), can be Enabled or disabled By S/W.

Data arrangement: three line in mode: dark R1, white R1,dark G1,white G1,dark B1,white B1,  
dark R2,white R2,dark G2,white G2,dark B2,white B2,  
dark R3,white R3,dark G3,white G3,dark B3,white B3,.....  
one line in mode: dark R1,white data R1,dark R2,white R2,dark R3, white R3...  
dark G1,white data G1,dark G2,white G2,dark G3,white G3...  
dark B1,white data B1,dark B2,white B2,dark B3,white B3...

White shading formula:  $2000H \times \text{Target} / (Wn-Dn) = \text{White Gain data -----}$  for 8 times system

White shading formula:  $4000H \times \text{Target} / (Wn-Dn) = \text{White Gain data -----}$  for 4 times system

For example: Target = 3FFFH Wn = 2FFFH Dn = 0040H and 8 times system operation  
then White Gain =  $2000H \times 3FFFH / (2FFFH-0040H) = 2AE4H$  (1.34033 times)

### B. Gamma Correction:

GAMMA correction table is calculated by S/W. The resolution is 16 bits gamma table.

Range: 0 to 64k (16 bits) input map 0 to 255 (8 bits) output.

Style: increment or decrement gamma curve style.

Note: If you bypass gamma correction, you can get 16 bits image data.

If you enable gamma correction, you can get 8 bits image data.

## 12 Threshold Level Setting

Can be programmed by S/W.

Range: 0 to 255 can be adjusted by one increment.

The threshold with bandwidth is in order to reduce image noise.

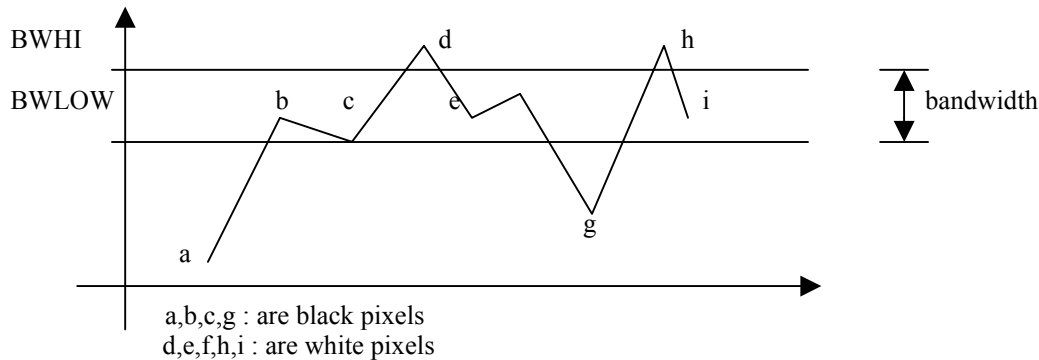

## 13 Exposure Time Adjustable

Maximum: 2096k pixels time

Adjustment step: 1 pixel time.

For transparency scan, the exposure time can up to 2096k pixel time.

## 14 Scan Width control

Scan width control for horizontal line.

A. Support start pixel address, end pixel address and dummy pixel number setting.

B. Maximum length: 64k pixels.

Minimum length: 1 pixel.

## 15 Support built-in USB(2.0)

A. Two in one: USB2.0 + scanner controller.

## 16 DRAM Timing

Support 4Mx1 , x2 Bits (256Kx16) or 16M Bits (1Mx16) for EDO DRAM ; 4M or 8M Bits for SRAM, as image buffer and calibration buffer timing.

You can select single or double DRAM for scanner. DRAM speed is 28ns and above for 30MHz system clock, 25ns and above for 40MHz system clock.

## 17 Horizontal Resolution Adjustable for DPI Function

A. Digital deletion type: The resolution from 1 DPI to 2400 DPI , can be adjusted by 1 DPI increment by S/W.

B. Digital average type: Support 1/2,1/3,1/4,1/5,1/6,1/8,1/10,1/12,1/15 digital average function.

For example, 1200dpi scanner: 600dpi, 400dpi, 300dpi, 240dpi, 200dpi, 150dpi, 120dpi, 100dpi, 80dpi average function.

C. Support stagger CCD: Support 1/2, 1/4 resolution, such as NEC, Toshiba and Sony stagger CCD.

## 18 Vertical Resolution Adjustable for DPI Function

The resolution of motor speed control is 16 bits, therefore we can control vertical resolution.

By one dpi increment, the resolution can be from 1 DPI to 4800 DPI for 1200 DPI scanner; and 1 DPI to 9600 DPI for 2400 DPI scanner.

Note: The resolution of quarter step can up to four times resolution.

### 19 Acceleration/Deceleration Five Table

The acceleration/deceleration slope tables are stored in DRAM, can be download by S/W.

The slope can be programmed by S/W for each table. Resolution is 16 bits pixel-time. The number of slope steps is 1~512 steps. There are five tables for motor moving. Three tables are for scanning and the others are for fast moving. The forward and backward steps can be programmed by S/W. The resolution is 16 bits pixel-time. The number of slope steps is 1~512 steps. You can adjust any nonlinear curve.

Note: what is fast move? Such as move back to go-home or move to scan window in any position.

(1) Two tables go to scan:

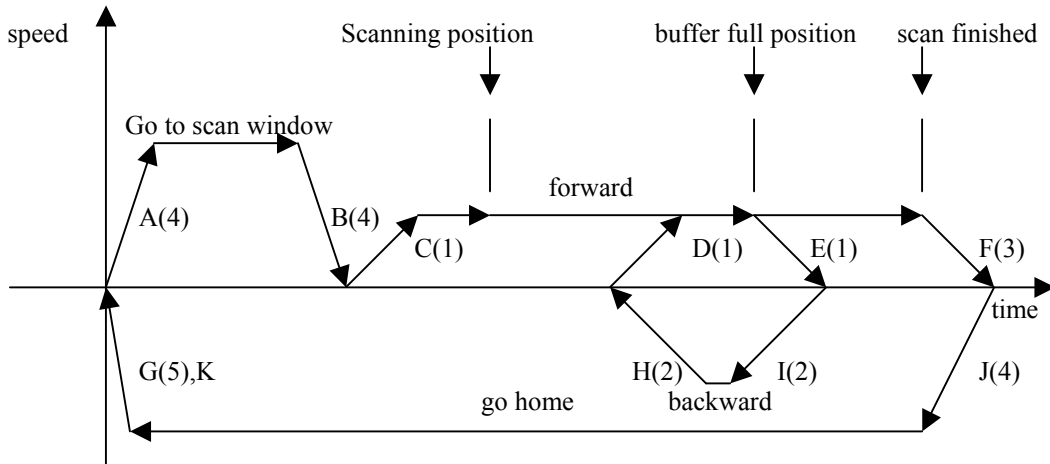

- A,J : table four (slope four) acceleration curve for fast moving.
- B : table four (slope four) deceleration curve for fast moving.
- C,D : table one (slope one) acceleration curve for scanning forward.
- F : table three (slope three) deceleration curve for scanning finish.
- I : table two (slope two) acceleration curve for scanning backward.
- H : table two (slope two) deceleration curve for scanning backward.
- G : table five (slope five) deceleration curve for go-home.
- K : touch home sensor deceleration curve for go-home.

(2) One tables go to scan:

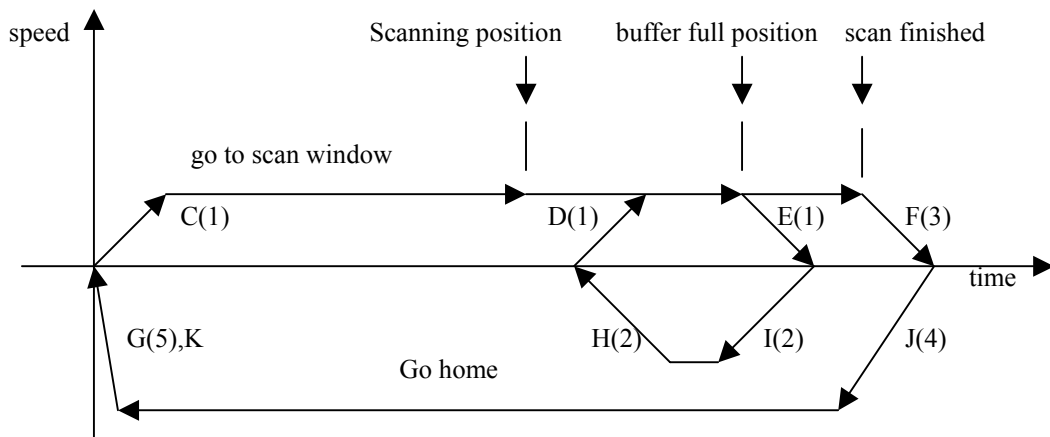

- J : table four (slope four) acceleration curve for fast moving.
- C,D : table one (slope one) acceleration curve for scanning forward.
- F : table three (slope three) deceleration curve for scanning finish.
- I : table two (slope two) acceleration curve for scanning backward.
- H : table two (slope two) deceleration curve for scanning backward.
- G : table five (slope five) deceleration curve for go-home.
- K : touch home sensor deceleration curve for go-home.

## 20 Stepping Motor Phase Control

There is 8 output control pins to control stepping motor. mtr\_ph0~7 for bi-polar and mtr\_ph0~3 for uni-polar.

### A. bi-polar:

- a. Support 2916 motor driver timing and 2916 compatible driver IC, such as L6219.  
Include full, half and quarter step control.
- b. Support 3955 motor driver timing.  
Include full, half, quarter and eighth step control.
- c. Support LB1939, LB1940 motor driver timing.  
Include full and half step control.

### B. uni-polar:

- a. Support 2003 motor driver timing and 2003 compatible driver IC.
- b. Include full step two phases on, full step single phase on and half step.
- c. PWM control, include frequency and duty control.

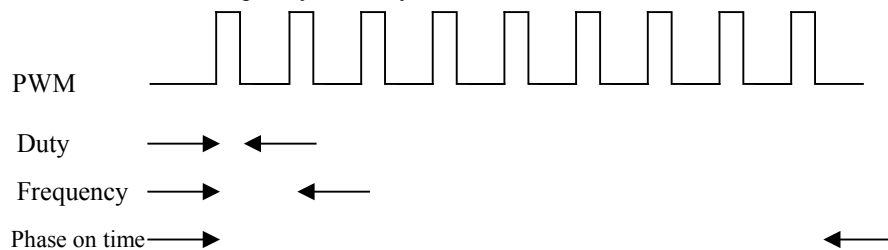

## 21 Watch-Dog Protection

This function can automatically reset the system to initial state, whenever the system is held (no access signal) beyond the time limit. Be able to enable or disable this function by S/W.

This function can protect motor power, lamp power and ASIC system.

Calculation formula: (30sec.) \* (times setting) \* (setting no.).

The range of setting no. is 1~15; the range of times setting is 0~1.

## 22 Lamp Timeout Control

This circuitry can automatically reset the lamp power, whenever the system is setting. Be able to enable or disable this function by S/W.

Calculation formula: (60sec.) x (times setting) x (setting no.).

The range of setting no. is 1~7; the range of times setting is 0~3.

## 23 Lamp Power Control

These are two power control ports for lamp. One is for Flatbed and the other is for XPA (Transparency or film).

The resolution of its PWM type is 8 bits. Duty range is 1/256~256/256.

Note: carrier frequency is (system clock)/256.

## 24 Sensor Input

The system support home sensor input port.



### 25 16 GPIO Ports

You can set input or output for each GPIO pin of the GPIO1~16 separately.

Such as keypads inputs, document sensor for sheet-fed or motor power control...etc.

Note : there are two pins for special function. One is GPIO12 and the other is GPIO11.

- GPIO12:
1. Pull up by resistor to indicate that ASIC turn on lamp power whenever power on initial.
  2. Pull down by resistor to indicate that ASIC turn off lamp power whenever power on initial.
  3. This pin can control bi-polar motor driver 2916,6219,3966 or 3955 Vref in order to control I<sub>max</sub>. current.

GPIO11: This pin can control bi-polar motor driver 2916,6219,3966 or 3955 Vref in order to control I<sub>max</sub>. current.

### 26 GPO17~18 Ports or Motor MTR\_PH6~7 Two Phase

You can select 2 pins for 3955 2 phase MTR\_PH6~7 output or GPO17~18 output.

### 27 GPO13 Port or Motor Trigger Signal for ADF

Motor trigger signal for ADF motor moving. It can be controlled under scanning condition.

### 28 Power on Check

The default status of the PWRBIT is reset. You can set the PWRBIT and then read back the status in order to check the power status. This operation is able to check first time power on or not.

### 29 RAM Test

S/W can test DRAM/SRAM IC by writing and reading back for checking.

### 30 LED Blinking

Support LED-blinking function. It is implemented in GPIO13~18 pins.

### 31 Support Back Scanning

Support forward or backward scanning type.

## CHAPTER 7 ELECTRICAL CHARACTERISTICS

### 7.1 Absolute Maximum Ratings (Voltage Referenced to GND)

**Table 7.1 - Absolute Maximum Ratings (Voltage Referenced to GND)**

Symbol	Description	Min	Max
DVCC0 DVCC1 AVDD AVCC1 VccCore1~4	DC supply voltage	-0.5V	+3.6V
VccIO1~6	DC supply voltage	-0.5V	+3.6V or +5.5V
V <sub>I</sub>	DC input voltage	-0.5V	VCC+0.5V
V <sub>I/O</sub>	DC input voltage range for I/O	-0.5V	VCC+0.5V
V <sub>AI/O</sub>	DC input voltage for USB D+/D- pins	-0.5V	VCC+0.5V
V <sub>I/OZ</sub>	DC voltage applied to outputs in High Z state	-0.5V	VCC+0.5V
T <sub>STQ</sub>	Storage temperature range	-60°C	+150°C
T <sub>amb</sub>	Operating ambient temperature	0°C	70°C
V <sub>ESD</sub>	Static discharge voltage	4000V	

Note: VCC: VccCore, VccIO, DVCC, AVDD or AVCC1

### 7.2 DC Characteristics (Digital Pins): 3.3 V Logic Core or Pads

**Table 7.2 - DC Characteristics (Digital Pins): 3.3 V Logic Core or Pads**

SYMBOL	Description	Min	Typ.	Max	Unit
P <sub>D</sub>	Power Dissipation				mA
DVCC0 DVCC1 AVDD AVCC1 VccCore1~4	Power Supply Voltage	3.1	3.3	3.6	V
VccIO1~6	Power Supply Voltage 3.3V	3	3.3	3.6	V
I <sub>O</sub>	DC output sink current excluding D+/D-/VCC/GND	16 or 8			mA
V <sub>IL</sub>	LOW level input voltage			0.9	V
V <sub>IH</sub>	HIGH level input voltage	2.0			V
V <sub>TLH</sub>	LOW to HIGH threshold voltage	1.3	1.43	1.56	V
V <sub>THL</sub>	HIGH to LOW threshold voltage	1.3	1.43	1.56	V
V <sub>HYS</sub>	Hysteresis voltage	-	0	-	V
V <sub>OL</sub>	LOW level output voltage when I <sub>OL</sub> =16mA			0.4	V
V <sub>OH</sub>	HIGH level output voltage when I <sub>OH</sub> =16mA	2.4			V
I <sub>OLK</sub>	Leakage current for pads with internal pull up or pull down resistor			46	μA
R <sub>DN</sub>	Pad internal pulldown resistor	72.8K	105.7K	167.4K	Ω
R <sub>UP</sub>	Pad internal pullup resistor	135.9K	167.8K	212.4K	Ω

Note: hbd16dhk is internal pulled down; hbd16uhk is internal pulled up; hbd16\* is 16mA; hbd8\* is for 8mA

**7.3 DC Characteristics (Digital Pins): 5.0 V Pads**
**Table 7.3 - DC Characteristics (Digital Pins): 5.0 V Pads**

SYMBOL	Description	Min	Typ.	Max	Unit
$P_D$	Power Dissipation				mA
VccIO1~6	Power Supply Voltage 5.0V	4.5	5.0	5.5	V
$I_O$	DC output sink current excluding D+/D-/VCC/GND	16			mA
$V_{IL}$	LOW level input voltage			0.9	V
$V_{IH}$	HIGH level input voltage	2.4			V
$V_{TLH}$	LOW to HIGH threshold voltage				V
$V_{THL}$	HIGH to LOW threshold voltage				V
$V_{OL}$	LOW level output voltage when $I_{OL}=8mA$			0.4	V
$V_{OH}$	HIGH level output voltage when $I_{OH}=8mA$	2.4			V
$I_{OLK}$	Leakage current for pads with internal pull up or pull down resistor			46	$\mu A$
$R_{DN}$	Pad internal pulldown resistor	104.6K	159.5K	206.6K	$\Omega$
$R_{UP}$	Pad internal pullup resistor	81.9K	103.2K	254.6K	$\Omega$

**7.4 DC Characteristics (D+/D-)**
**Table 7.4 - DC Characteristics (D+/D-)**

SYMBOL	Description	Min	Typ.	Max	Unit
$V_{OL}$	D+/D- static output LOW ( $R_L$ of 1.5K to 3.6V )			0.3	V
$V_{OH}$	D+/D- static output HIGH ( $R_L$ of 15K to GND )	2.8		3.6	V
$V_{DI}$	Differential input sensitivity	0.2			V
$V_{CM}$	Differential common mode range	0.8		2.5	V
$V_{SE}$	Single-ended receiver threshold	0.2			V
$C_{IN}$	Transceiver capacitance			20	pF
$I_{LO}$	Hi-Z state data line leakage	-10		+10	$\mu A$
$Z_{DRV}$	Driver output resistance	28		43	$\Omega$

## CHAPTER 8 PACKAGE DIMENSION

**QFP-128L (14\*20 mm, F/P: 3.2 mm):**

SYMBOLS	MIN(mm)	NOM(mm)	MAX(mm)
A1	0.25	0.35	0.45
A2	2.57	2.72	2.87
b	0.10	0.20	0.30
C	0.10	0.15	0.20
D	13.90	14.00	14.10
E	19.90	20.00	20.10
e	-	0.50	-
Hd	17.00	17.20	17.40
He	23.00	23.20	23.40
L	0.65	0.80	0.95
L1	-	1.60	-
Y	-	-	0.08
$\theta$	0	-	12

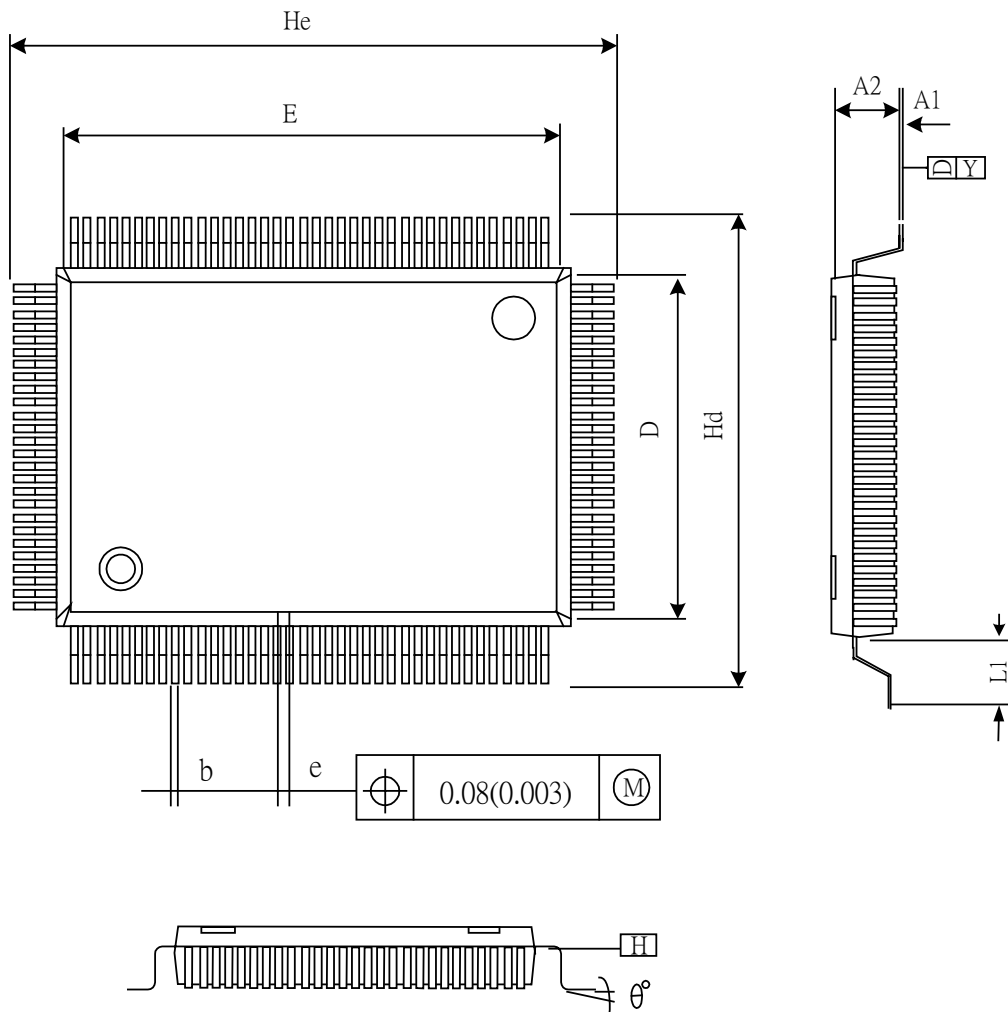

**Figure 8.1 - GL842 128 Pin QFP Package**