

## Open Carrier Double-Balanced Mixer For Microwave Telecommunications

**MC4507**  
V2

### Features

- LO & RF: 4.0 TO 20.0 GHz
- IF: DC TO 4.0 GHz
- LO DRIVE: +7 dBm (NOMINAL)
- MICROSTRIP INTERFACE

### Description

The MC4507 is a double balanced mixer, designed for use in military, commercial and test equipment applications. The design utilizes Schottky ring quad diodes and broadband soft dielectric and ferrite baluns to attain excellent performance. This mixer can also be used as a phase detector and/or bi-phase modulator since the IF port is DC coupled to the diodes. The use of high temperature solder and welded assembly processes used internally makes it ideal for use in manual, semi-automated assembly. Environmental screening available to MIL-STD-883, MIL-STD-202, or MIL-DTL-28837, consult factory.

### Product Image



### Ordering Information

Part Number	Package
MC4507	Open Carrier
MC4507-2	Open Carrier

### Electrical Specifications: $Z_0 = 50\Omega$ $Lo = +7$ dBm (Downconverter application only)

Parameter	Test Conditions	Units	Typical	Guaranteed	
				+25°C	-54° to +85°C
SSB Conversion Loss (max) & SSB Noise Figure (max)	fR = 6 to 18 GHz, fL = 6 to 18 GHz, fl = 0 to 2 GHz	dB	6.0	7.5	8.0
	fR = 6 to 18 GHz, fL = 6 to 18 GHz, fl = 0 to 4 GHz	dB	6.5	8.0	8.5
	fR = 4 to 20 GHz, fL = 4 to 20 GHz, fl = 0 to 4 GHz	dB	7.5	9.0	9.5
Isolation, L to R (min)	fL = 8 to 16 GHz	dB	35	25	23
	fL = 6 to 18 GHz	dB	30	18	16
	fL = 4 to 20 GHz	dB	20	12	10
Isolation, L to I (min)	fL = 8 to 16 GHz	dB	35	25	23
	fL = 6 to 18 GHz	dB	30	18	16
	fL = 4 to 20 GHz	dB	23	12	10
Isolation, R to I (min)	fL = 4 to 20 GHz	dB	35		
1 dB Conversion Comp.	fL = +7 dBm	dBm	+0		
Input IP3	fR1 = 8.4 GHz at -5 dBm, fR2 = 8.42 GHz at -5 dBm, fL = 8.6 GHz at +7 dBm	dBm	+10		
	fR1 = 14.4 GHz at -5 dBm, fR2 = 14.42 GHz at -5 dBm, fL = 15.4 GHz at +7 dBm	dBm	+11		

**Open Carrier Double-Balanced Mixer  
For Microwave Telecommunications**

**MC4507**  
V2

**Typical Performance Curves**

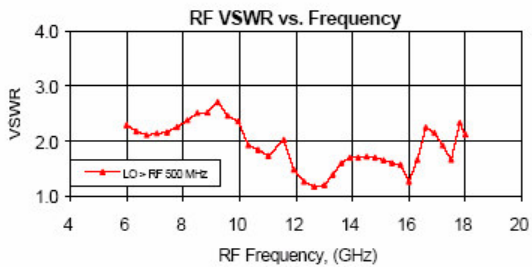
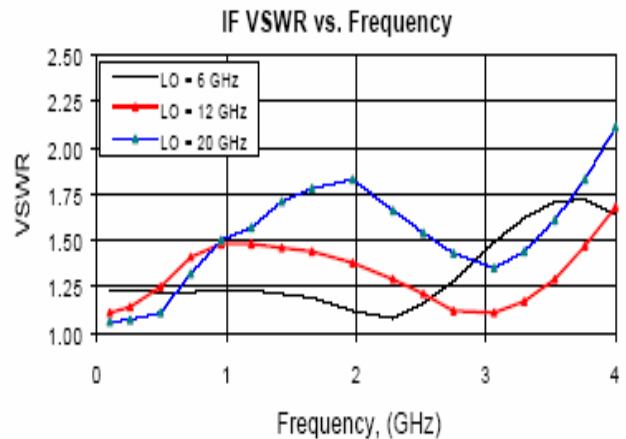
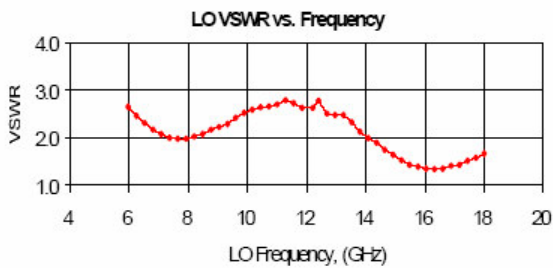
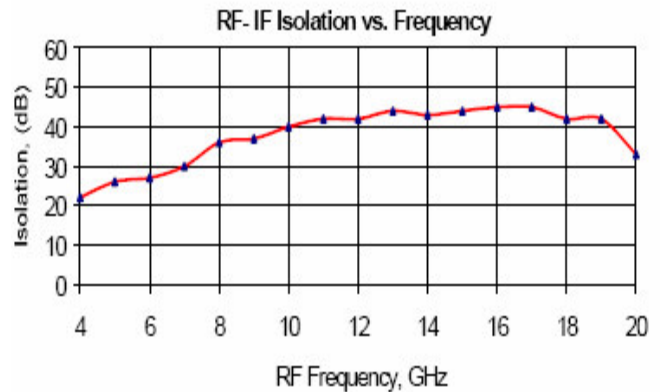
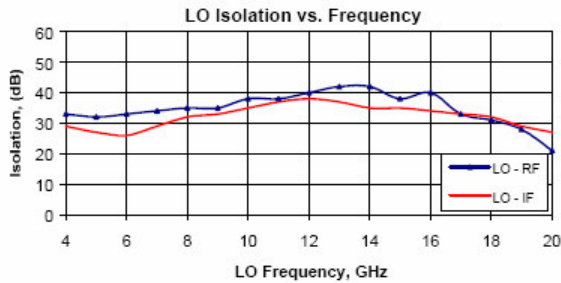
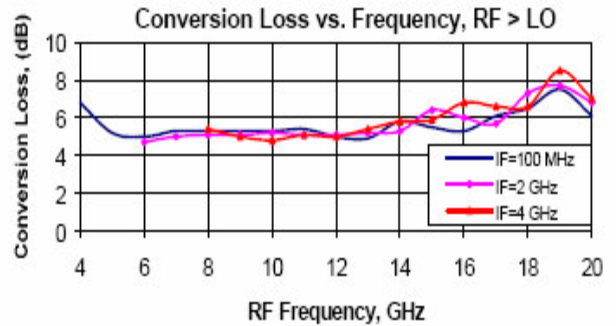
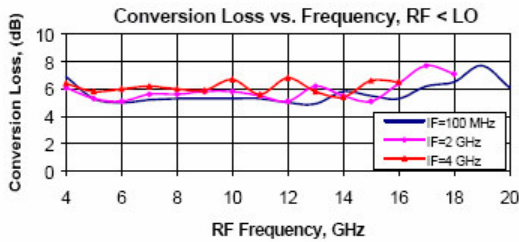

**Open Carrier Double-Balanced Mixer  
For Microwave Telecommunications**

**MC4507**  
V2

**Absolute Maximum Ratings**

Parameter	Absolute Maximum
Operating Temperature	-40°C to +85°C
Storage Temperature	-65°C to +100°C
Peak Input Power	+20 dBm max @ +25°C +17 dBm max @ +85°C
Peak Input Current	50 mA DC

**Outline Drawing: Open Carrier\* MC4507**

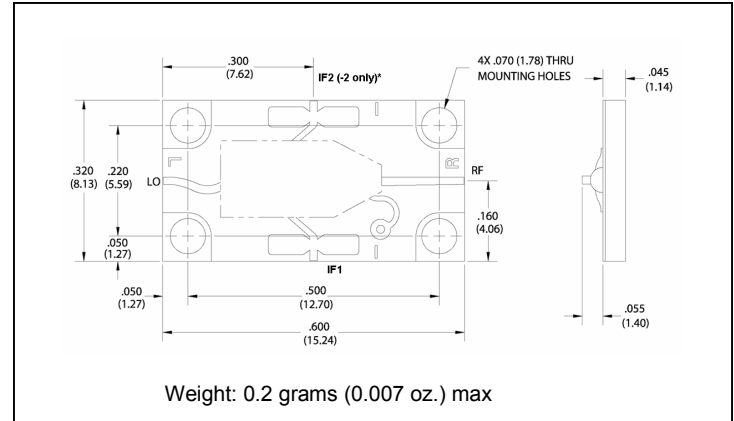

\*For the base model, only the IF1 port is connected.  
For the “-2” model, only the IF2 port is connected.

\* Dimensions are inches (millimeters) ±0.015 (0.38) unless otherwise specified.